



The National Coal Council

Power for America from America

THE URGENCY OF SUSTAINABLE COAL

The National Coal Council

May 2008

CHAIR

Georgia R. Nelson
PTI Resources, Inc.

VICE CHAIR

Michael G. Mueller
Ameren Energy Fuels & Services Company

COAL POLICY COMMITTEE CHAIR

Fredrick D. Palmer
Peabody Energy

Library of Congress Catalog # (NOTE: NCC will provide)

THE NATIONAL COAL COUNCIL

Georgia R. Nelson
CHAIR
Robert A. Beck
EXECUTIVE DIRECTOR

U. S. DEPARTMENT OF ENERGY
Samuel W. Bodman
SECRETARY OF ENERGY

NOTE: Just below the Secretary's name should be a small box that tells what the Council is. The text that goes in that box is:

The National Coal Council is a Federal Advisory Committee to the Secretary of Energy. The sole purpose of The National Coal Council is to advise, inform, and make recommendations to the Secretary of Energy on any matter requested by the Secretary relating to coal or the coal industry.

NOTE: Next comes the transmittal letter that still needs to be drafted. Then at the end of the body of the report we have a series of Appendices (again, Pam can provide most of that), then the back cover which just has the Council's contact information in the middle at the bottom like this:

The National Coal Council
1730 M Street, NW
Suite 907
Washington, DC 20036
www.nationalcoalcoalouncil.org

THE URGENCY OF SUSTAINABLE COAL

Executive Summary

The National Coal Council has laid out a coherent strategy.

Over the past five years, the National Coal Council (NCC) has submitted a series of reports to the Secretary of Energy delineating how the United States can use coal to solve some of our most pressing energy needs regarding electricity, liquid fuel and natural gas.

In 2004, the Council produced *Opportunities to Expedite the Construction of New Coal-Based Power Plants*. This report emphasized: 1) The importance of streamlining the permitting process to meet increasing demand for electricity; 2) The strategic importance of integrated gasification combined cycle technology; and 3) The crucial need for continued research and development and technology demonstration projects — especially relating to clean coal technologies.

In 2006, the Council submitted *Coal: America's Energy Future* and stressed five fundamental points: 1) Coal is America's greatest energy resource; (2) Energy demand will continue to grow over the foreseeable decades; (3) Coal is the only domestic fuel with the flexibility and reserve base to meet that demand; (4) Coal conversion to electricity, liquid fuels and substitute natural gas would significantly increase supply and stabilize energy prices as well, and; (5) coal conversion would reinvigorate the industrial core of America, creating over 1.4 million new jobs and increasing the Gross Domestic Product (GDP) by at least \$3 trillion.

In 2007, the NCC built on the previous reports by completing *Technologies to Reduce or Capture and Store Carbon Dioxide Emissions*. That analysis presented a systematic suite of technologies to manage carbon dioxide (CO₂) emissions and pave the way for future generation, as well as coal gasification and liquefaction.

On October 12, 2007, the Secretary requested the National Coal Council conduct an additional study to “focus on several technological options to increase coal use consistent with the environmental goals of the country.” Pursuant to this request, the NCC submits the current report, *The Urgency of Sustainable Coal*. Significant energy-related events have occurred in the past several years that have far reaching implications for the United States and for the central role coal will play in the world's future. The present 2008 report follows the Secretary's directive and refines and extends the findings and recommendations in the earlier reports, particularly in regard: 1) Carbon management technologies; 2) Legal and regulatory issues; 3) Hybrid electric vehicles; 4) In-situ coal gasification and; 5) Converting coal to liquid fuel (CTL) and substitute natural gas (SNG).

Energy related events since 2006 underline the urgency of sustainable coal.

In the 2006 report, the Council delineated the potential of coal and predicted that energy supply problems, coupled with rising demand everywhere in the world, would lead to higher prices, increased dependence on foreign countries and significant socioeconomic costs. There is no question that these projections have come to pass. Since the beginning of 2006, for example:

- Oil prices increased from \$56 per barrel to over \$85 in January of 2008 and breeched \$120 by May. This headwind has significantly slowed economic growth and helped bankrupt six airlines in the past two years.
- Liquefied natural gas (LNG) has reached \$12-18 per thousand cubic feet (mcf) in many parts of the world as rising demand from Asia and Europe has dramatically reduced U.S. import expectations.
- Oil production has stagnated as even more of the world's top ten producers, Russia (2nd), Mexico (6th) and Norway (10th) now face the realities of depletion.
- Costs to produce energy have risen dramatically due to escalating prices for steel, materials, labor, equipment, transportation and energy itself.
- Ethanol produced from corn has come under attack across the world as food prices rise and there are street riots in several countries.

Despite these untoward, but not unexpected, events since 2006, some aspects of energy remain stable. In 2006, coal produced 50 percent of our electricity at a cost of about one fourth that of natural gas. In 2008, coal produces about 50 percent of our electricity at a cost even less than one fourth that of natural gas.

The Global Context of Energy Assures the Importance of Coal

Energy is the lifeblood of modern society as well as the means by which billions of women, men, and children across the world can escape the grip of poverty. Experience lights the way. In the 1930s, the United States employed the Rural Electrification Act to dramatically improve the quality of life of millions of Americans in small towns and villages, as well as those on farms and ranches. By 1949, two thirds (67 percent) of U.S. electricity came from coal. More recently, China has expanded access to electricity with 87 percent generated from coal to literally lift 400 million people out of poverty, leading the International Energy Agency (IEA) to state:

“Electrification in China is a remarkable success story [and] part of its poverty alleviation campaign... the most important lesson for other developing countries [is] that electrified countries reap great benefits, both in terms of economic growth and human welfare... China stands as an example.” IEA, 2007

Yet, despite these advances, much of the world remains in the energy backwater. Over 2 billion people live on less than two dollars a day, over two billion lack adequate access to electricity and another 1.6 billion have no electricity. Improved access to energy is the only hope the most prominent victims of energy deprivation — women and children — have of lessening the burden of unrelenting toil in the dark. Indeed, as the Global Energy Network (2004) has pointed out:

“Every single one of the United Nations’ Millennium Development Goals requires access to electricity as a necessary prerequisite.”

The present report further delineates the pathway by which current and emerging “green coal” technologies can be utilized to reduce greenhouse gas (GHG) emissions while enabling both advanced and developing nations to expand their economies and improve the quality of life. The urgency of sustainable coal is increasingly apparent as policymakers grapple with the twin challenges of protecting the environment while meeting the energy needs of a growing and dynamic world.

As a nation that is projected to import 62 percent of its liquid fuel, and 17 percent of its natural gas by 2015, the United States has an unremitting vested interest in the unfolding of the global energy drama. To set the conceptual framework of how the United States’ coal and technology fit into the global picture, this report is based upon ten fundamental premises:

1. Global demand for energy, particularly electricity, is growing at an unprecedented rate that will continue for decades.
2. Over 75 percent of the new demand for energy will come from non-OECD nations, especially from the Middle East, China, India and other parts of Asia as they seek to modernize.
3. Fossil fuels provide about 85 percent of the world’s energy and, according to the Energy Information Administration (EIA), in 2030, that figure will be still be about 85 percent—oil (32 percent), coal (28 percent) and natural gas (24 percent).
4. Systematically optimistic forecasts of energy production and prices have dimmed our understanding of the energy supply problems facing the world.
5. There is increasing evidence that oil and natural gas production will not keep pace with global demand.
6. Coal is irreplaceable as the cornerstone fuel of the future based on its strengths of supply, availability, versatility, affordability and emerging receptivity to carbon capture.
7. Coal-based generation is on the rise as over 660,000 megawatts of new coal power stations are planned or under construction.
8. Coal conversion to liquid fuels and SNG can alleviate emerging shortfalls in conventional production.
9. Clean coal technologies are continually evolving and allow for the consumption of more coal with greatly reduced criteria emissions.
10. Carbon Capture and Storage (CCS) will open up the full range of coal’s potential contribution to energy supply constraints across the world.

The United States has a unique opportunity to assume a leadership role in simultaneously reducing both GHG emissions and global poverty by making CCS and established clean coal technologies available, deployable and affordable to developing nations. The world is inevitably turning to coal conversion to meet escalating energy demand. China and India have only 4 percent of the world’s oil and natural gas. But with 2.5 billion people they have 37 percent of the population—and 23 percent of the world’s coal. It should be no surprise that coal is the fuel of choice for billions.

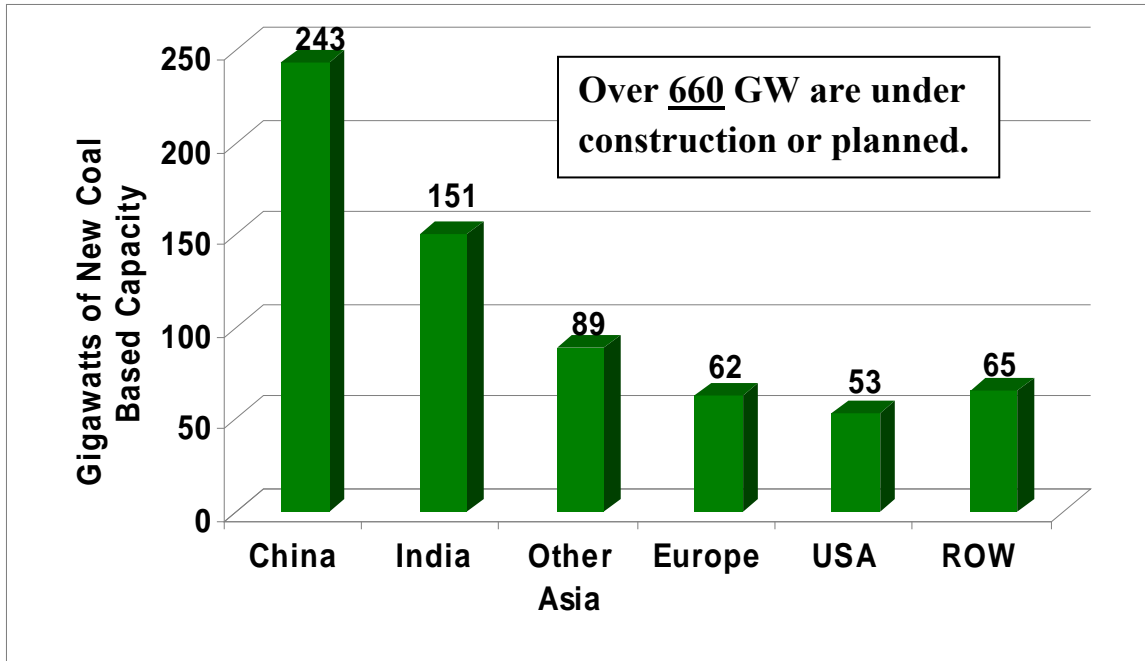

Figure ES.1. Coal-Based Generation Under Construction or Planned (Platts, 2008)

In short, coal is an inevitable, essential and productive part of the world’s energy future. The United States has the technology, resources and, as a global leader, the responsibility, to assure the process benefits both the environment and humankind.

Carbon Capture and Storage will open the door even wider

Carbon Capture and Storage (CCS) consists of technology to capture CO₂ from a fossil fuel utilization facility, compress the gaseous CO₂ into a dense fluid form, transport the CO₂ to a suitable storage site and inject the CO₂ into a porous geological formation where it will remain permanently. Captured CO₂ can also be used as an injection fluid to recover crude oil from depleted oil reservoirs.

In terms of coal, CCS is a technically viable solution for controlling CO₂ emissions from coal-based power generation, coal-to-liquid production and the production of SNG. At the present time, while there are no CCS applications at power plants, carbon capture is being implemented in oil and natural gas production, refining and industrial applications. CO₂ injection is being used for enhanced oil recovery.

Long term geologic storage of CO₂ is safe and there appears to be sufficient storage capacity in the United States for the volumes of CO₂ released by power generation and other applications. Further, CCS technology is evolving to further improve capture capability, lower energy consumption, and reduce costs. As pointed out in the NCC reports of 2004, 2006, and 2007, Research & Development programs, demonstration projects, and reasonable financial incentives should be implemented to spur commercial-scale demonstrations by 2015.

The United States Needs Additional Coal-Based Generation

The United States must come to grips with the reality that, like many of the countries discussed here, we are a growing nation with increasing electricity requirements:

- The population is growing by about three million people per year and will exceed 365 million by 2030 — an increase of 75 million in only three decades.
- The economy is expanding: The GDP will rise from \$11 trillion in 2006 to over \$20 trillion in 2030 — an 82 percent increase.
- Advances in electro-technologies will place substantial demands upon the electricity infrastructure as increased precision and reliability become even more crucial to productivity.

The implications of these demographic, economic and technological trends for America's electric supply system are reflected in EIA's projections of electricity demand through 2030:

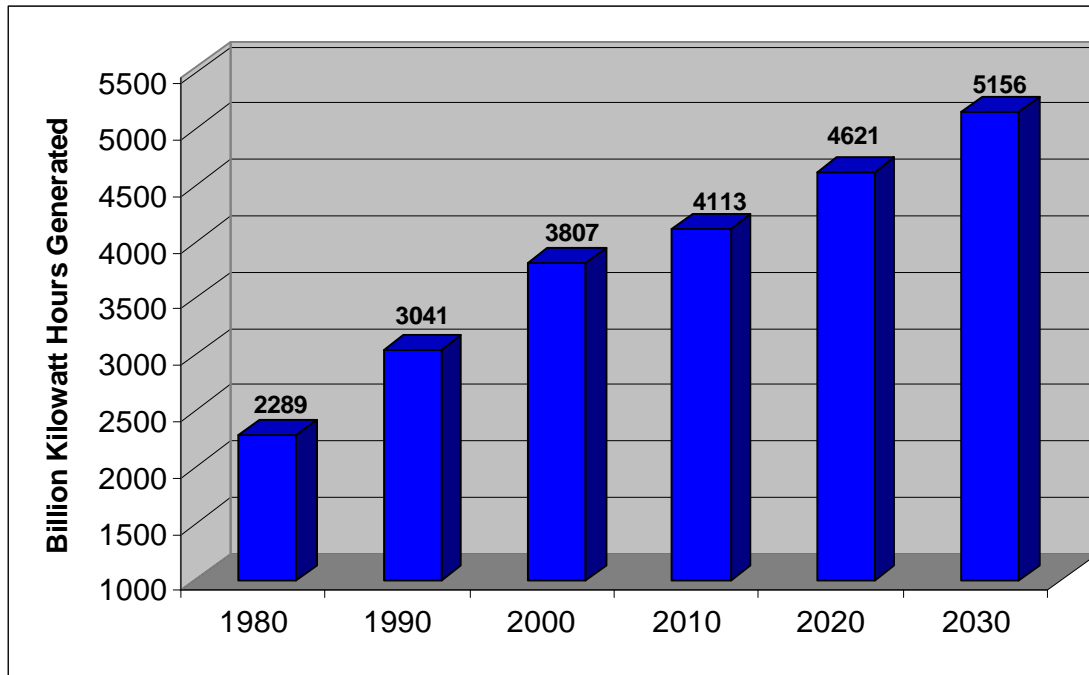

Source: EIA, 2008

Figure ES.2. The Rising Tide of Electricity Demand in the United States

The EIA has projected that at least 230,000 megawatts of new generation capacity will be needed by 2030 and that about 100,000 megawatts (43 percent) will be coal based.

Unfortunately, the National Electric Reliability Corporation (NERC) recently warned that the continuing short term focus on the construction of new natural gas-based generation has increasingly adverse implications for reliability:

“Long-term capacity margins are still inadequate... inadequate capacity margins [reflect] the industry’s relatively recent shorter-term approach ... short –term planning can’t preclude long-range strategies for modernization and expansion... dependence on short term natural gas generation... overlooks the need to integrate other necessary resources.”

Along these lines, the continuing forced cancellation of planned coal generation, coupled with the development of even more natural gas plants in such states as Texas, Florida, Kansas and Oklahoma, is setting the stage for reliability problems and higher electricity prices.

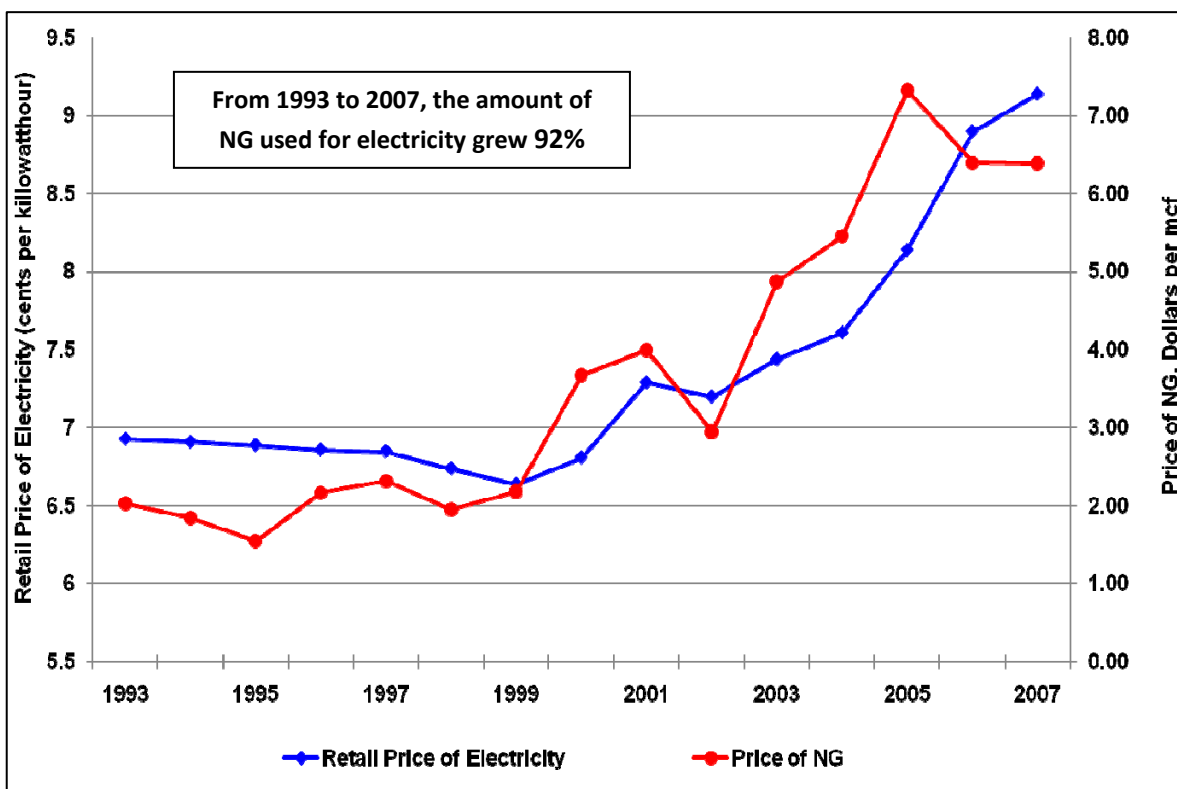

^{S1} **Figure ES.3. Using More NG to Produce Electric Power Increases the Price of Both NG and Electricity**

The EIA has projected that about 75 percent of new natural gas supply will come from LNG. If even more natural gas generation continues to be built to replace cancelled coal generation, the amount of LNG required in the next 20 years will be even greater than predicted. Hence, *de facto*, LNG would become the default fuel for generation and other uses. NERC has warned about such a situation:

“Importing LNG from abroad opens the U.S. fuel supply to the global market and all the economic and political risks associated with it” (NERC, 2007)

Thus, for the first time in history, the reliability of the U.S. electricity supply system would be dependent upon decisions made in other countries. Europe, of course, has already gone down that path, with all the attendant risks to energy security and economic stability. In order to meet the growing demand for electricity, additional coal-based generation is essential. Coal is the only major energy source which can meet projected electricity demand in a timely, reliable, affordable, and increasingly clean manner.

The scale required to replace new coal-based generation is beyond the scope of other fuels.

The EIA has projected that coal-based generation will increase by over 820 billion kilowatt hours (kWh) by 2030. This increase alone is as much as the combined current generation of France and Italy. Figure ES.4 demonstrates the magnitude of alternative fuels needed to (1) meet existing EIA projections for each fuel and (2) replace projected increases in coal generation:

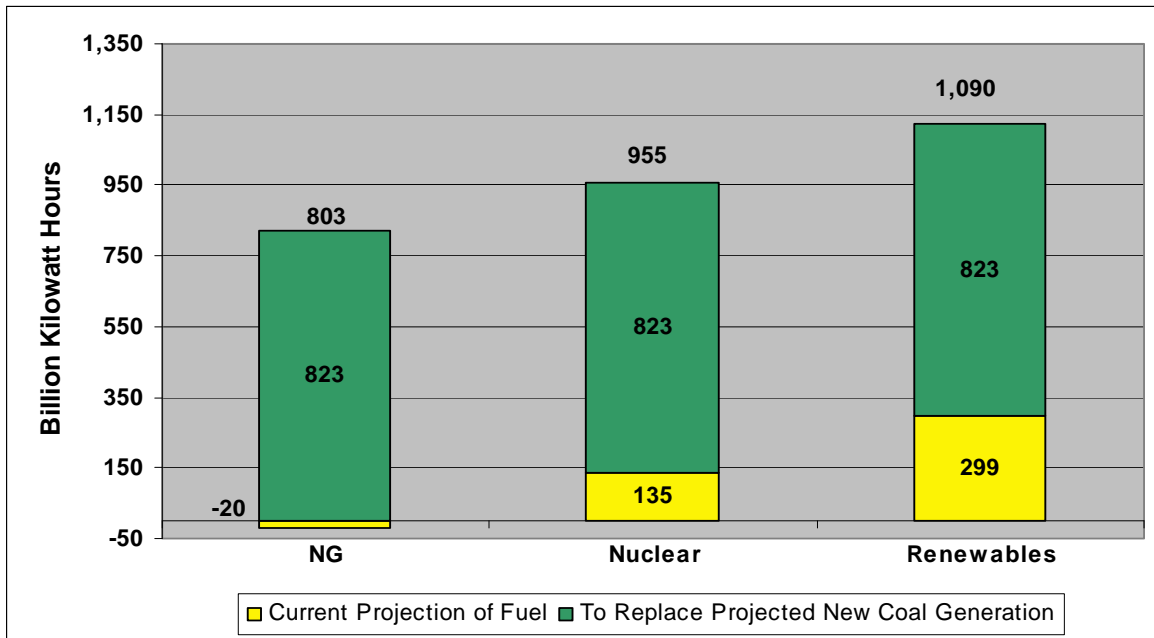

Source: Adapted from EIA data, 2008

Figure ES 4. The Scale of Alternative Generation Needed To Meet EIA Projections and Replace Projected Coal

The over 820 billion kWh needed to replace projected new coal generation, coupled with the expectations for the respective fuels would require the general equivalent of:

- 7 Trillion Cubic Feet (Tcf) of natural gas -- almost as much as the annual production of Texas plus Louisiana
- 110 nuclear plants -- we have 104 -- at a construction cost of \$385 billion
- 250 or more hydroelectric facilities the size of Hoover Dam

A series of logical steps to realize the full potential of coal

The series of National Coal Council reports over the past five years provides a systematic technological and regulatory pathway to cleanly and efficiently realize the full potential of our domestic coal resources.

A Multi-Step Process to Near-Zero Emissions

A Long-Term Approach to a Long-Term Challenge

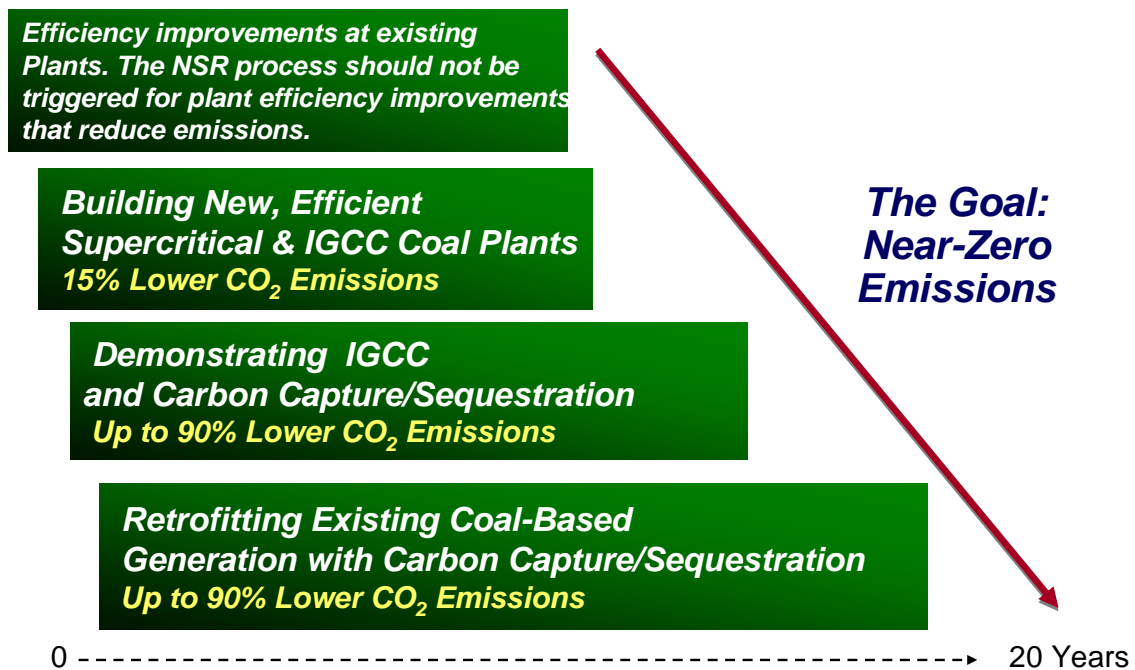

Figure ES.5. A Multi-Step Process to Near-Zero Emissions

FINDINGS AND RECOMMENDATIONS: The Realities of Energy

Chapter One presents an overview of the energy situation facing the United States. The succeeding chapters present a series of findings and recommendations, supported by technical analyses, which give the Secretary a detailed overview of how coal can be further utilized to meet the energy needs of the Nation.

Chapter Two: Carbon Management Technology Options

FINDINGS

1. Reducing CO₂ emissions from coal-based power plants is an enormous challenge. However, the electric power industry, technology producers, equipment manufacturers, academic and research organizations and the federal government are rapidly developing solutions that will secure coal's place as an important fuel source, even in a carbon constrained world.
2. Improvements in supply side efficiency must play an important role in both near and longer-term CO₂ emissions reductions.
3. Wholesale replacement of existing generating units cannot be accomplished in the near future. Besides daunting economic consideration, small subcritical units, with their high responsiveness to load demand fluctuation, contribute significantly to a robust portfolio of reliable generation technologies.
4. Advanced coal power plant technologies with integrated CCS will be crucial to lowering U.S. electric power sector CO₂ emissions. They will also be crucial to substantially lowering world CO₂ emissions if the technology is supported in rapidly growing Asia.
5. Research Development & Demonstration pathways have been identified to demonstrate a full portfolio of economically attractive, commercial-scale advanced coal power and integrated CCS technologies suitable for use with the broad range of U.S. coal types by 2025. Some technologies will be ready for some fuels sooner, but the economic benefits of competition will not be realized until the full portfolio is developed.

RECOMMENDATIONS

It is important to avoid prematurely choosing between clean coal technology options. Therefore, the Secretary should coordinate with other federal and state funding groups to support and help advance a full portfolio of technology options for the electric power industry.

1. The Department of Energy, the U.S. Environmental Protection Agency (EPA) and Congress must work together to remove the regulatory hurdles that impede the implementation of supply efficiency enhancements, including a more workable New Source Review.

2. The key to proving CCS capability is the demonstration of CCS at large-scale -- on the order of 1 million tons CO₂/year -- for both pre- and post-combustion capture with storage in a variety of geologies. Therefore, the Secretary should solicit from Congress funding for large combined capture and storage demonstrations to be conducted in different regions and with different coals and technologies.
3. The United States is a leading developer of clean coal technology. Since carbon management and climate change is a global issue, the Secretary should support efforts by international trade associations and Federal Agencies to enable the transfer of technology to countries such as India and China which are responsible for much of the growth in carbon emissions.

Chapter Three: Legal and Regulatory Dimensions of CCS

FINDINGS

1. If atmospheric CO₂ emissions are to be controlled, CCS is the only means available to address very large quantities of CO₂ emissions from coal-based facilities. However, it is a tool that requires significant additional research and the definition of a stable legal regime.
2. If carbon constraints are applied at the state or federal level, CCS may need to develop very quickly in order to maintain reliable and secure energy supplies. The legal regime applicable to CCS is very important, both to encourage its development and to speed the appropriately considered approval of needed projects.

RECOMMENDATIONS

The NCC recommends that the Secretary work with various parties, most particularly the states and other federal agencies, to promote a legal framework for CCS that will encourage rather than discourage its development. A legal framework to encourage development of CCS would include the following elements:

1. A single clear regulatory scheme administered by as few government agencies as possible, rather than multiple regulatory regimes with inconsistent or conflicting requirements.
2. Clear definition and assignment of risks under a single liability regime, rather than unclear, vague liabilities potentially posed under a variety of state and federal statutes.

Chapter Four: Plug-In Hybrid Electric Vehicles and Coal-Fueled Power Plants with CCS

FINDINGS

1. The combination of Plug-in Hybrid Electric Vehicles (PHEV) and coal-based electricity with CCS is an attractive way to use coal as a transportation fuel from economic, energy security and environmental perspectives. If the electricity were generated in coal-based power plants with CCS, total fuel greenhouse gas emissions per mile driven for a PHEV would be reduced by 60 percent, compared to a conventional vehicle (spark-ignition gasoline or diesel) or 37 percent compared to Hybrid Electric Vehicle (HEV). Even

without CCS, CO₂ emissions for the combination of a PHEV and coal-fueled electricity generated in a state-of-the art power plant are about equivalent to those of an HEV, and less than for a conventional vehicle.

2. A PHEV charged with coal-based electricity displaces petroleum (two-thirds of which now is imported with domestic coal as a transportation fuel). Replacing 60 percent of the light- and medium-duty vehicle miles with PHEV miles by 2050 would reduce petroleum consumption by 3.7 million barrels per day.
3. PHEVs are not commercially available at present. General Motors announced its “Volt” PHEV concept car with a “market introduction date” of 2010, and Toyota, Chrysler, Nissan, and Ford also have PHEVs under development. EPRI expects PHEVs to enter the commercial marketplace in 2010. The principal technical issue is the cost and performance of the PHEV battery, which is the subject of considerable federal and private R&D.
4. A major impediment to the commercial acceptance of the PHEV will be its initial purchase price, projected to be \$2,000-3,000 above the HEV price when introduced into the commercial market, principally because of the battery cost. This is offset to some extent by lower fuel costs, but the payback period might be 10 years or longer, depending on fuel, electricity and vehicle purchase prices.
5. During its initial introduction, the electricity requirements for the fleet of PHEVs would be low and could be met by the existing generating capacity, in part because PHEVs would be charged most frequently at night when excess capacity is available. To put this in context, a single 600 megawatts power plant would generate enough electricity to supply two million PHEV40s. Various studies conclude that even with significant PHEV penetration, the incremental electricity demand is modest. For example, EPRI found from its modeling that replacing 60 percent of the total light- and medium-duty vehicle fleet by 2050 would result in only a 7.8 percent increase in electricity demand.
6. Since its introduction in 1999 through 2006 about 650,000 HEVs were sold in the United States, and a similar pace of introduction of PHEVs would suggest that they would not create substantial electricity demand for a decade. The timeframes for the deployment of PHEVs in sufficient number to create the demand for new coal-based power plants, and the deployment of CCS-equipped coal plants are relatively consistent within the 2020-2030 period. Because of the technical and economic difficulties in reducing CO₂ emissions from the transportation fleet, incentives for broad scale PHEV adoption can be highly cost-effective, on the order of \$3-5/ton on an avoided-CO₂ cost basis.

RECOMMENDATIONS

1. The Secretary should support research and development on coal-based electricity generating technologies, including CCS, to ensure adequate supplies of electricity to support the broad commercial implementation of PHEVs or other electric vehicles.
2. The Secretary should support research to reduce the cost and improve the performance of PHEVs, with particular emphasis on the cost, performance, durability, safety and environmental impact of batteries.
3. The Secretary, working with other agencies and Congress as appropriate, should promote incentives for the deployment of advanced coal-based electricity generating technologies coordinated with the substantial market penetration of PHEVs or other electric vehicles,

recognizing the economic, energy security and environmental benefits of electrification of the transportation fleet.

Chapter Five: Liquids from Coal

FINDINGS

1. The Safe, Accountable, Flexible, Efficient, Transportation Equity Act: A Legacy for Users (SAFETEA-LU) 2005 extension, provides a 50 cent per gallon excise tax credit for certain alternative liquid fuels, including CTL products. This incentive is scheduled to expire in 2009, before any major new CTL plants can be built. Its extension through 2020 will provide critically needed market incentives for CTL development. CTL plants, especially the first ones to be built, often face difficulty in raising the required private capital investment.
2. Robust research programs undertaken in earlier years to improve the chemistry of SNG production and the preparation of new products in downstream processes have been inhibited by the lack of federal programs to support research in coal chemistry. The nation has experienced a sharp decline in the number of researchers in this area as a result of the elimination of industrial coal research labs and the elimination of federal research support. Investments in research would bring about improved yields and products from coal-SNG processes.
3. A clearly defined permitting process for CTL facilities will reduce the uncertainty, time, and cost required for permitting, while retaining regulatory process and oversight. In order to facilitate the rapid scale-up of CTL production capabilities in the United States, regulatory changes are necessary, and standardizing, simplifying, and expediting the permitting process is crucial. The “not in my back yard” mentality, often accompanied by costly time-consuming litigation and obstructionism, needs to be countered with legislation and leadership.
4. Total oil consumption by U.S. military forces is approximately 300,000 bpd, and through the development of BUFF specifications a substantial portion of this requirement can be met with domestically produced CTL fuels. The Department of Defense (DOD) desires to enter into long-term contracts for the purchase of alternative fuels made in the U.S. from domestic resources. This is part of DOD’s Total Energy Development (TED) Program, the stated mission of which is to “catalyze industry development and investment in alternative energy resources.” DOD fuels purchased under long-term contract can help establish a foundation on which to build a CTL industry and can secure the high quality American-made CTL fuels desired by DOD.

RECOMMENDATIONS

1. Congress should extend the 50 cent per gallon alternative liquid fuels excise tax credit. Also, the federal government should provide assistance to industry to attracting private capital for new facilities by:

- Providing for 100 percent expensing in the year of outlay for any CTL plant that begins commercial operation by 2020
 - Providing for a federal loan facility of \$100 billion with the ability to provide loan guarantees for the initial commercial scale CTL plants (see EPA Act 2005, Title XVII)
 - Extending the CTL excise tax exemption to 2020 (Safe, Accountable, Flexible, Efficient Transportation Equity Act: A Legacy for Users SAFETEA-LU 2005 extension)
 - Extending the temporary expensing for equipment used in refining to 100 percent of any required additions to existing refineries needed to handle CTL products (EPAAct2005, § 1323)
2. The federal government should increase its support of SNG chemistry, and research should be directed toward improved conversion processes for CTL and CBTL in bench and pilot studies of catalysis, processes to minimize CO₂ production, and of different coal types. Research should also focus on the development of alternative products from SNG chemistry, such as SNG, chemicals, and carbon products, the use computational chemistry to model catalysts, and assessment of the economics of emerging research.
 3. The federal government should develop clearly-defined permitting processes for siting, constructing and operating CTL plants. Federal agencies should work with local, state, and tribal agencies to establish a well-defined permitting process for the siting, construction, and operations of CTL plants. This should include all environmental impact documentation and permits related to air, water, land, product transport, mining, community impact, and safety and health. The federal and state governments should provide regulatory streamlining for the production of CTL fuels and should:
 - Standardize, simplify and expedite permitting and siting with joint federal, state, and local processes, policies, and initiatives.
 - Make appropriate federal, state, and local government sites available for CTL plants, including Base Realignment and Closure (BRAC) military sites and disused heavy industry sites for which industries have foundered and the sites are now abandoned but could be reinstated as CTL sites.
 - Encourage local leadership to modify approaches to zoning and other land use and business regulations to accommodate CTL activities.
 4. The federal government should authorize and fund military purchases of CTL fuels under long-term contract. Congress should support DOD's TED program, including extending its long-term contracting capabilities from five years to as long as 25 years. Appropriations and necessary authorizations and funding for these programs should be given high priority.

Chapter Six: Underground Coal Gasification

FINDINGS

1. Underground coal gasification (UCG) converts coal in-situ into a gaseous product, commonly known as synthesis gas or SNG through the same chemical reactions that occur in surface gasifiers.

2. Gasification converts hydrocarbons into a SNG at elevated pressures and temperatures, and can be used to create many products including electric power, chemical feedstock, liquid fuels, hydrogen, synthetic gas.
3. Gasification provides numerous opportunities for pollution control, especially with respect to emissions of sulfur, nitrous oxides and mercury.
4. UCG could significantly increase the coal resource available for utilization by gasifying otherwise unmineable deep or thin coals under many different geological settings. A 300 to 400 percent increase in recoverable coal reserves in the United States is possible.
5. For developing countries undergoing rapid economic expansion, including India and China, UCG also may be a particularly compelling technology.

RECOMMENDATIONS

1. Renewed research program – The United States disbanded its research program in 1989. Since then, no government agency has sponsored scientific research into UCG processes or products. A number of outstanding technical issues, including costs and economics, process engineering, subsurface process monitoring and control, risks and hazards, and synergies with carbon management remain unexplored. Improved simulations are also needed for gasification, formation of the cavity, the flow and transport of contaminants and subsidence in order to better define the boundary conditions for practice and to decrease the learning curve. A substantial research program is recommended that includes participation of research institutions, universities, and companies.
2. Given the relatively minimal experience in the United States with UCG, a serious, detailed engineering analysis of each step in the entire process should be undertaken along with a thorough economic analysis that includes but is not limited to estimates of the cost at various stages of development and operation and a comparison of UCG with other technologies used to generate electricity.
3. Since UCG has the ability to use what has historically been considered to be unmineable coal, thereby increasing the overall potential coal supply in the United States, further study should be undertaken to quantify the amount of unmineable coal and its ability to contribute to the energy needs of this country. A partnership between the USDOE and US Department of the Interior through the assistance of the US Geological Survey would be useful.
4. Engage with field demonstration – The two existing and rapidly emerging field programs in the United States, China, and North America provide near-term opportunities for investigating key technical and non technical concerns. These are platforms to test subsurface monitoring equipment, validate simulators and models, and understand potential environmental concerns. Some projects might be pursued through the Asia Pacific Partnership given the needs in developing countries around pollution abatement and clean coal technology development. Others could be pursued through public-private partnerships. The DOE should assess these pilots and investigate their current status and goals in considering which ones provide the best opportunities to meet key goals. Additional funds beyond a core R&D program should be brought forward for field testing, monitoring, and validation.
5. Develop standards – At present, there are no broadly accepted standards for siting and operation of UCG projects and facilities. To help commercialization in North America,

we recommend a three to five year research program aimed at providing key industries, regulators, and decision makers with the technical basis needed to screen out problem sites and encourage sound investment.

6. Understanding UCG and CCS – In-situ gasification has the potential to dramatically reduce the costs of SNG production and thereby CCS. However, these two enterprises are fundamentally distinct and have their own technical, commercial, and environmental needs. We recommend a formal program to investigate how UCG might enable or hinder CCS development and deployment and to identify potential synergies that will enhance economics and site performance.
7. Develop materials for outreach and education on UCG – Few decision makers in the United States are familiar with UCG as an energy technology option. The DOE should engage its own expertise and knowledge to develop briefing materials and public outreach documents that could be used to engage stakeholders.

Chapter Seven: Turning Coal into Pipeline Quality Natural Gas

FINDINGS

1. Growing United States demand for natural gas is forecast to continue to exceed our capacity to produce natural gas domestically. This presents an energy security problem, as the broadly proposed alternative is imports of LNG from countries that may be politically unstable.
2. The production of natural gas from abundant, domestically produced coal provides a clean, competitive and secure alternative.
3. Technologies exist to convert coal into 4 trillion cubic feet of natural gas annually by 2025.

RECOMMENDATIONS

1. The U.S. must take steps now to remove the key barriers to implementation of projects to produce natural gas from coal, namely: environmental permit approval, financing risk, and carbon sequestration solutions.
2. Some incentives should be made available to the first group of projects to overcome the increasing capital costs. These incentives should include investment tax credits and Federal loan guarantees.
3. Additional funding should be utilized to accelerate demonstration of carbon sequestration.

Chapter One

The Realities of Energy

Over the past five years, the NCC has submitted four reports to the U.S. Department of Energy delineating emerging issues in energy supply and explaining how coal can be used to cleanly generate additional electricity and also be converted into liquid fuel and SNG (SNG). Taken together, these four reports, completed in 2004, 2006, 2007 and 2008, provide a technical, environmental, regulatory, and socio-economic framework for broader utilization of America's greatest energy resource--coal.

Also over the past five years, coal has maintained its status as America's tireless energy workhorse by producing 50 percent of our electricity at only one fourth the price of natural gas . Thanks to coal, the United States has the most reliable electric power supply system in the world.

Other nations have seen the benefits coal brings to the United States, and there are now over 660,000 megawatts of new coal generation either under construction or planned around the world. In addition, countries such as China and India are rapidly moving to use their own coal resources to produce electricity, in addition to liquid fuels, SNG and chemicals. Using domestic coal for a broader range of applications will enable China and India to reap substantial internal economic benefits by significantly reducing imports of oil and natural gas. This point was stressed in the Council's 2006 report regarding the opportunity for the U.S. to use American coal to bring significant benefits to consumers, generate high-quality employment, and improve energy security.

The Power of Coal Conversion:

Electricity	Liquids	SNG	Economic Growth
<p>100 GW</p> <p>Almost 60 percent of projected capacity</p>	<p>2.6 million b/d</p> <p>Half of current U.S. production</p>	<p>4 Tcf/y</p> <p>A new Gulf of Mexico plus Louisiana</p>	<p>1.4 million new jobs</p> <p>53 trillion in GDP gains</p>
375 tons	475 tons	340 tons	1,200 tons

Coal conversion: Stabilize Prices—Reduce Dependence —Reinvigorate the Industrial Base

Finally, over the five years the NCC has submitted reports, a series of untoward, though not entirely unexpected, events have changed the energy landscape, and we gaze at an unfamiliar horizon:

- Oil prices have more than doubled.
- LNG prices are approaching parity with oil prices and competition for supply from Europe and Asia has substantially reduced cargoes available to the United States.
- World oil production has stagnated as production in the leading non-OPEC producers of the United States, Mexico, China, and Norway (and perhaps Russia) has peaked. OPEC production is difficult to verify but, based on EIA data, the cartel produced 31.8 million barrels of crude oil per day in 2005, 31.3 million in 2006, and 30.9 million in 2007.
- Ethanol production from corn has come under bitter criticism not only for the energy balance issue, but also for the impact increased production has on the world's food supply.
- Higher prices for natural gas are being driven by demand from power generators. Families and businesses are now caught up in competition with power plants for natural gas. Since 2000, both the residential and industrial price of natural gas has increased about 70 percent. The impact is far reaching:
 - a. Industrial Energy Consumers of America stated in December, 2007: "Higher natural gas prices directly impact manufacturing competitiveness and have been a significant contributor to the loss of 18 percent of all manufacturing jobs since 2000."
 - b. Families have been impacted as they face not only higher natural gas bills and escalating electric rates. Lower income levels, particularly minorities and female heads of households have been disproportionately impacted, and Low-Income Housing Energy Assistance Programs (LIHEAP) in some states have been overwhelmed with literally hundreds of thousands of new applicants seeking relief from increasing energy bills.

This list could be greatly extended but these examples prove the point. The world in general, and the United States in particular, has entered a new energy era, one marked by questionable supply, escalating demand, higher prices, increased competition, and confusion as to the correct path.

This confusion can be at least partially traced to a steady stream of "optimistic" energy predictions regarding price and supply. As recently as 2004, for instance, leading agencies had rosy views of natural gas prices in 2008:

- EIA projected wellhead prices would be below \$4.00 per mcf in 2008
- California Energy Commission projected wellhead prices would not exceed \$3.50
- National Energy Board of Canada projected Henry Hub prices of \$ 7.00

Once again, these are just examples of a trend, but demonstrate the tendency for energy analysts to assume the best over the past decade and they continue to do so today. There can be little

question regular reassurances that “prices will go down” or “supply will increase” have constrained our recognition of the realities discussed here.

TEN ENERGY REALITIES FACING THE UNITED STATES

Fortunately, as we embark on this new energy era, the United States is blessed with vast natural resources, the strength of free enterprise, and an advanced technological base. Nevertheless, it greatly behooves Americans to step back and consider the stark energy realities that will impact the current generation as well as succeeding ones.

1. Coal is America’s Greatest Energy Resource

Coal has supplied the energy to build America for almost two hundred years. From the steam engine to the steel furnace to electric power plants, coal has been front and center as the energy source for progress. The magnitude of coal’s contribution is readily apparent in the role it plays in the nation’s electric power supply system.

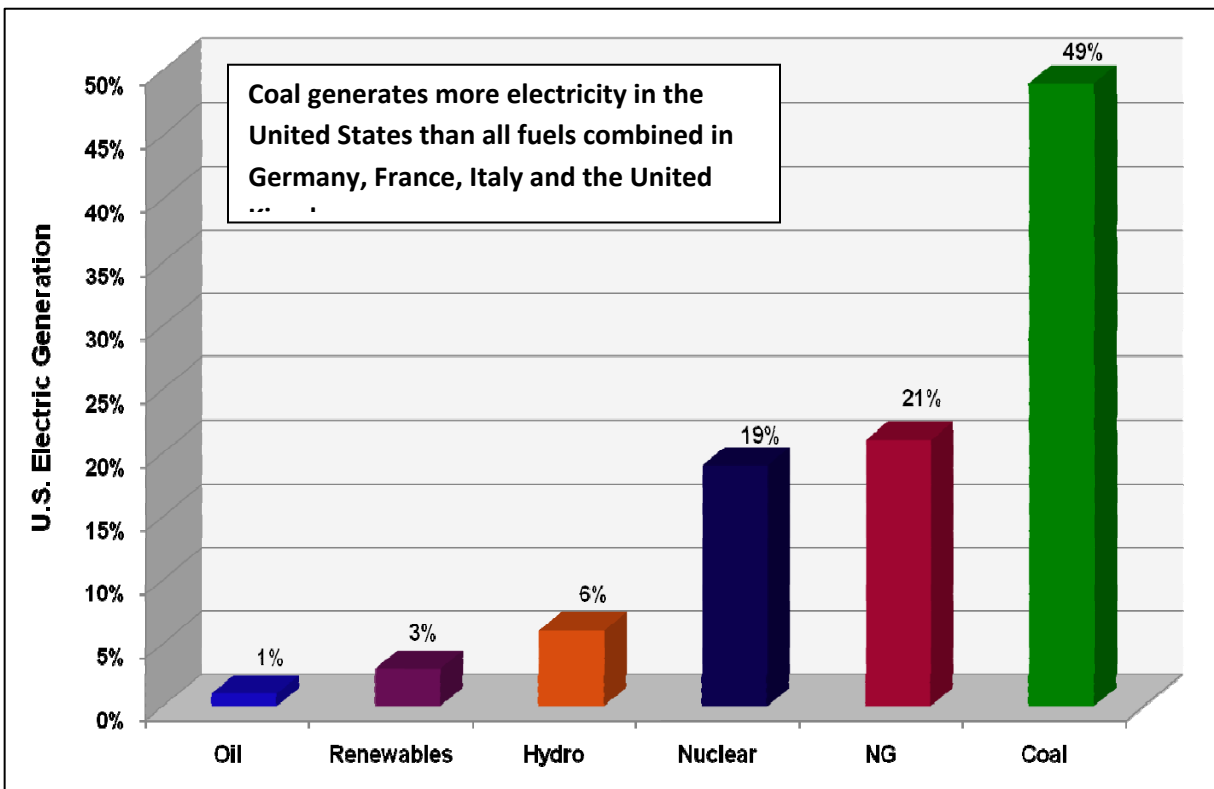

Source: Adapted from EIA data. 2008

Figure 1.1. Coal is the Cornerstone

And this resource is America’s ace in the hole. The United States has a demonstrated reserve base of almost 500 billion tons of coal distributed across more than 25 states. The reserves of other energy producers pale when compared to the vastness of American coal:

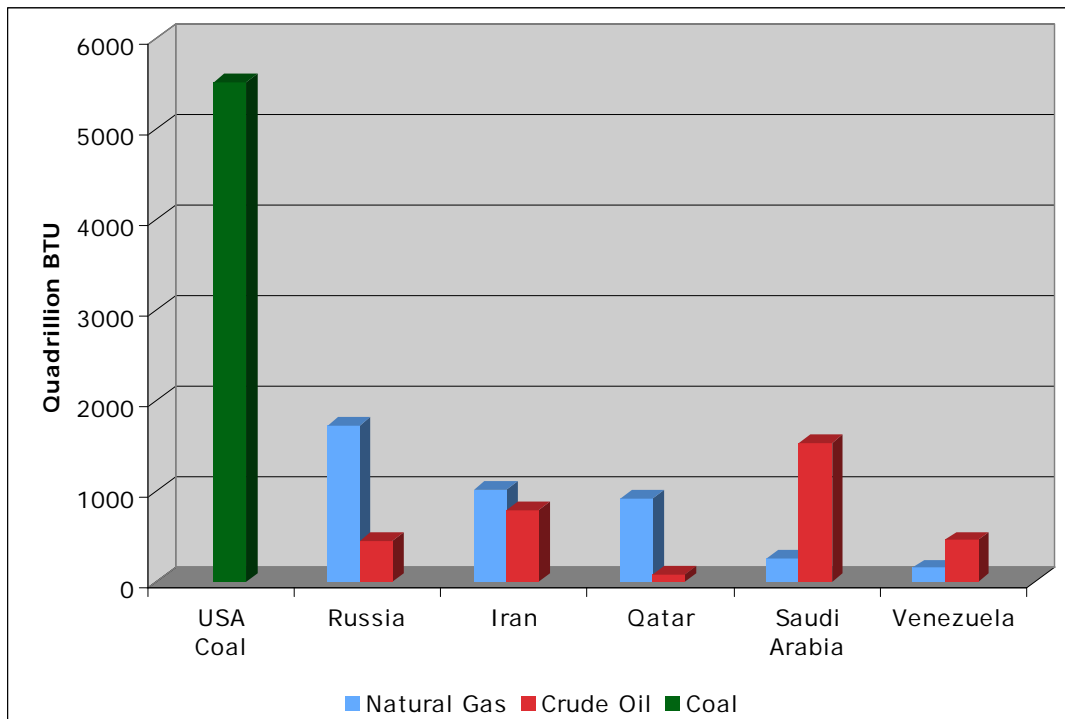

Source: Adapted from EIA data, 2008

Figure 1.2. American Coal in Perspective

2. Clean Coal Technologies Work, But Take Time to Develop

Technology has a successful track record of reducing criteria emissions from coal power plants. For the past several decades, continuous technological advances have steadily reduced criteria emissions while enabling the greater use of coal to generate electricity. Advanced pollution control technologies now mean more than 90 percent reduction of emissions of criteria air pollutants from new coal-fired power plants.

Further, and even more important, as the Council’s series of reports demonstrates, technology has the wherewithal to unlock even more of coal’s potential contribution from additional electricity to cleaner liquid fuels to pipeline-quality SNG to hydrogen to electric vehicles to petrochemicals.

Carbon Capture and Storage (CCS) technology is the real game changer for coal. CCS consists of technology to capture carbon dioxide (CO₂) from a fossil fuel utilization facility, compress the gaseous CO₂ into a dense fluid form, transport the CO₂ to a suitable storage site, and inject the CO₂ into a porous geological formation where it will permanently remain. Captured CO₂ can also be used as an injection fluid to recover crude oil from depleted oil reservoirs.

CCS is a technically viable solution for controlling CO₂ emissions from coal-based power generation, coal-to-liquid production, and the production of SNG.

At the present time, while there are no CCS applications at power plants, carbon capture is being implemented in oil and NG production, refining and industrial applications. Sequestration has been used successfully for enhanced oil recovery for the past 30 years.

Long-term, geologic storage of CO₂ is safe, and there is sufficient storage capacity in the United States for the volumes of CO₂ released by power generation and other applications. Further, CCS technology is evolving to further improve capture capability, lower energy consumption, and reduce costs. As noted in the NCC reports of 2004, 2006, and 2007, Research and Development (R&D) programs, demonstration projects and reasonable financial incentives should rapidly be implemented to spur commercial-scale demonstrations by 2015.

3. The United States is a Growing Nation

The U.S. birth rate in 2007 was the highest in over 35 years. The population is growing by three million people a year and by 2030 will reach 365 million. The United States is the third most populated country in the world. Further, this population growth is coupled with economic expansion. The growing Gross Domestic Product demonstrates the strength of the American economy:

Year	Gross Domestic Production Billion in 2000 \$
2005	11,004
2010	12,453
2020	15,984
2030	20,219

Source · EIA 2008

Table 1.1. The Growth of the GDP of the United States

This demographic and economic growth has had a clear impact upon energy consumption as total energy use in the United States has increased by almost 15 billion quadrillion Btu (quads) in the last 15 years. Nowhere is this increased consumption more prevalent than in the household use of electricity:

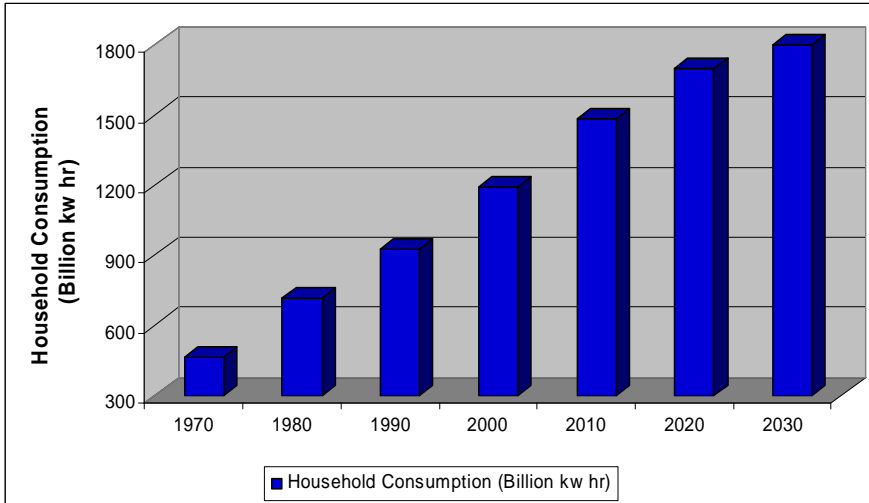

Source: EIA, 2008

Figure 1.3. U.S. Household Consumption of Electricity

4. Oil and NG Production Have Likely Peaked in the United States

In 1972, the United States produced 3.36 million barrels of oil. That production level has dropped steadily over the past three decades and in, 2007, the United States only produced 1.86 million barrels or 54 percent of 1972 production (EIA, 2008).

Natural gas production has been somewhat more resilient but also has been the victim of higher decline rates, smaller wells, and less productivity per well.

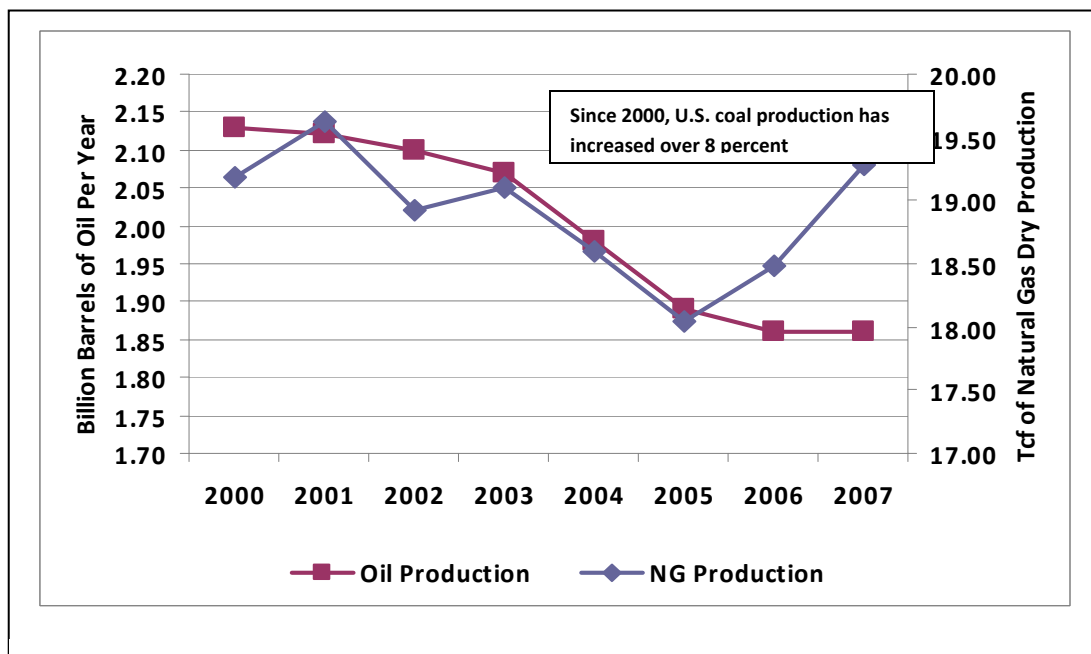

Source: EIA, 2008

Figure 1.4. Oil and NG Production in the U.S. Since 2000

5. The United States Needs New Coal-Based Generation

Over the past decade, more than 90 percent of new power plants were natural gas based. As these generation units were integrated into the electric grid they: (1) consumed natural gas and (2) competed with households, businesses, and industrial facilities for fuel. Since projected natural gas supply growth did not materialize, both the price of natural gas and the price of electricity have steady increased.

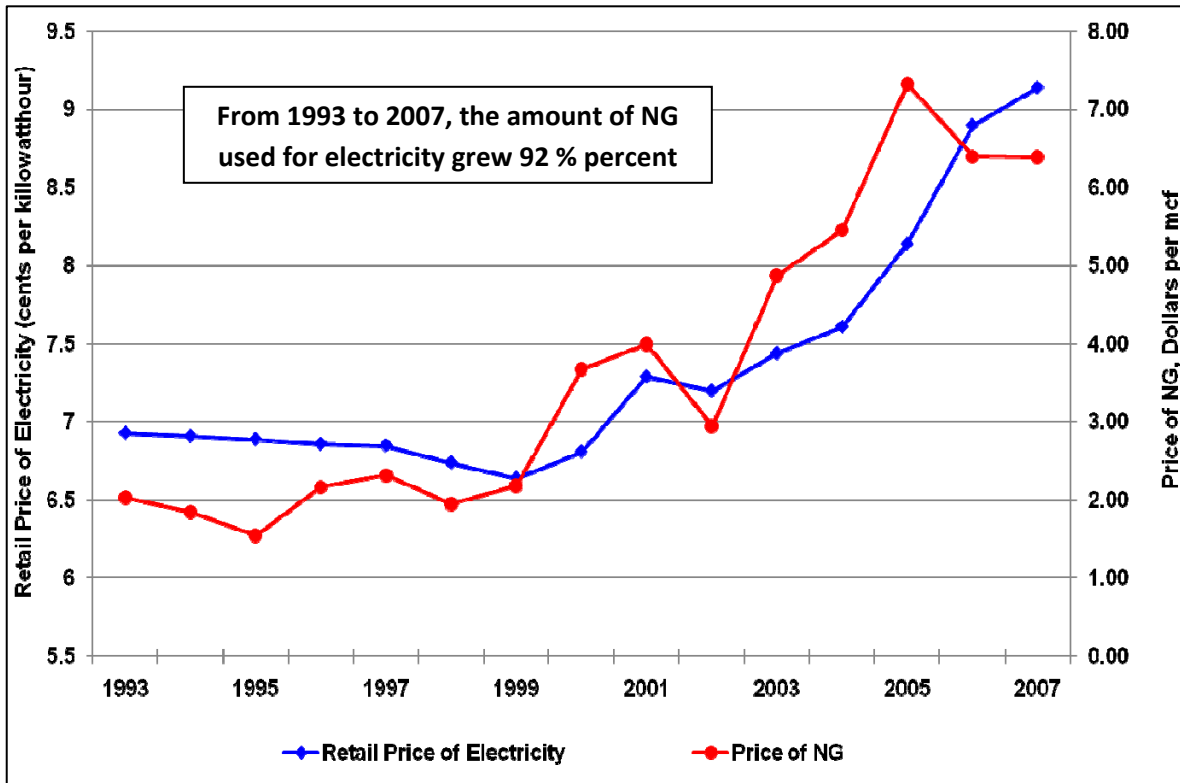

Source: Adapted from EIA data, 2008

Figure 1.5. Using More NG to Produce Electric Power

Families and businesses are now caught up in competition with power plants for natural gas. This situation is being exacerbated as a number of utilities are being forced to cancel planned coal facilities and are turning to even more natural gas generation as the path of least resistance.

In order to meet the growing demand for electricity, additional coal-based generation is essential. The EIA has projected that coal-based generation will increase by over 820 billion kWh by 2030. This increase alone is as much as the combined current generation of France and Italy.

The scale required to replace new coal based generation is beyond the scope of other fuels.

The magnitude of alternative fuels which would be needed to (1) meet existing EIA projections for each respective fuel and (2) replace projected increases in coal is substantial:

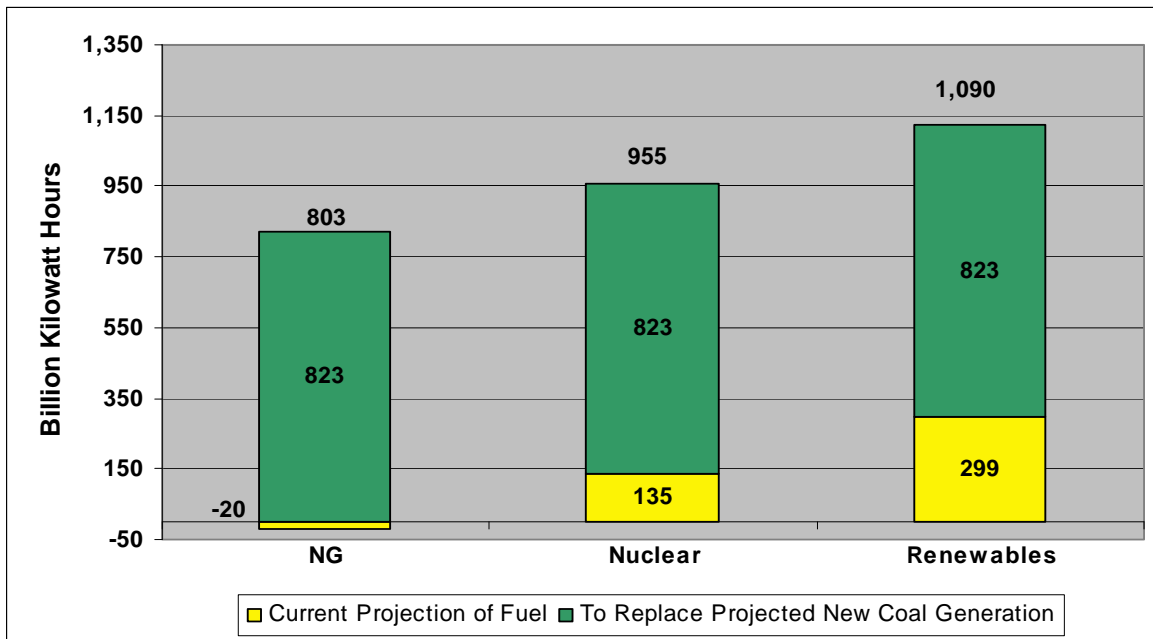

Source: Adapted from EIA data, 2008

**Figure 1.6. The Scale of Alternative Generation Needed To:
(1) meet EIA projections for each fuel and (2) Replace projected coal**

The generation increases in Figure 1.6 would require:

- 7 Trillion Cubic feet (Tcf) of natural gas—almost as much as the annual production of Texas plus Louisiana
- 110 Nuclear plants (we have 104) at a construction cost of \$385 billion.
- 250 hydroelectric facilities the size of Hoover Dam

(A) **The difficulties of obtaining 7 additional Tcf of NG/LNG.** The EIA has projected that about 75 percent of new natural gas supply will come from LNG. If even more planned coal-based generation is cancelled, however, the amount of LNG required in the next 20 years will be even greater than predicted. Hence, *de facto*, LNG would become the default fuel for generation and other uses. Both Federal Energy Regulatory Commission (FERC) and North American Electric Reliability Cooperation (NERC) have warned about such a situation:

“North American gas production is inadequate to meet demand. We are in competition with other importing regions of the world for LNG supplies. And we are not predestined to prevail in that competition.” (Joseph Kelliher, Chair of FERC, 2007)

“Importing LNG from abroad opens the United States fuel supply to the global market and all the economic and political risks associated with it” (NERC, 2007)

Thus, for the first time in history, the reliability of the U.S. electricity supply system would be dependent upon decisions made in other countries. Europe, of course, has already gone down that path, with all the attendant risks to energy security and economic stability, leading Paolo Scaroni, Chief Executive Officer (CEO) of Eni S.p.A. to warn: **“Europe is sleepwalking into staggering dependence on natural gas.”**

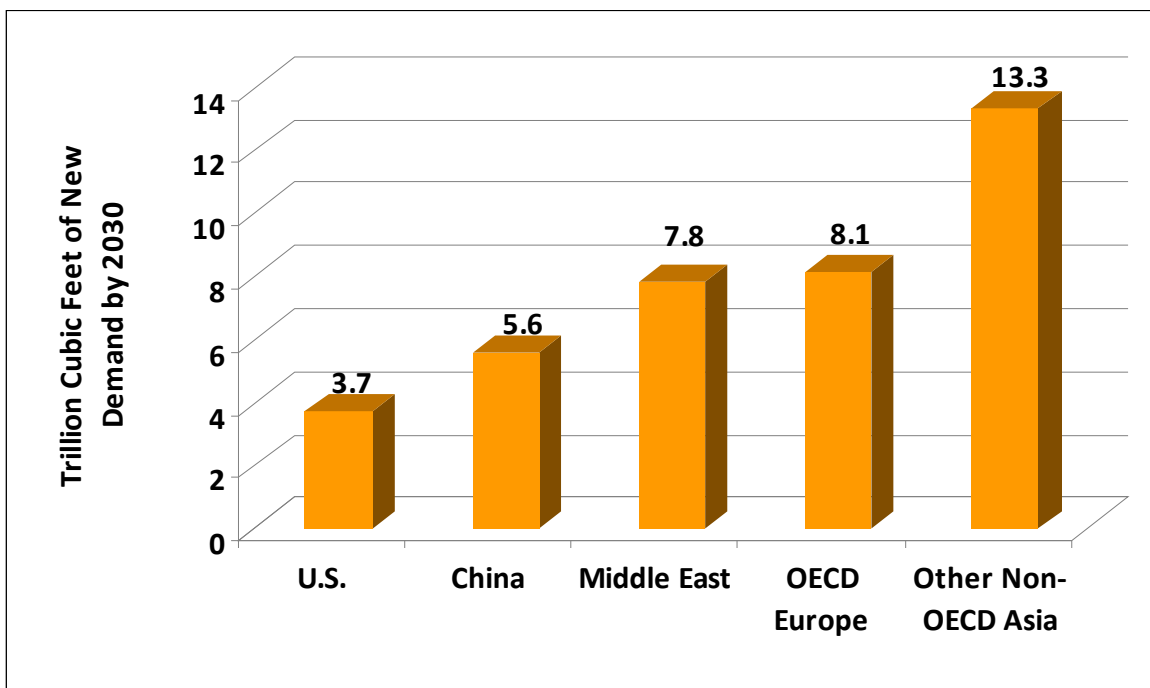

Note: Europe is building or has planned at least 150 GW of NG-based generation

Figure 1.7. Competition for NG/LNG Supply Will be Intense

(B) The difficulties of building over 100 nuclear plants. Nuclear power is an essential part of our electric power supply system and more nuclear generation would benefit reliability. The scale of nuclear needed to replace projected new coal generation, however, is far beyond any reasonable expectations. Indeed, no major reference case forecast suggests major nuclear capacity additions in the United States through 2030:

- EIA Projects 17 new gigawatts (7 percent of total new GW)
- IEA projects a 15 percent increase in nuclear generation

- IAEA projects an 18 percent increase in nuclear generation

These forecasts aside, it is highly unlikely 100 or more GW of new nuclear power stations could even physically be built within two decades. Several important factors will work to impede widespread expansion of nuclear power, including (a) continuing delays in the Yucca Mountain disposal site, (b) entrenched opposition to nuclear from literally hundreds of national and local groups, (c) global competition for fuel, expertise and nuclear grade materials and components. Finally, cost is a clear issue. Recent estimates for new nuclear plants are in the range of \$ 3,500 per KW, leading to a typical plant cost of over \$3.5 billion.

In essence, a major amount of new generation from all available sources is needed. In order to meet the growing demand for electricity within the confines of national security, however, additional coal-based generation is essential. Coal is the only major energy source that can meet projected electricity demand in a timely, reliable, affordable, and increasingly clean manner.

6. Global Supply of Oil and NG is Questionable

The growing dependence of the United States means loss of control over energy supply. Production issues, politics and competition from other nations pose real difficulties for the United States. Two examples will suffice:

- (1) Crude oil production has not kept pace with demand despite a significant increase in drilling activities.

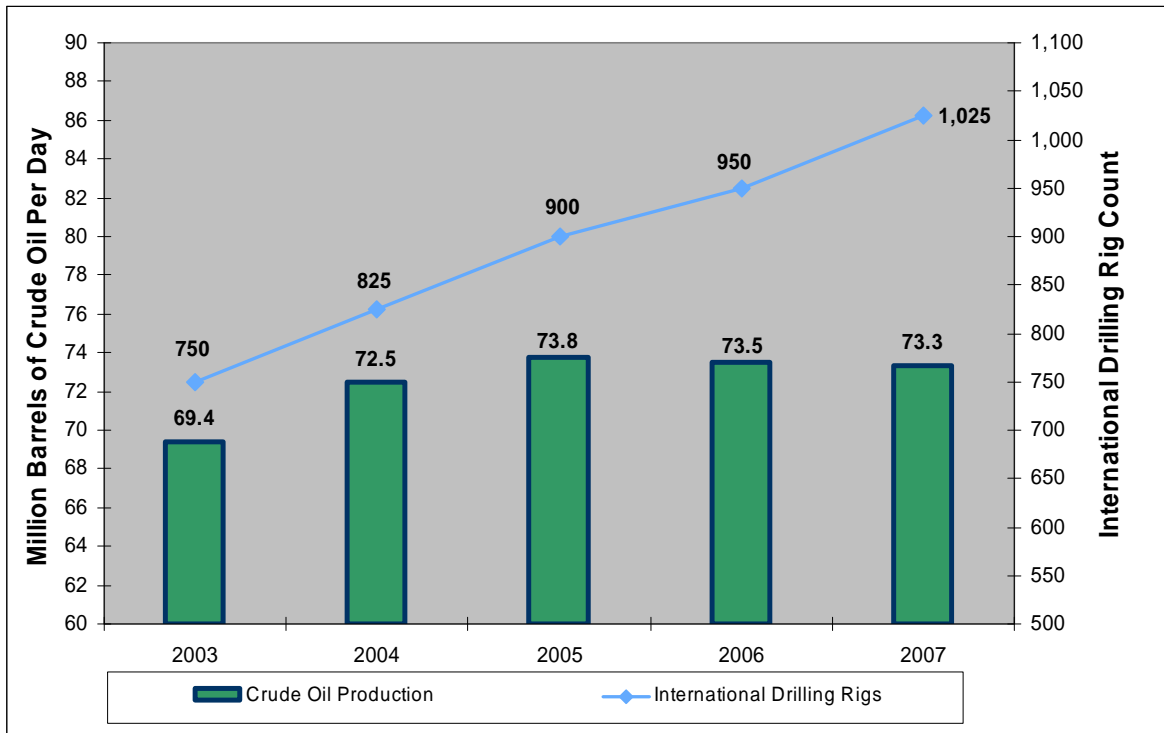

Source: EIA, 2008; Baker Hughes Inc, 2008

Figure 1. 8. World Crude Oil Production Versus Number of International Rotary Drilling Rigs, 2003-2007

(2) **LNG imports** have long been seen as the answer to faltering North American natural gas production. As recently as 2005, for example, a leading executive of Total Oil concluded: “The Atlantic liquefied natural gas market faces the risk of oversupply.” Higher liquefaction and transportation costs, project cancellation and deferrals, and competition from Europe and Asia have caused EIA to significantly reduce its projection for LNG imports in 2015.

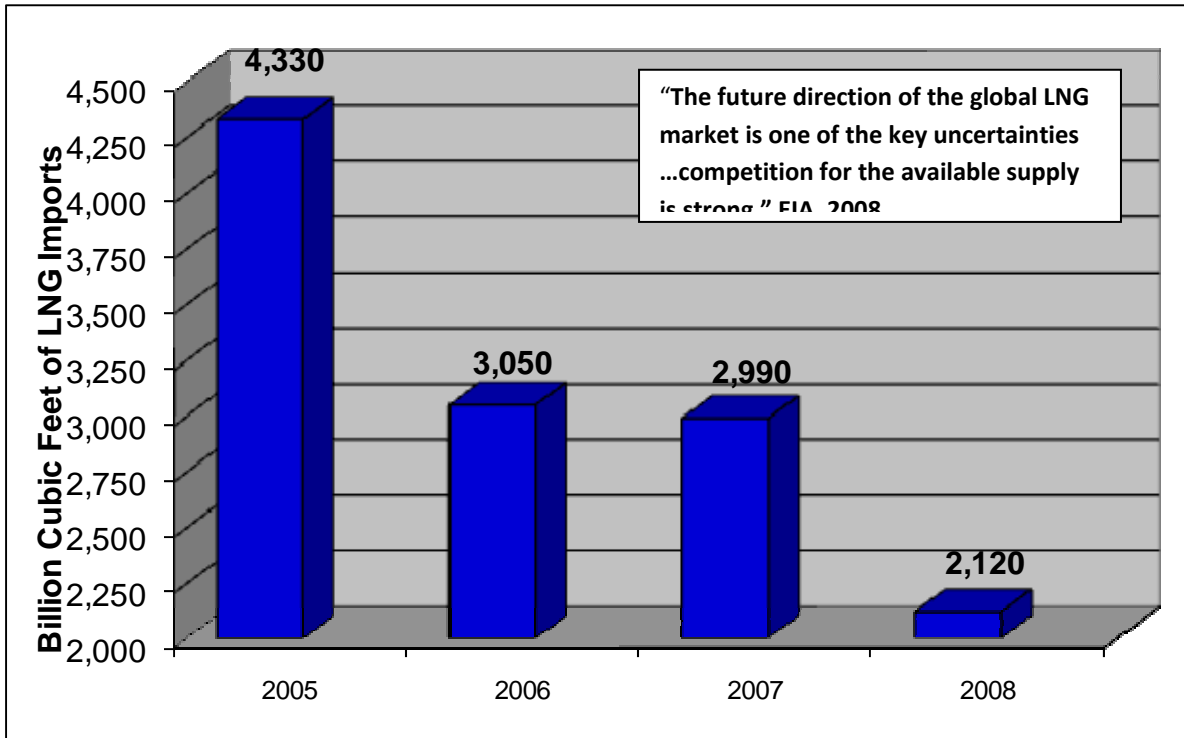

Source: Annual Energy Outlooks 2005-2008

Figure 1.9. Declining Expectations for LNG Imports in 2015

7. Global Demand for Energy is Growing at an Unprecedented Rate.

The EIA projects that world primary consumption of energy will increase from 463 quads in 2005 to 702 quads in 2030 — an increase of 52 percent. This increase of 239 quads is more than the current consumption of Europe, North America and Russia combined.

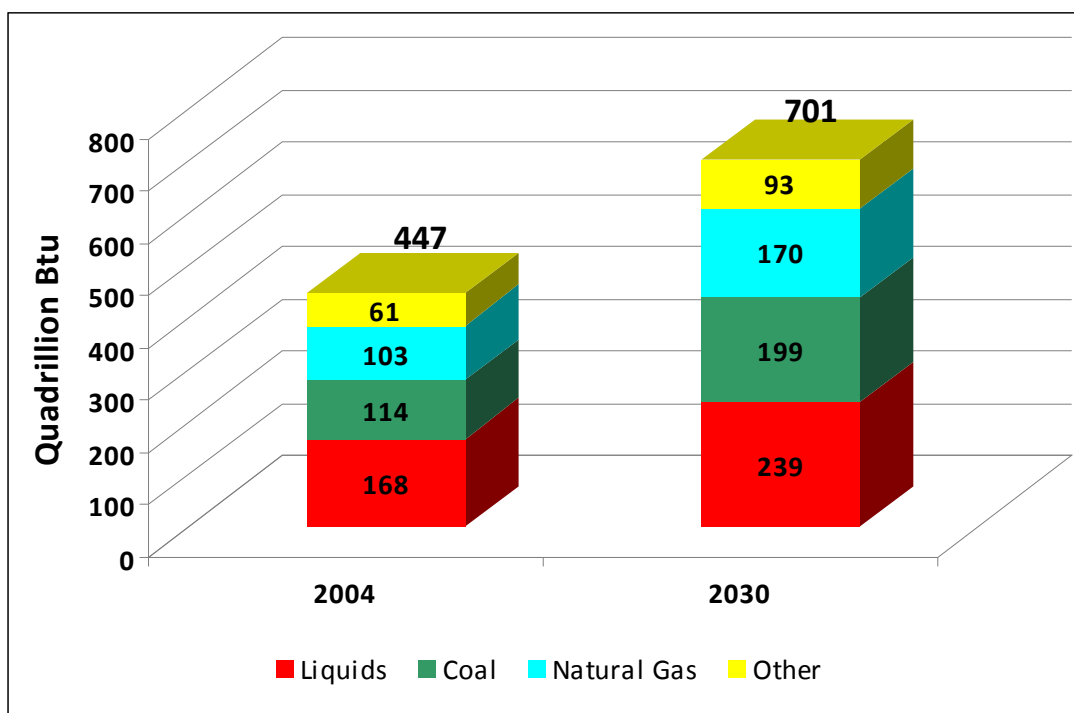

Source: Energy Information Administration, International Energy Outlook

Figure 1.10. Energy Demand is a Rising Tide, 2007

The demand for electricity, liquid fuel, and natural gas is a steadily growing drumbeat across the world. And the driving factors are macro socioeconomic trends beyond the control of any one nation or group of nations:

- (1) The **population** of the world will increase by over 1.8 billion people by 2030 – six times the population of the United States. Three currently economically underdeveloped areas will account for almost 75 percent of the growth.

Area	Increase in Millions	Percent of Global Increase
Africa	576	32
Non-OECD Asia Excluding China and India	373	21
India	362	20
Total	1,311	73

Source: EIA, 2008

Table 1.2. Population Growth by 2030

- (2) **Economic growth** is changing the face of the world. In 1990, for example, China’s Gross Domestic Product (GDP) was less than one third that of the United States and slightly

smaller than Russia's GDP. By 2030, China's GDP will be almost double that of the United States and eight times greater than Russia.

At the world level, GDP is steadily expanding decade by decade.

Year	World GDP in Trillions \$
2000	46
2010	72
2020	107
2030	154

Source: EIA, 2008

Table 1.3. Global GDP Expansion

Thus, in just a generation, world GDP will have increased 235 percent with all the concomitant impacts on energy consumption.

(3) **Modernization** is spreading across the world with far reaching consequences for energy demand. There may be no better measure for the rise of modern society than the rate of vehicle ownership. By that standard, the implications for liquid fuel consumption are broad.

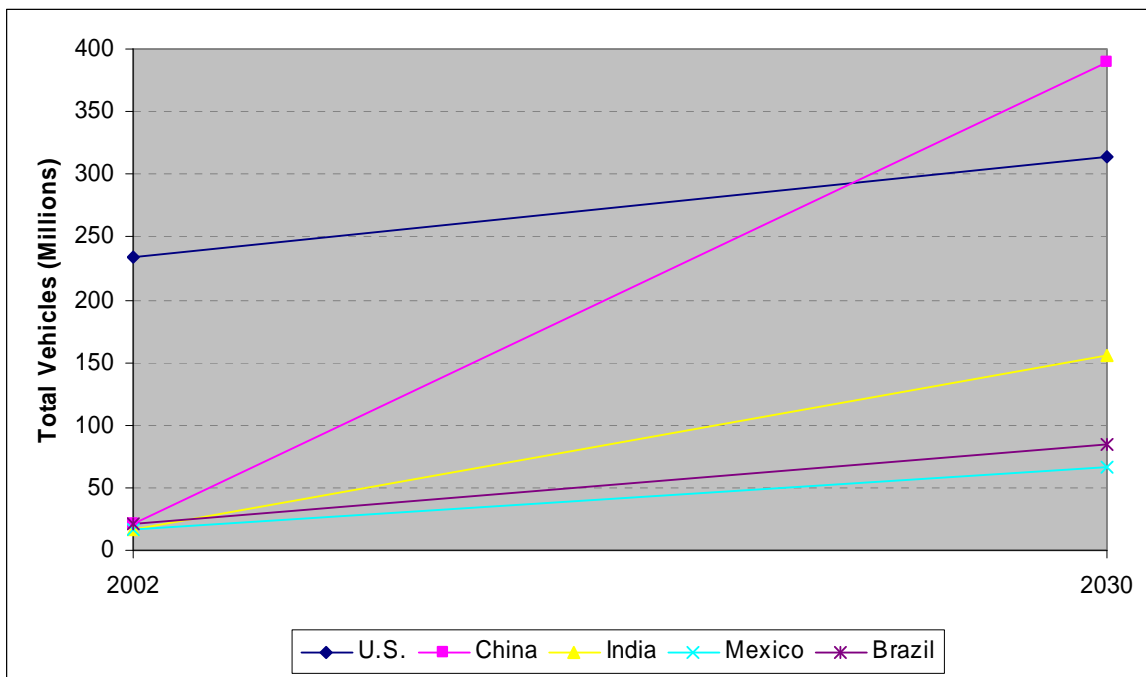

Source: Dargay ,et al. 2007

Figure 1.11. Modernization—The Rise of the Automobile

8. The Scale of Demand for Energy is Beyond Our Experience

The sea changes that are taking place in regard to population growth and economic expansion are of a magnitude the world has never seen, dwarfing the Western world's industrial revolution. Consider these comparisons:

- For every child in France, there are 30 children in India
- China now has 600 million people living in cities, Germany has 62 million
- The Middle East will increase its energy consumption by more than 17 quads by 2030; Europe will increase by 8 quads

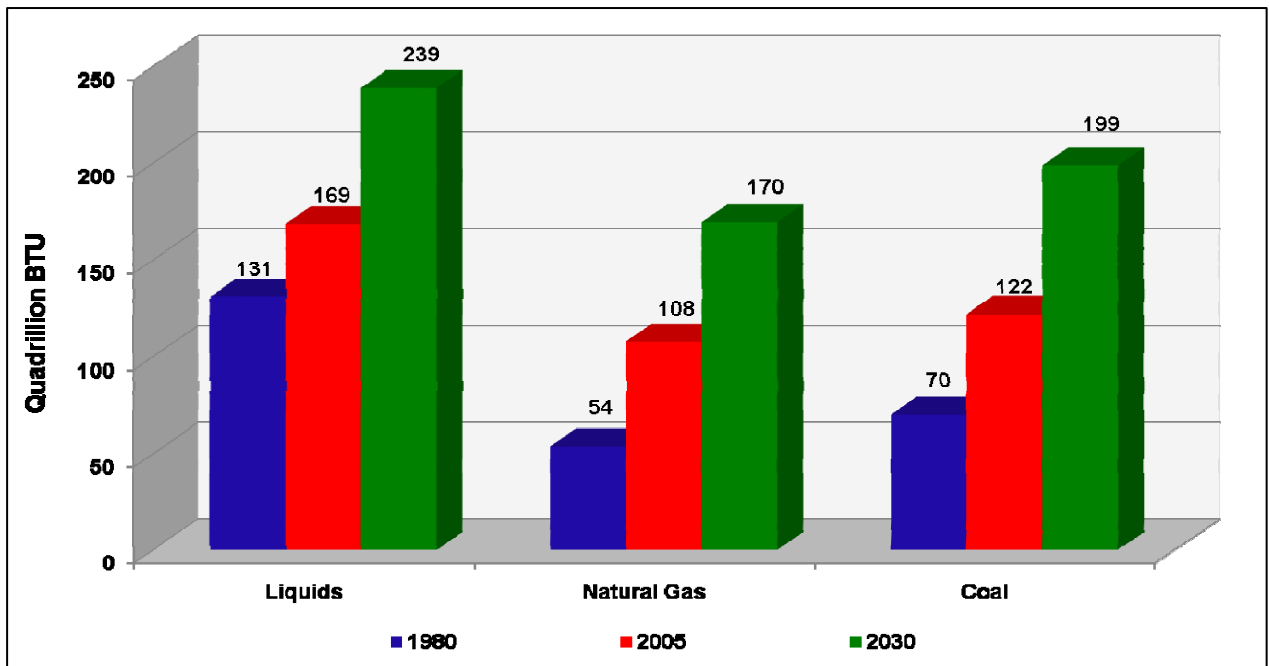

Figure 1.12. Scale Beyond Our Experience:

Incremental Energy Consumption in the Next 25 Years will be more than 50 percent Greater

Simply put, the sheer size of these economic, demographic, and social changes has no historical precedent. The world has never experienced an energy demand surge to compare with what we will face in the next 30 years.

9. New Players Are Entering the Game

Global competition for energy will pervade the first half of this century. In 1980, the United States accounted for 28 percent of the world's consumption of primary energy. By 2030, that percentage will have declined to 18 percent. The change in particular fuels demonstrates the dimensions of the emerging era in energy:

Fuel	U.S. as percent of Global Consumption		
	1980	2000	2030
Oil	26	25	22
NG	37	26	16
Coal	24	24	17

Table 1.4. U.S. as Percentage of Global Consumption

In short, the U.S. no longer has center stage in the energy drama. China, India, and other developing nations are coming onto the scene. By 2025, China will use more energy than the United States.

The changing geographic pattern of electricity demand exemplifies the competition changes taking place:

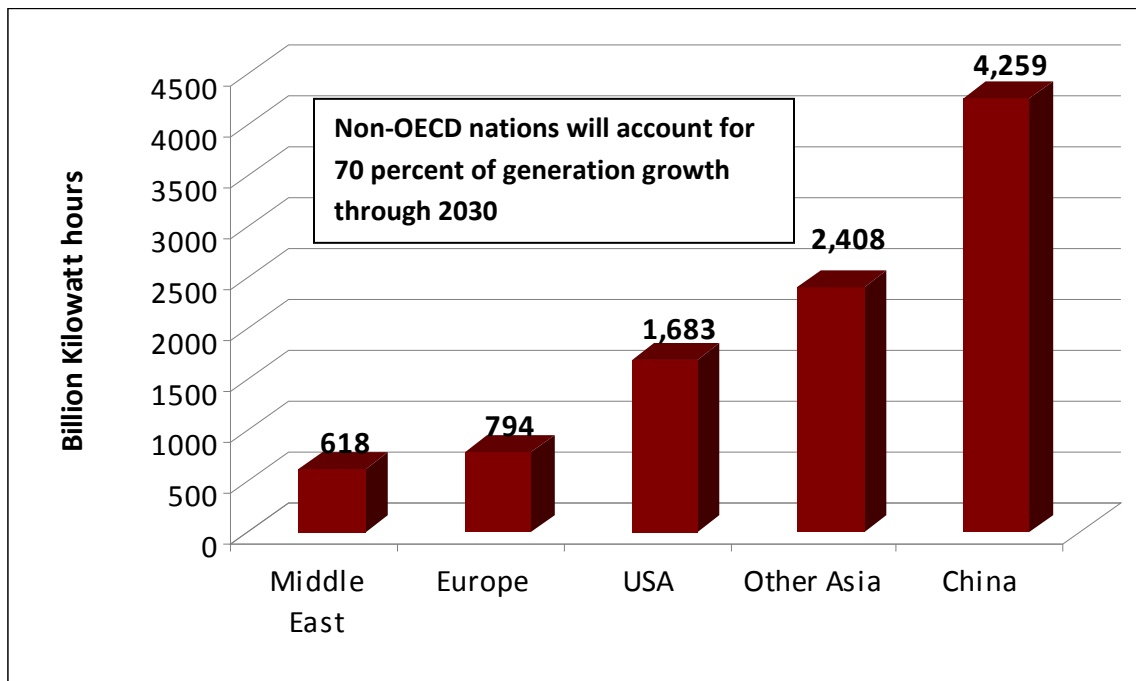

Figure 1. 13. The Locus of Electricity Generation Growth, 2004-2030

And much of this demand growth will come from previously minor consumers. Natural gas consumption in the Middle East, for example, will more than double by 2030.

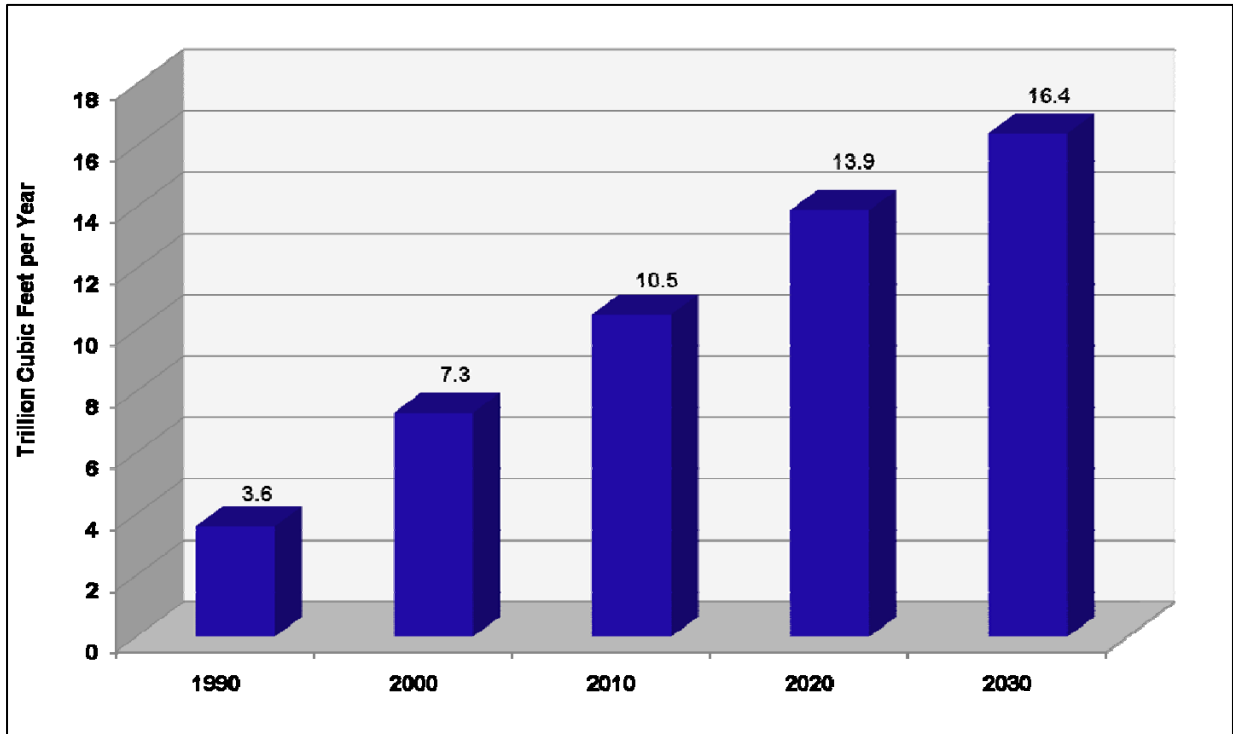

Figure 1.14. Major New Competitors: NG Consumption in the Middle East

10. The World Is Turning To Coal

As burgeoning global demand for energy becomes obvious, energy policy makers around the world increasingly recognize the central role coal must play in our future. Consider for instance, the sheer scale of projected additional needs by 2030:

- Electricity: 14,000 additional billion kWh of generation more than the entire world used in 2000.
- Liquid fuel: 33 million more barrels each day—over 3 times the current production of Saudi Arabia.
- Natural gas: 63 more TCF each year—more than three times the production the United States

Current construction and planned construction of new generation capacity, for example, verifies that coal based electricity is an integral part of energy policy across the world.

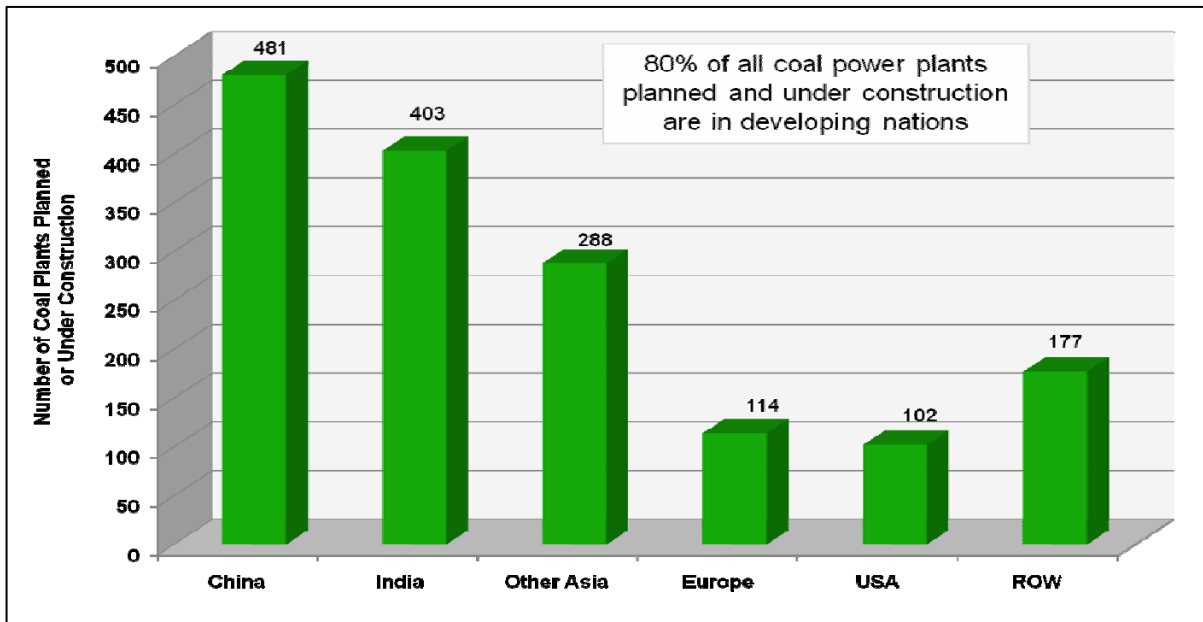

Source: Data Derived from Platt's Database, 2008

Figure 1.15. The Developing World is Turning to Coal-Based Generation

Projections from the EIA through 2030 support the observed trend to significantly increased reliance on coal-based generation.

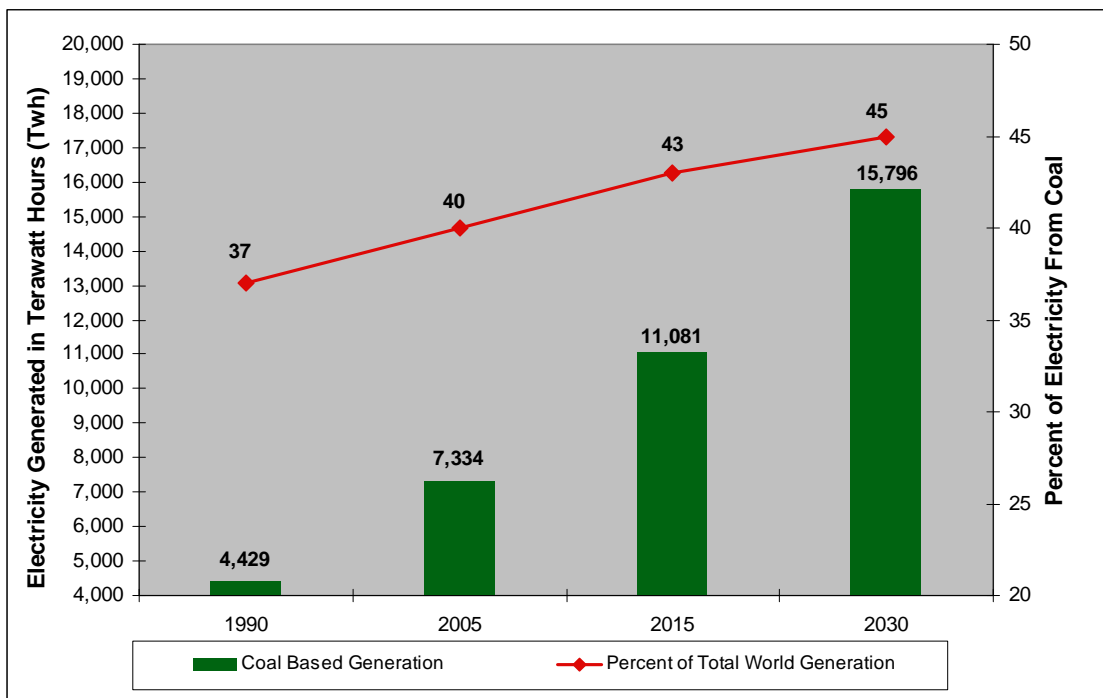

Source: IEA, 2007

Figure 1.16. World Coal-Based Electricity Generation

It is impossible for the world to meet demand growth of this magnitude without coal conversion to electricity, liquid fuel, and SNG. Billions of people will be relying on coal to meet their needs and improve the quality of life.

ENERGY IS THE PATHWAY TO A BETTER LIFE ACROSS THE WORLD

Energy in general, and electricity in particular, represent the lifeblood of modern society. Both economic and social progress depends upon energy that is available, adequate, reliable, and affordable. Across the globe, energy deprivation takes a heavy toll on the human condition as billions toil grimly in the dark. People in nations without access to sufficient energy are far more likely to live shorter lives, drink polluted water, suffer hunger and disease, and be illiterate than their more fortunate counterparts in other parts of the world.

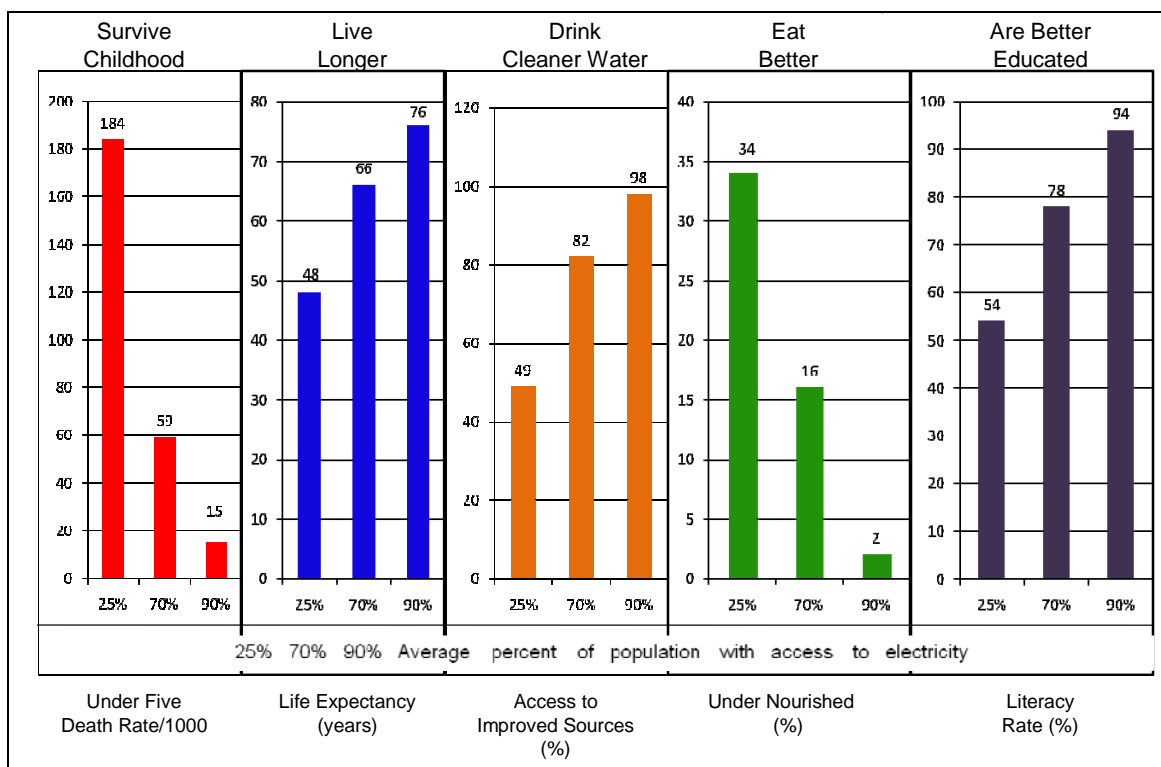

Figure 1.17. Access to Electricity and the Quality of Life

People in Societies with Greater Access to Electricity

Indeed, leading organizations have explicitly drawn the connection between electricity and socioeconomic progress:

- In the 1990s, the U.S. Academy of Engineering identified societal electrification as the “most significant engineering achievement” of the past century.
- In 2004, the Global Energy Network stated that “Every single one of the United Nations Millennium Development Goals requires access to electricity as a necessary prerequisite.”

As the debate over the impact of energy development continues, participants should keep in mind that an insufficient energy supply be measured in the most bleak terms—hunger, illness, poverty, despair and premature death.

This latest report from the Council explicitly recognizes that adequate access to energy will improve the lives of all people across the world. As clean coal technologies such as CCS continue to evolve, they will unlock the full power of coal conversion to produce more electricity, liquid fuels, substitute natural gas, chemicals, and hydrogen. Coal’s long history of making the world a better place is only a prologue to the future.

REFERENCES

- Energy Information Administration (EIA). *International Energy Outlook 2007*, DOE/EIA 0484 (2007); Washington, D.C., May 2007.
- Energy Information Administration (EIA) Website: <http://www.eia.doe.gov/>
- Dargay, Joyce, Dermot Gately and Martin Sommer. “Vehicle Ownership and Income Growth, Worldwide: 1960-2030.”
- International Energy Agency. “World Energy Outlook 2007: China and India Insights”; 2007.
- National Coal Council. *Coal: America’s Energy Future*. Washington, D.C., March 2006.
- National Coal Council. “Opportunities to Expedite the Construction of New Coal-Based Power Plants”; 2004.
- National Coal Council. “Technologies to Reduce or Capture and Store Carbon Dioxide Emissions”; June, 2007.
- Platts Power Plant Data Base, 2008, <http://www.platts.com/>

Chapter Two

Carbon Management Technology Options

Coal is a stably priced, affordable, domestic fuel that can be used in an environmentally responsible manner. Over the past three decades, advanced pollution control technologies have been developed to meet regulatory programs, resulting in a more than 90 percent reduction of regulated air emissions from new coal-based power plants.

FINDINGS

The National Coal Council finds the following. Each finding is of equal importance.

- 1 Reducing Carbon Dioxide (CO₂) emissions from coal-based power plants is an enormous challenge. However, the electric power industry, technology producers, equipment manufacturers, academic and research organizations, and the federal government are rapidly developing solutions that will secure coal's place as an important fuel source even in a carbon-constrained world.
- 2 Improvements in supply-side efficiency must play an important role in both near- and long-term CO₂ emissions reductions.
- 3 For the existing fleet of coal-based boilers -- 320 gigawatts -- the potential for the greatest CO₂ emissions reduction lies in the development of retrofit technologies.
- 4 Wholesale replacement of existing generating units cannot be accomplished in the near future. Besides daunting economic consideration, small subcritical units, with their high responsiveness to load demand fluctuation, contribute significantly to a robust portfolio of generation technologies.
- 5 The U.S. Department of Energy (DOE), in conjunction with other federal agencies such as the U.S. Department of Agriculture (USDA), should undertake studies examining the effects of renewable electricity policies on users and producers of biomass, as well as options for long-term agricultural and silvicultural capability. DOE also should work within the administration to promote energy production from biomass removed from federal lands to reduce the threat of wildfire and insect infestations.
- 6 The parasitic power and water requirements are high with current CO₂ capture technology. For example, if CO₂ emissions were reduced by 90 percent across the existing fleet, the 320 gigawatt capacity would be reduced by 96 gigawatts.
- 7 Initial work with post-combustion CO₂ capture technologies suggests we can potentially reduce the current estimated 30 percent energy penalty associated with carbon capture and storage (CCS) to about to 15 percent over the long term.
- 8 The existing fleet of 1,100 boilers varies in design, size, operation, age, coal characteristics and location. Therefore, a variety of technologies and approaches are necessary to provide sufficient options for the fleet.
- 9 The availability of advanced coal power and integrated CCS and other technologies could dramatically reduce the projected increases in the cost of wholesale electricity under a carbon cap, thereby saving the United States economy as much as \$1 trillion by 2050.
- 10 Coal power plant technologies with integrated CO₂ (CCS) will be crucial to lowering United States electric power sector CO₂ emissions. They will also be crucial to substantially lowering world CO₂ emissions.

- 11 There will inevitably be additional costs associated with CCS. Latest estimates suggest that the levelized cost of electricity (COE) from new coal plants (IGCC or supercritical Pulverized Coal) designed for capture, compression, transportation and storage of the CO₂ will be 40 to 80 percent higher than the COE of a conventional supercritical Pulverized Coal (SCPC) plant.
- 12 Research, Development, and Demonstration pathways have been identified to demonstrate by 2025, a full portfolio of economically attractive, commercial-scale advanced coal power and integrated CCS technologies suitable for use with the broad range of U. S. coal types. Some technologies will be ready for some fuels sooner, but the economic benefits of competition will not be realized until the full portfolio is developed.

RECOMMENDATIONS

The NCC makes the following recommendations:

1. It is important to avoid choosing prematurely between clean coal technology options. Therefore the Secretary of Energy should coordinate with other federal and state funding groups to support and help advance a full portfolio of technology options for the electric power industry.
2. The Secretary of Energy, U.S. Environmental Protection Agency, and Congress must work together to remove the regulatory hurdles that impede the implementation of supply efficiency enhancements, including a more workable New Source Review.
3. The key to proving CCS capability is the demonstration of CCS at large-scale (on the order of 1 million tons CO₂/year) for both pre- and post-combustion capture with storage in a variety of geologies. Therefore, the Secretary should solicit from Congress funding for large combined capture and storage demonstrations to be conducted in different regions and with different coals and technologies.
4. The United States is a leading developer of clean coal technology. Since carbon management and climate change is a global issue, the Secretary of Energy should support efforts by international trade associations and federal agencies to enable the transfer of technology to countries such as India and China, which are responsible for much of the growth in carbon emissions.

INTRODUCTION—THE GENERATION OF POWER AND CO₂

Fossil fuels are currently to meet 80 percent of the energy demand in the United States. All fossil fuels are hydro-carbon-based. When these fuels are combusted, one of the products will inevitably be carbon dioxide. When mixed with air and exposed to elevated temperature, the carbon reacts with oxygen in air according to the following chemical reaction:



These reactions are highly exothermic, and thus the combustion of fossil fuels results in the generation of large amounts of heat. This heat release is then converted to either electrical energy used for power generation or mechanical energy used in transportation and machinery.

The amount of carbon dioxide that will be generated from the process will depend upon the concentration of carbon in the fuel.

Figure 2.1 shows the basic components and operation of a conventional coal-based steam electric station. The energy released from coal combustion is used to heat water until it has been converted to high-pressure steam, which impacts the blades of a turbine and causes both the turbine and the generator to turn. A magnetic field is created, resulting in electricity, which is then distributed across the grid to homes, businesses, and industries alike. Emissions of gases such as oxides of nitrogen, oxides of sulfur, mercury, and particulates can be controlled by current technologies.

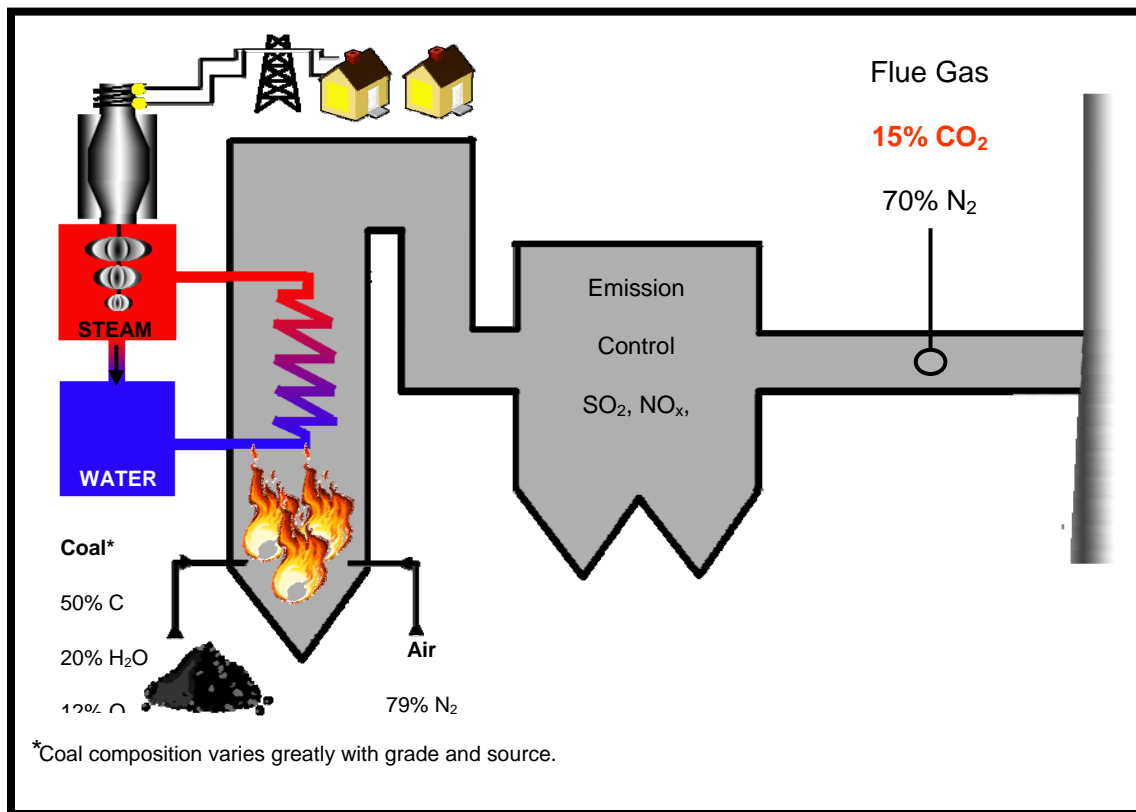

Figure 2.1 Conventional Coal-Based Electric Station

This chapter provides background information on the options for managing carbon dioxide generated during the combustion of coal. Each ton of coal produces approximately 2 tons of gaseous CO₂, although the exact amount is highly dependent on the fuel type and grade. Approaches to carbon management cover a wide spectrum, including the reduction of the amount of CO₂ generated through efficiency improvements, co-firing with biomass and the employment of emerging technologies for capturing CO₂ and advanced combustion techniques. After the carbon is separated and captured as pure CO₂, it can be compressed and sequestered or stored without entering the atmosphere. Although this chapter will discuss compression, issues related to sequestration will be discussed in detail in subsequent chapters.

A variety of options are necessary because there is no universal answer to carbon management that is appropriate for all coal-based power plants. Some technology solutions that can be applied to the new power plants are not always suitable for the existing fleet of power plants in the United States, which are producing 320 gigawatts of electricity. Therefore, to effectively address concerns about climate, it is necessary that technologies be developed that can manage carbon emissions from conventional plants.

Carbon reduction can be achieved using technologies that are available today for decreasing energy needs by the consumer (demand side) and increasing generation efficiency at the power plant (supply side). This report will detail information on supply-side technologies, but will not discuss demand-side efficiency improvements, such as using energy efficient light bulbs, purchasing energy efficient appliances, and decreasing the temperature of the thermostat during winter.

It must be noted that most of the technology options discussed in this chapter are in the early stages of development and will require a great deal of Research and Development to overcome current technical limitations, to produce innovations, and to further advancements needed to demonstrate the viability of each approach. This will require substantial Research and Development funding and adequate time to develop, scale-up, and complete long-term testing to prove reliability. It is also important to recognize that because of the many differences in plant design, operating parameters and location, effectively addressing CO₂ from power generating facilities will require a wide array of technologies; there will not be a “silver bullet” that can be implemented universally. Although some power stations are ideally located for sequestration, many are not. Plants whose location makes sequestration of CO₂ economically unfeasible will need to either improve efficiency, consider using biomass as a partial fuel source, or implement other options discussed in this chapter. Similarly, many facilities do not have access to large amounts of biomass; carbon emissions generated during long transport of biomass fuel sources will negate the emission benefits offered from using biomass as a fuel.

Funding for Research, Development and Demonstration (RD&D) of carbon management technology will reduce risk to the electrical supply for the nation and it can also be expected to result in reduced costs for the technologies as they mature. This is critical because current estimates for 90 percent CCS applied to the current fleet of 320 gigawatts of coal-based power plants would result in a total capital cost of \$256 to \$512 billion (the projected capital cost to retrofit pulverized coal (PC) plants is expected to be within the range of \$800 - \$1600 per kilowatt hour, depending on the type and age of the plant, fuel type and available space) and result in a reduction of power produced by at least 30 percent or 96 gigawatts. Thus, reductions in CO₂ capture costs and parasitic energy requirements are of vital importance. Another key concern is the increased water consumption due to the implementation of CCS; it is important that technology development address both parasitic power and water needs.

Although the challenge of reducing the world’s CO₂ emissions seems enormous, the utility industry, emissions control industry, and the federal government are rapidly developing solutions that will continue to secure coal’s place as an important fuel source, even in a carbon-conscious

world. This chapter explores the many carbon management options for coal-based electricity generation.

CO₂ MANAGEMENT OPTIONS FOR EXISTING POWER PLANTS

While building new, high-efficiency capacity offers lower CO₂ emissions rates per kilowatt hour of electricity produced, a wholesale replacement of existing generating units cannot be accomplished in the near future. Premature replacement of these units or mandatory retrofit of these units for CO₂ capture en masse would be economically prohibitive. Besides daunting economic consideration, the subcritical units play a key role in reliable power generation. These units have a more robust capability for load following and significant load turn-down during non-peak times, which is essential to meeting the peaks and valleys associated with load demand on the grid. Small, subcritical units, with their high responsiveness to load demand fluctuation, contribute significantly to a robust portfolio of generation technologies.

With this in mind, the greatest potential for reducing emissions of CO₂ from the existing fleet is in the development of retrofit technologies that can be applied to these boilers, generating 320 gigawatts of power. These 1,100 boilers vary in design, size, operation, age, coal characteristics and location. Therefore, a variety of technologies and approaches are necessary. These options include technology that is available today for efficiency improvements as well as early-stage developmental technology for separating CO₂ from flue gas. They also include alternatives such as low-cost improvements to combustion efficiency that can reduce carbon emissions by a percentage point with a moderate capital investment. The more expensive options include extensive boiler rebuilds that can reduce carbon emissions by 25 percent, as well as high-cost carbon capture technologies capable of making 90 percent of the carbon available for sequestration.

With equipment upgrades, many of these units can realize modest efficiency gains, which, when accumulated across the existing generating fleet, could lead to a sizeable reduction in CO₂ emissions. For some existing plants, retrofit of CCS will make sense, but specific plant design features, such as space limitations and economic and regulatory considerations must be carefully analyzed to determine whether retrofit-for-capture is feasible. The technical modifications that can increase plant efficiency are discussed in the following section. These options are currently available and commercially mature. Unlike most other carbon management options, the hurdles to efficiency increases are not technical, but regulatory.

Efficiency Improvements

Improved thermodynamic efficiency reduces CO₂ emissions by reducing the amount of fuel required to generate a given amount of electricity. A two-percentage point gain in efficiency provides a reduction in fuel consumption of roughly 5 percent and a similar reduction in flue gas and CO₂ output. Because the size and cost of CO₂ capture equipment is determined by the volume of flue gas to be treated, higher power block efficiency reduces the capital and energy requirements for CCS. Depending on the technology used, improved efficiency can also provide similar reductions in criteria air pollutants, hazardous air pollutants and water consumption.

To give some perspective on the value of efficiency improvement, the average generation efficiency in 2005 for fossil steam plants was 33 percent and the resulting CO₂ emissions from the power sector were 2,450 million tons. If the national average heat rate could be reduced by 100 Btu per kilowatt hour, which will be a challenge across the board, CO₂ intensity would be reduced by 1 percent resulting in a reduction of over 29 million tons. Improvements in heat rate are available with currently existing technology, and are segregated into several performance areas of a power boiler: combustion efficiency, superheat steam temperature and pressure, exit gas temperature, surface condenser performance, and efficiency of auxiliary equipment.

In some cases, there are regulatory and policy impediments to timely deployment of these currently existing technologies and these are discussed in Chapter 3. As emphasized in previous NCC reports, it is of the utmost importance that regulatory policies, including the New Source Review (NSR), be modified so that efficiency improvements are encouraged, not discouraged. NSR rules apply to “modifications” of existing facilities that result in new, unaccounted for pollution. For the first 20 years of these programs, the U.S. Environmental Protection Agency (EPA) identified only a handful of “modifications.” In 1999, however, EPA sued several major utility companies for past availability and efficiency improvement projects like those described above, characterizing them as modifications subject to NSPS and NSR. EPA has further indicated that it will treat innovative component upgrades that increase efficiency or reliability without increasing a unit’s pollution producing capacity as modifications as well. EPA’s current approach to these projects strongly discourages utilities from undertaking them, due to the significant permitting delay and expense involved, along with the retrofit of expensive emission controls that are intended for new facilities. Currently, this is the greatest barrier to increased efficiency at existing units.

These upgrades depend on the equipment configuration and operating parameters of a particular plant and may include:

- turbine blading and steam path upgrades
- turbine control valve upgrades for more efficient regulation of steam
- cooling tower and condenser upgrades to reduce circulating water temperature, steam
- turbine exhaust backpressure and auxiliary power consumption
- cooling tower heat transfer media upgrades
- condenser optimization to maximize heat transfer and minimize condenser temperature
- condenser air leakage prevention and detection
- variable speed drive technology for pump and fan motors to reduce power consumption
- air heater upgrades to increase heat recovery and reduce leakage
- advanced control systems incorporating neural nets to optimize temperature, pressure, and flow rates of fuel, air, flue gas, steam and water
- optimization of water blowdown and blowdown energy recovery
- optimization of attemperator design, control, and operating scenarios
- sootblower optimization via “intelligent” sootblower system use
- coal drying for plants using lignite and sub-bituminous coals

Heat rate reductions will also result in decreases in other emissions such as nitrogen oxides, sulfur dioxide and mercury, which can help plants meet other compliance requirements. It should be appreciated that, even for a constant pounds per million Btu of pollutant emitted, an improvement in heat rate will result in fewer Btus fired, and consequently, fewer total pounds of a given pollutant produced. Another advantage is that, under deregulation, as utilities dispatch plants within a fleet, heat rate improvement can earn plants a better position on the dispatch list.

Specific Technologies to Improve Heat Rate

For individual coal-based units, the potential heat rate improvement that can be obtained via implementation of a given technology will be highly variable. The biggest factor is the existing baseline: if a plant has previously focused on optimizing heat rate, there may not be much room for improvement. On the other hand, if heat rate has not previously been given much attention, a substantial amount of improvement may be possible.

Below are technologies for heat rate improvement classified in terms of three nominal levels of efforts, which have been termed “minor,” “average,” and “major.” Here again, it must be appreciated that the cost needed to implement any given technology as well as the performance improvement realized will be highly site specific. For rate case inclusion purposes, the technologies are also categorized as either “Operating Expense” or “Capital Equipment.”

1. **Minor Investments.** Technologies in this category cost in range of under \$1 million, and typically yield a heat rate improvement in the range of half of a percent to one percent. Improvements are highly site specific. Examples of items in this category include:
 - Combustion tuning which includes low excess air operation, fuel/air balancing and mill performance improvements—**Operating Expense/ Capital Equipment**
 - Reduction of steam side losses, (e.g., turbine steam seals leakage, feedwater flow nozzle calibration, and low-pressure turbine efficiency measurement) —**Operating Expense**
 - Installation of heat rate monitoring hardware, along with heat rate awareness courses for plant operators— **Operating Expense/ Capital Equipment**
 - Implementation of on-line performance monitoring system—**Capital Equipment**
 - Chemical addition to surface condenser cooling water for cleanliness factor improvement—**Operating Expense**
 - Deployment of chemical programs to modify fireside deposit character—**Operating Expense**

2. **Average Investments.** Technologies in this category cost in range of up to \$10 million, and may yield a heat rate improvement in the range of a percent, depending on the application. Examples in this category include:
 - Implementation of commercial software based optimization systems—**Capital Equipment**
 - “Intelligent” sootblowing systems—**Capital Equipment**
 - Flame diagnostic systems such as the EPRI Flame Doctor—**Capital Equipment**

- Utilization of advanced (near commercial) sensors for mapping of critical gas s (CO, O₂) —**Capital Equipment**
3. **Major.** Technologies in this category can cost well in excess of \$10M, but may yield a heat rate improvement of 1-2 percent or greater. Examples of items in this category include:
- Major modifications or upgrades to condensers (e.g., to improve back pressure) —**Capital Equipment**
 - Major modifications or replacement of mills (e.g., to improve particle size distribution) —**Capital Equipment**
 - Installation of higher efficiency large motors (e.g., circulation water pump motors) and/or variable speed drives—**Capital Equipment**
 - Cooling tower optimization (e.g., reduced cells in service during winter operation) —**Expense Equipment**
- **Capital Investments to Improve Heat Rate.** By changing the operating conditions, the efficiency of PC/SC power plant can be increased in small steps to 43% (HHV) and beyond, as is illustrated in Figure 2.2.

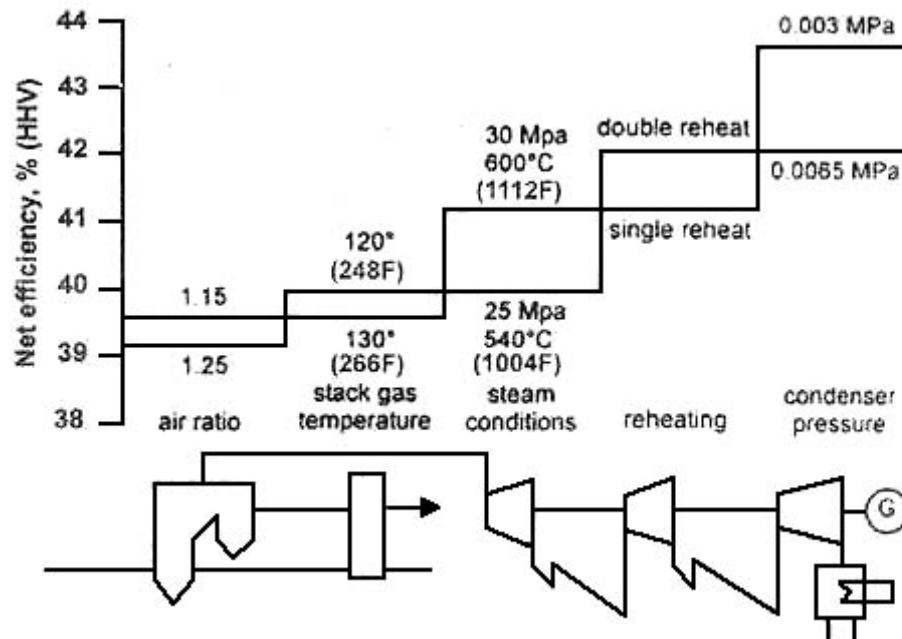

Figure 2.1. Effect of Various Measures for Improving the Efficiency (HHV) of PC Coal Fired Power Generating Plant (Schilling VGB)

The first two steps in the diagram concern the waste gas heat loss, the largest of a boiler's heat losses, about 6 to 8 percentage points. The air ratio, usually called excess air factor, represents the mass flow rate of the combustion air as a multiple of the theoretically required air for complete combustion. The excess air increases the boiler exit-gas mass

flow and hence, the stack gas heat loss. Improved combustion technology including finer coal grinding and improved burner design permit lowering the excess air without sacrificing completeness of combustion.

The boiler exit gas temperature can be reduced by appropriate boiler design limited only by the dew point of the flue gas. There is a close relationship between the excess air of combustion and the low limit of exit gas temperature from a boiler fired by a sulfur bearing fuel. At an exit gas temperature of 130°C (266°F), a reduction of every 10°C (18°F) in stack temperature increases the plant efficiency by about 0.3 percent.

- **Steam Side Changes to Improve Heat Rate.** As steam pressure and temperature are increased to beyond 221 atm (3208 psi) and 374.5°C (706°F), the steam becomes supercritical, it does not produce a two-phase mixture of water and steam and it does not have a saturation temperature or an enthalpy range of latent heat. Instead, it undergoes gradual transition from water to vapor with corresponding changes in physical properties such as density and viscosity. The steam, after partial expansion in the turbine, is taken back to the boiler to be reheated. Supercritical steam is a mature technology worldwide including in the United States.

The items listed above are a sampling of options that can offer measurable increases in unit output and/or reduction in CO₂ emissions. In a recent study by American Electric Power (AEP), presented to the Asia Pacific Partnership in September 2006, AEP estimates these types of equipment upgrades would yield reductions of more than 3.5 million tons of CO₂ per year across its generation fleet. Efficiency upgrades also can be implemented in conjunction with retrofits of other air pollution control equipment, such as selective catalytic reduction (SCR) and/or flue gas desulfurization (FGD), to offset associated parasitic losses.

In addition to the CO₂ reduction, optimizing heat rate brings significant fuel cost savings. In the example above, and assuming a fuel cost of \$2 per million British thermal units (million Btu), the plant also would realize \$700,000 a year in fuel savings for the same 1 percent heat rate improvement.

- **Deposit Treatment.** In cases where the options for better coal quality are minimal, optimized deposit treatment programs that facilitate deposit removal by sootblowing or other means may be necessary. Often, a chemical is applied to the fuel to reduce deposits. A more intricate solution includes specifically targeting the problem areas of the furnace. In this approach, treatment chemicals are injected into the flue gas. Computational fluid dynamics (CFD) can provide valuable insight, ensuring that the injected chemicals achieve maximum coverage where problem areas are known to exist. The additive interacts with the slag as it is forming and penetrates existing deposits. Application of this technology has demonstrated heat rate improvements of 120 Btu/kilowatt hours.
- **Coal Quality.** An improved understanding of the interplay between coal quality and the performance of a specific boiler can lead to significant increases in boiler efficiency at

little or no cost to the utility because the cheapest coal does not necessarily produce the cheapest electricity or produce the lowest CO₂ emissions. The potential for improved boiler efficiency by selection of the optimal fuel quality is especially high in cases in which a boiler is fed a fuel that is below design specifications. Other benefits of burning higher quality coal can include increased capacity, reduced maintenance, increased availability, reduced emissions, and reduced tonnage of ash for disposal.

There are a number of processes either in operation or under development to make coal a cleaner fuel before it is combusted. These “pre-combustion” clean coal technologies produce products that result in lower SO₂, NO_x, Hg, and, to a lesser-known extent, CO₂ air emissions at plants that burn them. Pre-combustion clean coal technologies generally involve modifying coal’s characteristics prior to combustion to achieve improved efficiency and environmental performance in existing and new coal-fueled boilers. The types of modifications made to coal and its characteristics fall into three categories — coal preparation, upgrading and treatment.

- **Coal Preparation.** Coal preparation is the most widely used form of pre-combustion clean coal treatment. The following three technologies are used for cleaning coal prior to combustion:

- Wet cleaning
- Dry cleaning
- Chemical or microbial cleaning

Cleaned coal contains significantly lower ash than non-cleaned coal and, when burned, results in lowered SO₂ and mercury emissions because the cleaning processes mechanically remove the sulfur and mercury found in the coal’s ash. In addition, by producing a higher quality product, plants that burn cleaned coal experience improved fuel combustion efficiency and this results in reduced NO_x and CO₂ emissions. To the extent that waste coal is used for feedstock into the coal preparation plants, additional environmental benefits result from the recovery and reclamation of a previously wasted resource.

- **Coal Upgrading/Drying.** Coal upgrading technologies operate on the principle of removing moisture from lower-ranked coals, thus increasing the Btu content (i.e., energy density) of the end product. These technologies fall into four groups, the first three of which are thermal while the fourth is non-thermal:

- Direct heat—using saturated steam to dry the coal
- Indirect heat—using waste heat or re-circulated waste gas to dry the coal
- Briquetting—using heat and pressure to drive off the moisture contained in the coal
- Electromagnetic energy—used to drive off the moisture contained in the coal

By driving off much of coal’s moisture, its sulfur and mercury content is reduced, as are the SO₂ and mercury emissions from burning upgraded coal. The increased heat content of the coal results in lower NO_x per kilowatt hour generated. The increased fuel and boiler efficiency realized when burning upgraded coal leads to lower CO₂ emissions per kilowatt hour generated. However, any CO₂ generated during the treatment of the coal to increase the heat content will have to be considered when evaluating coal upgrading as an approach to carbon management.

Boilers designed for high-moisture lignite have traditionally employed higher feed rates (lb/hr) to account for the large latent heat load to evaporate fuel moisture. An innovative concept developed by Great River Energy (GRE) and Lehigh University uses low-grade heat recovered from within the plant to dry incoming fuel to the boiler, thereby boosting plant efficiency and output. (In contrast, traditional thermal drying processes are complex and require high-grade heat to remove moisture from the coal.) Specifically, the GRE approach uses steam condenser and boiler exhaust heat exchangers to heat air and water fed to a fluidized-bed coal dryer upstream of the plant pulverizers. Based on successful tests with a pilot-scale dryer and more than a year of continuous operation with a prototype dryer at its Coal Creek station, GRE with DOE support and EPRI technical consultation now building a full suite of dryers for Unit 2 in a commercial-scale demonstration. In addition to the efficiency and CO₂ emission reduction benefits from reducing the lignite feed moisture content by about 25 percent, the plant's air emissions will be reduced. Application of this technology is not limited to PC units firing lignite. EPRI believes it may find application in PC units firing sub-bituminous coal and in IGCC units with dry-fed gasifiers using low-rank coals.

- **Coal Treatment.** Coal treatment technologies use additives to alter the coal's combustion characteristics. The technologies generally use latex, metallic or mineral reagents, or sorbents to change the way the coal burns. These technologies can capture sulfur and mercury in solid byproducts from the generating process rather than allowing these coal constituents to be emitted in power plant exhaust gases. In addition, combustion efficiency improvements result in lower NO_x and CO₂ emissions per kilowatt hour generated.

Oxycombustion

When coal is burned with air, most of the flue gas consists of N₂, leading to the high costs associated with CO₂ separation. Oxycombustion addresses the issue of dilute, voluminous flue gas by burning coal with oxygen, instead of air. This process requires the addition of an air separator, which provides oxygen to the boiler. This modification can be implemented at both new and existing power plants. When oxycombustion is utilized, CO₂ becomes the main component in the flue gas and separation costs are radically reduced. There is great interest in the implementation of CO₂ capture, but the parasitic energy associated with CO₂ separation is overwhelming; oxycombustion is a potential key to this problem.

When oxygen, instead of air is used during combustion, the mass flow rate of combustion products is significantly reduced with the important consequence of increasing combustion temperature. By recirculating cooled combustion products, mainly CO₂, from the end of the boiler to the furnace, the combustion products are diluted. The flame temperature and furnace exit gas temperature can be restored to air combustion levels.

Flue gas recirculation (FGR) increases the CO₂ concentration in the flue gas to beyond 90 percent, (the complement being N₂ mainly due to air leakage and about 3 percent O₂ required for

complete burn out of coal), making the flue gas ready for sequestration without energy-intensive gas separation. It is possible that corrosion danger of the compressor and pipeline will require post combustion gas clean up. In this case, gas volume to be processed has been reduced by a factor of five. The emissions control for mercury, particulates, and sulfur emissions have the benefit of reduced capital and treatment costs due to the significantly lower gas volume. In addition, the Oxy/FGR system negates the need for a NO_x Selective Catalytic Reductor (SCR) because of the very low NO_x. Boiler and flue gas treatment schematics for air fired and oxygen fired operation, respectively, are shown in Figure 2.3.

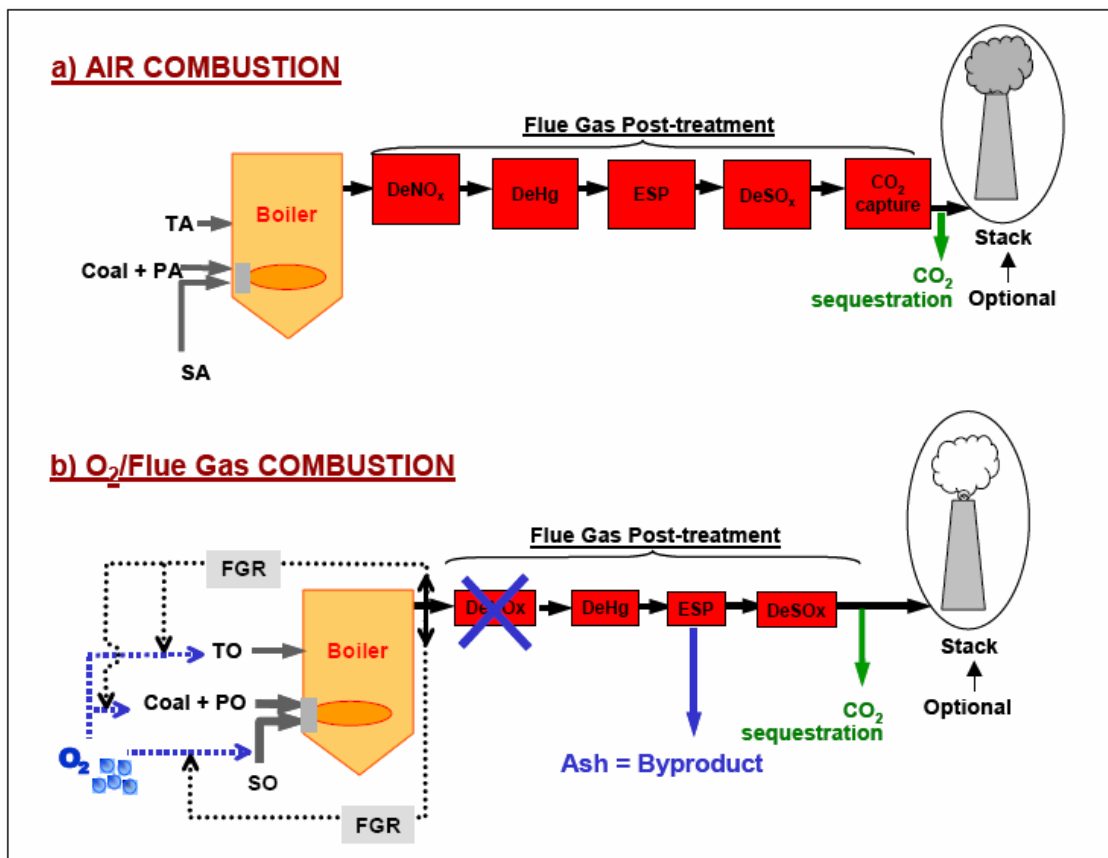

Figure 2.2. Schematic of PC Combustion with a) Air, and b) Oxy-Flue Gas Recirculation (Sangras et al., 2004)

There are currently eight large pilot or demonstration projects underway worldwide to prove oxycombustion as a carbon capture solution. The largest oxy-coal combustion project to date commenced at the B&W 30 MWth pilot test facility in Ohio in 2007, burning eastern bituminous coal. Additional test runs will be conducted, at least through spring 2008, with sub-bituminous and lignite coals. Results of the project to date are encouraging, and corroborate prior small pilot testing done by B&W.

Oxycombustion allows for a reduction in the cost associated with carbon capture. However, oxycombustion plants are expected to decrease in efficiency with the implementation of CCS.

Figure 2.4 shows the factors contributing to such a loss in efficiency at an oxycombustion supercritical PC plant.

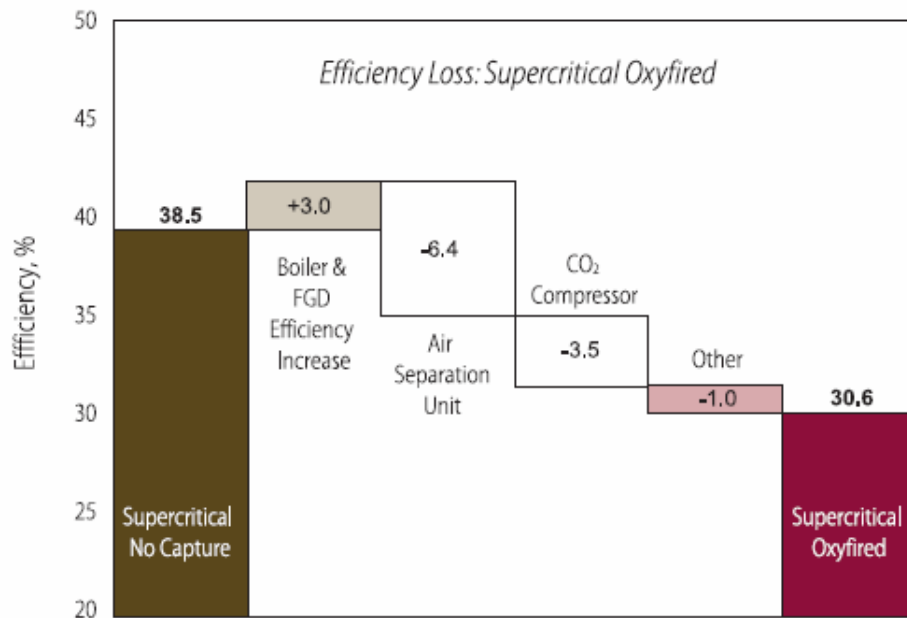

Figure 2.3. Parasitic Energy Requirement for PC/Oxy/SC with Capture vs. Supercritical PC without CO₂ Capture (MIT,2007)

Commercialization of oxy-coal combustion for utility applications will require large at-scale demonstrations. The demonstration projects will provide confidence in performance and cost projections, and enable identification and development of opportunities for further overall system improvements—such as through integration/synergy of subsystems, reductions in parasitic energy requirements, and reductions in capital equipment costs. The at-scale demonstrations, which are vital to enable commercialization, will be costly. Government-industry partnerships will be required to cover the added costs and risks associated with the CCS portions of the projects.

CO₂ Management Using Biomass

Co-Firing with Biomass

Another option for carbon management is to co-fire coal with biomass. Biomass co-firing involves combining biomass material with coal in existing coal-based boilers. Coal-based boilers can handle a pre-mixed combination of coal and biomass in which the biomass is combined with the coal in the feed lot and fed through an existing coal feed system. It is possible to use this approach to reduce carbon emission on both existing coal-based boilers and IGCC units. For this to be a viable option, the plant must have access to a steady supply of the biomass material.

When biomass is burned, it releases the CO₂ absorbed during its life, greatly reducing the amount of additional carbon vented into the atmosphere. A closed-loop process occurs when power is generated using feedstocks that are grown specifically for the purpose of energy

production. Many varieties of energy crops are being considered, including hybrid willow, switchgrass and hybrid poplar. If biomass is utilized in a closed-loop process, the entire process -- planting, harvesting, transportation, and conversion to electricity -- can be considered to be a small but positive net emitter of CO₂. In addition, when more than 10 percent of the fuel is biomass (on a mass basis) significant reductions in SO_x and NO_x emissions are also observed.

An open-loop process refers to other biomass feedstock sources that are not grown specifically for energy production, but can also be the feedstock for existing fiber markets. The potential impact on existing manufacturing and other sectors that utilize existing regional feedstock supplies is a concern to traditional users of biomass, such as some manufacturers within the forest products industry. It is important that regulatory policies take into account the impacts to existing regional fiber markets in addition to the potential for new markets and rural economic development. Impact on other industries, such as increased food pricing, will be of concern when co-firing with biomass.

In the electricity sector, biomass is currently used for power generation. The Energy Information Administration projects that biomass will generate 15.3 billion kW_e, or 0.3 percent of the projected 5,476 billion kW_e of total generation, in 2020. In scenarios that reflect the impact of a 20% renewable portfolio standard (RPS) and in scenarios that assume carbon dioxide emission reduction requirements, electricity generation from biomass is projected to increase substantially.

Although co-firing with bio-mass is a promising means of reducing the CO₂ intensity from coal-based power plants, there are many issues related to the implementation of this technology. The main issues are as follows:

- Availability of biomass (feasibility is determined by the availability and price of biomass within 50-100 miles of the plant)
- Life cycle analysis of CO₂ reductions (including growth, transportation and preparation of biomass)
- Competition of biomass with other land needs, such as food production
- Change in ash properties for plants selling flyash
- Fouling, slagging, and corrosion in the boiler
- Reduction in output

The operational issues (fouling, slagging, and corrosion) are due to the high alkali content in the biomass. The ash created by burning coal and biomass are different, which can often lead to buildup of ash on boiler tubes and surfaces. At certain conditions, the ash will fuse and fall off the surfaces, which is a significant problem for boiler operation. Notably, plants with a higher steam temperature have a reduced risk of slagging.

The percentage of coal that can be replaced with biomass is highly site specific. However, a study by EPRI estimated that co-firing can be economically advantageous at levels of >5% of the fuel (by mass). In addition, the study projected significant environmental improvements could be attained by co-firing with 10 to 30 percent biomass, mass basis.

Table 2.1 lists the power plants that currently are co-firing with biomass on a commercial basis. The portion of biomass consumed varies from less than 1 percent to about 8 percent of total heat

input, with two exceptions: Excel Energy’s Bay Front plant in Ashland, Wisconsin, and Tacoma Steam Plant Number 2, owned by Tacoma Public Utilities.

Facility Name	Company Name	State	Capacity (MW)	Heat Input of Biomass (Percent of Total)
6 th Street	Alliant Energy	IA	85	7.7
Bay Front	Xcel Energy, Inc.	WI	76	40.3
Colbert	TVA	AL	190	1.5
Gadsden	Alabama Power Co.	AL	70	<1.0
Greenridge	AES	NY	161	6.8
C.D. McIntosh, Jr	City of Lakeland	FL	350	<1.0
Tacoma Steam Plant	Tacoma Public Utilities	WA	35	44.0
Willow Island 2	Allegheny Power	WV	188	1.2
Yates 6 and 7	Georgia Power	GA	150	<1.0

Table 2.1 U.S. Plants Currently Co-Firing with Biomass (Hag. 2008)

Biochar

Biochar is an intriguing option for CO₂ management from coal-based power plants, especially for those power plants that do not have access to economically exploitable geological sequestration sites. When biomass material is burned without oxygen in a heat-evolving process called pyrolysis, approximately 50 percent of the carbon in the biomass remains in a solid form; this carbon is essentially sequestered as the solid, charred material. Biochar is not a new concept; dark soil near the Amazon Basin contains carbon from biomass charred hundreds to thousands of years ago. What makes biochar compatible with coal-based power plants is that the heat and gas generated during pyrolysis can be utilized for energy production. In fact, the gas evolved during pyrolysis can be sent directly to the boiler, although the temperature may need to be monitored to ensure complete combustion.

It has been shown that mixing biochar with manure or fertilizer can greatly enhance soil fertility, which will aid in plant, crop, or forest productivity without the use of CO₂-intensive fertilizers. The temperature of pyrolysis is of the utmost importance. If the temperature is too low, little gas is produced and the resulting char will have low surface area and thus is poorly suited to act as a soil amendment. If the temperature of pyrolysis is too high, not enough char is produced to adequately address carbon management. The duration of carbon sequestration in the soil is a topic of much debate and research, and will play an important role in the qualification of biochar as an acceptable sequestration strategy under CO₂ regulations.

Sequestering carbon using biochar is safe and may prove to be more economical than geological sequestration, although this approach is bound by restrictions. The most significant limitations to using biochar for CO₂ management from coal-based power plants are as follows:

- Availability of biomass material at inexpensive costs
- Acceptance of biochar as a suitable means of sequestration for carbon credits or trading

- Need for further research of overall cost benefits and soil amendment properties

Post-Combustion Capture

For the existing fleet, an important step in carbon capture and sequestration (CCS) is the separation of CO₂ from the other flue gases. Figure 2.5 shows the main components of a conventional coal-based power plant with the addition of a solvent or sorbent-based carbon capture system. In this figure, the solution or sorbent is used in a cyclic process. First, the material is sent through a contactor where it separates the CO₂ from the other flue gas constituents. Then, the CO₂-laden material is regenerated, usually through a change in temperature or pressure. The CO₂ gas is released in a nearly-pure stream and the CO₂-lean material is then used again to capture a new batch of CO₂. Due to the large volume of CO₂ to be captured, it is important that the material can be regenerated and used repeatedly.

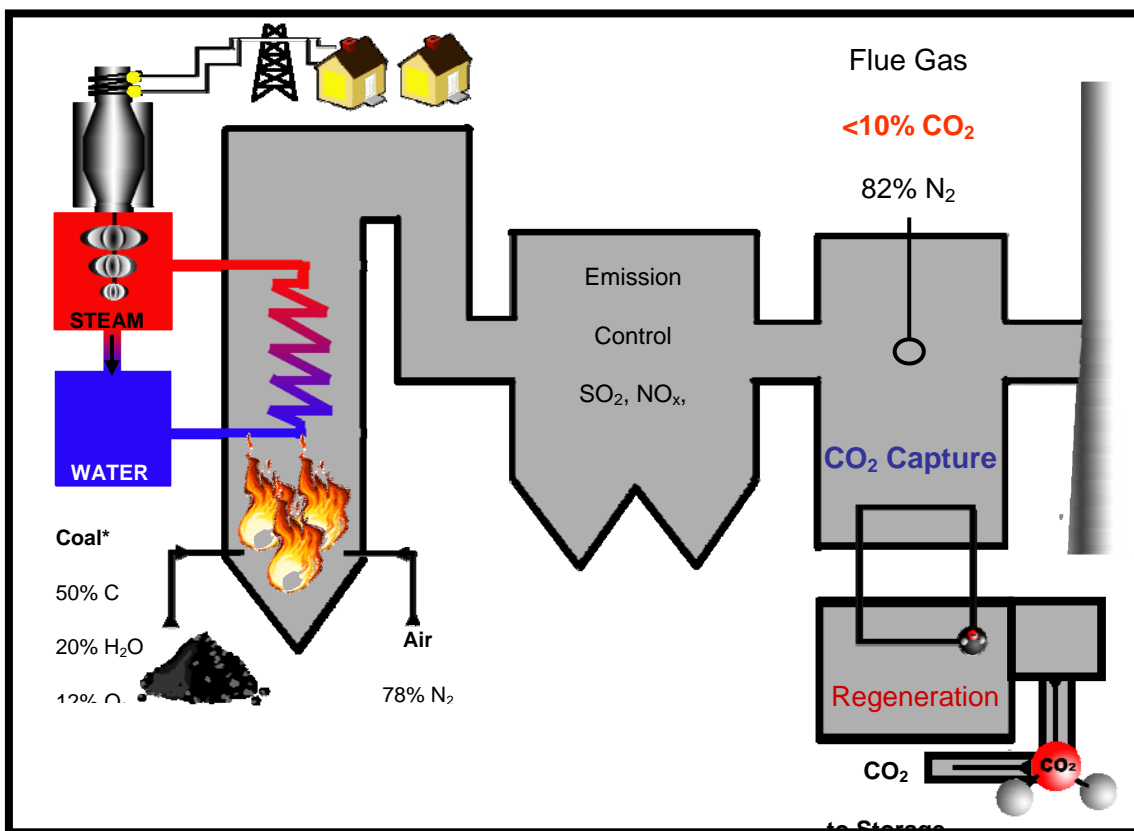

Figure 2.4. Conventional Coal-based Electric Station with Post-Combustion Carbon Capture

This section discusses the methods of separating (capturing) the CO₂ from flue gas for conventional coal-based power plants. Carbon capture technologies have the potential to remove nearly all the CO₂ from the flue gas. With adequate support, RD&D of this work can be accomplished quickly and efficiently.

- **Amine Scrubbers.** The post-combustion CO₂ capture processes being discussed for power plant boilers in the near-term draw upon commercial experience with amine

solvent separation at much smaller scale in the food, beverage and chemical industries, including three United States' applications of CO₂ capture from coal-based boilers. The amines are often viscous and corrosive and must be used in an aqueous solution.

These processes contact flue gas with an amine solvent in an absorber column much like a wet SO₂ scrubber. Here, the CO₂ chemically reacts with the solvent. However, successful CO₂ removal requires very low levels of SO₂ and NO₂ entering the CO₂ absorber, as these species also react with the solvent, requiring removal of the degraded solvent and replacement with fresh feed. Thus, high-efficiency SO₂ and NO_x control systems are essential to minimizing solvent consumption costs for post-combustion CO₂ capture; currently the approach to achieving such ultra-low SO₂ concentrations is to add a polishing scrubber, which is a costly venture. Using current technology, carbon capture utilizing MEA is expected to be prohibitively expensive. For example, a conventional power plant with 34.3 percent efficiency would be reduced to 25.1 percent efficiency due to the parasitic energy requirements of an MEA-based capture process. Extensive Research Development & Demonstration is in progress to improve system designs for power boiler applications and to develop better solvents with greater absorption capacity, less energy demand for regeneration, and greater ability to accommodate flue gas contaminants.

At present, monoethanolamine (MEA) is the “default” solvent for post-combustion CO₂ capture studies and small-scale field applications. Processes based on improved amines, such as Fluor's Econamine FG Plus and Mitsubishi Heavy Industries' KS-1, await demonstration at power boiler scale and on coal-derived flue gas. The potential for improving amine-based processes appears significant. For example, a recent study based on KS-1 suggests that its impact on net power output for a supercritical PC unit would be 19 percent and its impact on the levelized cost-of-electricity would be 44 percent; earlier studies based on suboptimal MEA applications yielded output penalties approaching 30 percent and cost-of-electricity penalties of up to 65 percent.

Using a mixture of amines, or a different solution can reduce the energy requirements. In fact, Mitsubishi Heavy Industries (MHI) is using a proprietary alkanolamine-based absorbent to capture CO₂ on a commercial scale and use it for chemical manufacturing. They have already begun using captured CO₂ as a feedstock for chemical manufacturing and are working toward economical CO₂ separation for enhanced oil recover and sequestration. Figure 2.6 shows the MHI processes for CO₂ capture.

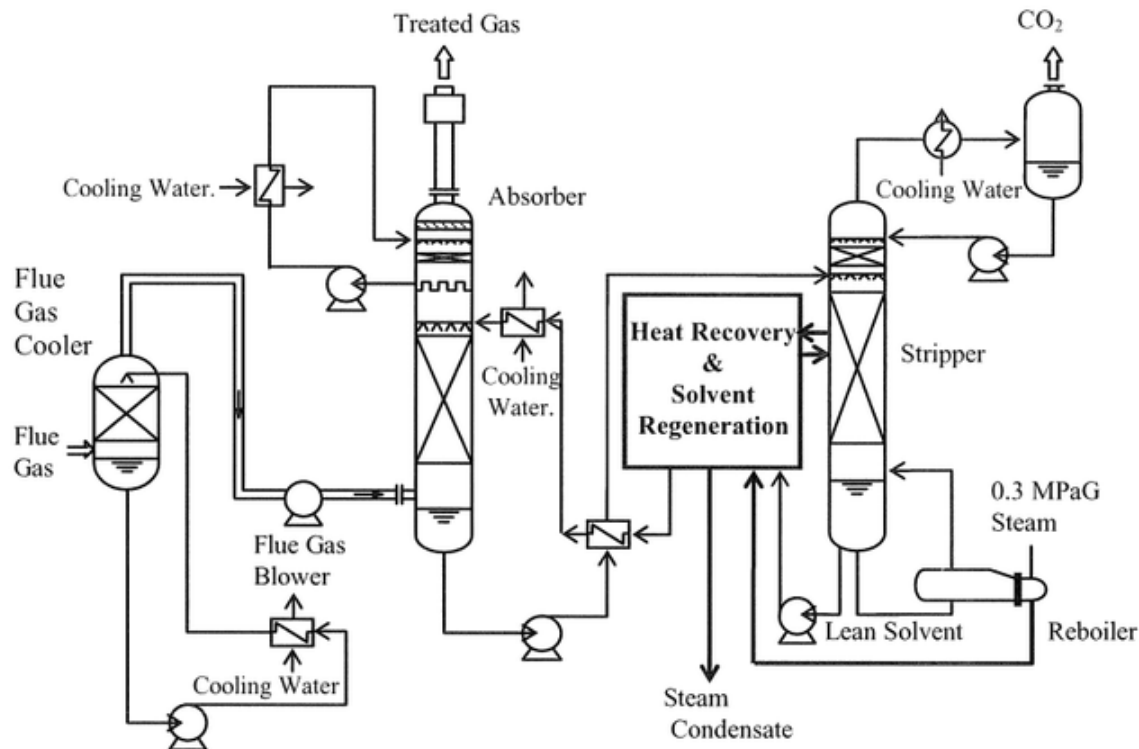

Figure 2.5. MHI Process for CO₂ Separation
Using a Proprietary Alkanolamine Solvent (Yagi et al., 2008)

- Ammonia-Based Systems.** When the challenges related to MEA-based capture became apparent, alternative solutions were considered. Ammonia-based liquid solvents are a promising technology for CO₂ separation. One challenge of using ammonia is the volatility; at high temperatures, the ammonia tends to be carried away with the CO₂-lean flue gas. This is addressed in two different manners. Either the flue gas is cooled (35-60°F) so that ammonia loss is negligible, or the evaporated ammonia can be recaptured in a process designed for multi-pollutant control.
 - Chilled Ammonia.** Alstom has developed their proprietary Chilled Ammonia process, where the volatility of the ammonia is reduced by chilling the flue gas to temperatures between 0-10°C (32-50°F). The flue gas flows counter-currently to a slurry containing ammonium carbonates and ammonium bicarbonates. The slurry is regenerated by heating to a temperature of >120°C (250°F). One advantage of this process is the ability to desorb the CO₂ at high pressure, >20 bar, reducing the energy requirements for compression.

Alstom has joined with American Electric Power (AEP) for large scale, two-phase testing and demonstration project. The first phase of testing will be completed at AEP's Mountaineer Plant, located in New Haven, on a 30 MWth slipstream. This test will use Alstom's process to capture up to 100,000 tons of CO₂ per year. This site has access to deep saline aquifers that will be used for sequestration of the

CO₂. This test is scheduled to start in late 2008 and is projected to continue for a period of 12 to 18 months. For the second phase of this project, Alstom will move to a 200 MW demonstration on a 450 MW unit at the Northeastern Station, located in Oologah, OK. The projected startup dates for this phase of demonstration is late 2011. If this second phase is successful, it will lead to an important commercial validation of a CO₂ capture technology that is projected to meet the DOE's <20% increase in the cost of electricity limit.

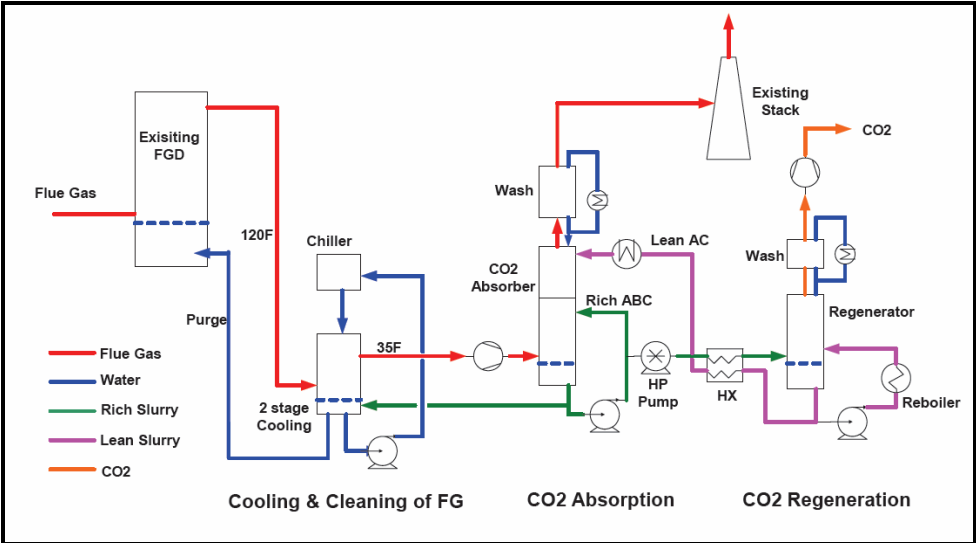

Figure 2.6. Schematic of Alstom's Chilled Ammonia Process (Alstom, 2007)

- **Multi-Pollutant Control with Ammonia Solutions.** Powerspan Corp.'s CO₂ capture process, called "ECO₂™," is being designed as an add-on system that could be deployed when needed; it is advantageous for sites where ammonia-based scrubbing of power plant emissions is employed.

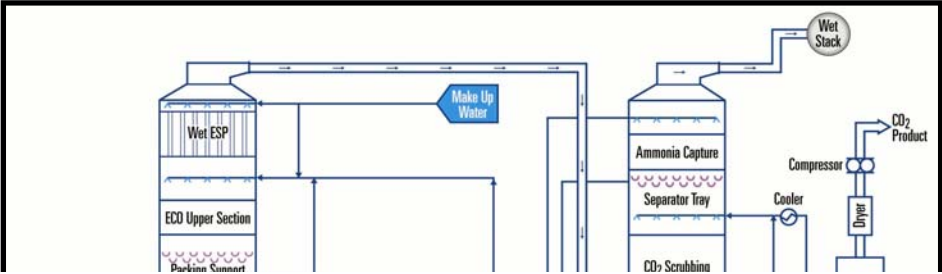
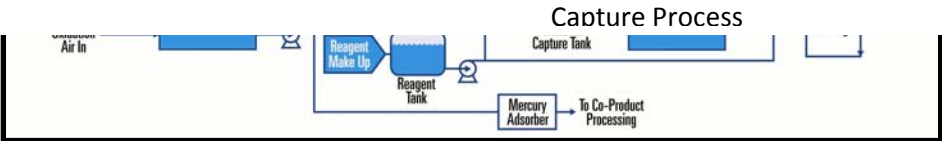

Figure 2.7. Incorporation of Powerspan's ECO₂™ CO₂



O₂ process is a thermal swing absorption (TSA) process for CO₂ capture. CO₂ absorption into the ammonia-based solvent takes place at low temperature. The solvent is then heated to release the CO₂. The process is similar to other CO₂ capture technologies such as amine-based processes. However, in the ECO₂ process, CO₂ in the flue gas is scrubbed with an aqueous solution containing ammonium carbonate, forming ammonium bicarbonate. CO₂ released by heating the solution is compressed for sequestration while the ammonium carbonate solution is returned to the scrubber for reuse.

The major advantage of using an ammonia-based scrubbing solution is the reduced energy of reactions when compared to amine-based CO₂ capture processes. This substantially reduces the energy consumption associated with solution regeneration. However, the use of ammonia requires control of ammonia vapor release to the flue gas during CO₂ scrubbing and to the product gas during solution regeneration. The ECO₂ process controls the ammonia release to the flue gas to less than 5 ppmv and recovers ammonia from the CO₂ product gas for reuse.

In November 2007, NRG Energy, Inc. and Powerspan announced their memorandum of understanding to commercially demonstrate the ECO₂ process at NRG's WA Parish plant near Sugar Land, Texas. The 125-megawatt (MW) equivalent CCS demonstration will be designed to capture and sequester about 1 million tons of CO₂ annually. The ECO₂ demonstration facility will be designed to capture 90 percent of incoming CO₂ and is expected to be operational in 2012. The captured CO₂ is expected to be used in enhanced oil recovery operations in the Houston area. In addition, in March 2008, Basin Electric Power Cooperative and Powerspan announced the selection of the ECO₂ process for a 120-MW commercial demonstration at Basin Electric's coal-based power plant, the Antelope Valley Station located near Beulah, North Dakota. The facility is expected to be operational in 2011. Both the NRG and the Basin Electric commercial demonstration projects are scheduled to move forward, subject to successful completion of engineering studies and obtaining of necessary permits and government incentives for early demonstrations of CO₂ capture and sequestration.

- **Dry Sorbents.** Solid sorbents are a promising CO₂ capture technology. Although carbon dioxide capture by solid sorbents has yet to be demonstrated on the scale necessary to reduce emissions from power plants, this is not a new technology. For years solid sorbents designed for CO₂ capture have been used to purify breathing air in confined spaces, such as space shuttles and submarines. There are different classifications of sorbents, such as chemical sorbents that react with the CO₂ and physical sorbents that adsorb the CO₂. Amines and other chemicals, such as sodium carbonate, can be immobilized on the surface of solid supports to create a sorbent that reacts with the CO₂. Solid sorbents that physisorb the CO₂ onto the surface include activated carbon, carbon nanotubes and zeolites (both natural and synthetic).

Physical sorbents can separate the CO₂ from the other flue gas constituents, but do not react with it. Instead, they usually provide a high surface area to which the CO₂ is drawn. These sorbents can be regenerated using a pressure swing or a temperature swing, although the costs associated with a pressure swing may be prohibitively high. Physisorbents such as activated carbon and zeolites will be safe for the local environment, and should be relatively inexpensive to manufacture.

Chemical sorbents that react with the CO₂ in the flue gas include a support, usually high surface area, with an immobilized amine or other reactant on the surface. The surface area allows for numerous sites for the desired reaction to occur. Examples of commonly used supports are alumina or silica, while common reactants include amines such as polyethylenimine (PEI) or sodium carbonate (Na₂CO₃).

Figure 2.9 shows the amount of CO₂ that a particular solid sorbent can hold at different temperatures and pressures, called adsorption isotherms. The blue line represents the CO₂ loading at the flue gas temperature, while the red line represents the CO₂ loading at higher temperature. Since the amount of CO₂ decreases at higher temperatures, heating up the sorbent will release the CO₂. After the CO₂ is released, it will be highly pure and can be used for sequestration. Using a change in temperature for capture/release cycles is often referred to as temperature swing adsorption (TSA).

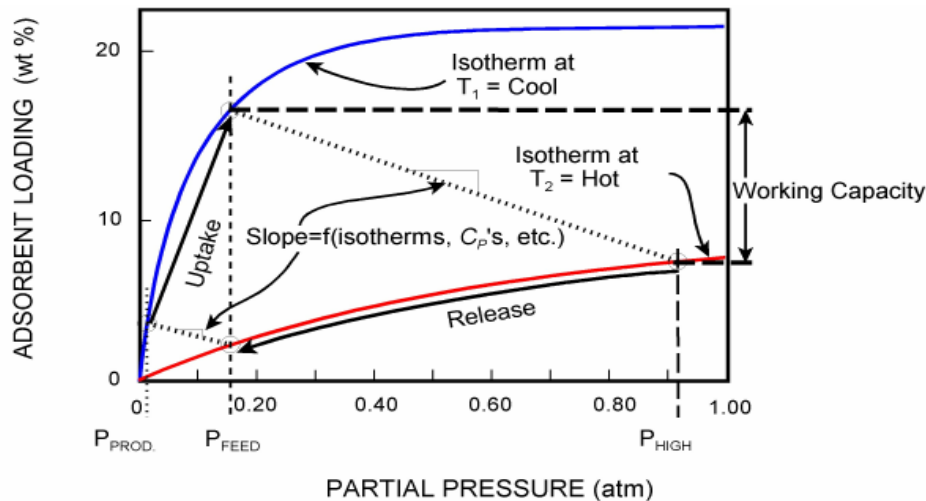

Figure 2. 8. Adsorption Isotherms for a CO₂ Sorbent

Potential advantages of solid sorbents are as follows:

- Ease of material handling (coal plants are experienced with solids handling)
- Safe for local environment

- High CO₂ capacity
 - Lower regeneration energy
 - Multi-pollutant control
- **Membranes.** Although still in the developmental stage, membranes have the potential to selectively separate CO₂ from flue gas. In the fuel and chemical industries, membranes are often used to separate CO₂ from light hydrocarbons. Ceramic and metallic membranes use their porous structure to sieve molecules by size.²⁰ Another type of membrane is being researched, called an absorption membrane; these membranes are impregnated with a liquid that selectively reacts with the CO₂. Separation using membranes is simple, with few moving parts.

Although current membranes are either not selective enough toward CO₂ -- i.e. the separated gas contains unacceptable concentrations of other flue gas constituents -- or not permeable enough to separate the CO₂, researchers may be able to improve membrane performance until it can be an economically feasible carbon capture technology.

Technology for separating CO₂ from shifted synthesis gas or flue gas from PC plants offers the promise of lower auxiliary power consumption but is currently only at the laboratory stage of development. Several organizations are pursuing different approaches to membrane-based applications. In general, however, CO₂ recovery on the low-pressure side of a selective membrane can take place at a higher pressure than is now possible with solvent processes, reducing the subsequent power demand for compressing CO₂ to a supercritical state. Membrane-based processes can also eliminate steam and power consumption for regenerating and pumping solvent, respectively, but they require power to create the pressure difference between the source gas and CO₂-rich sides. If membrane technology can be developed at scale to meet performance goals, it could enable up to a 50 percent reduction in capital cost and auxiliary power requirements relative to current CO₂ capture and compression technology.

- **Other Technologies for CO₂ Separation.** The need for alternative carbon capture technologies is great. There are several options that are in the early stages of research, as well as many unlikely to become financially competitive with the alternatives listed previously. For example, cryogenic distillation can readily separate CO₂ and N₂. Unfortunately, this process will not effectively separate the other emissions, such as SO₂ and NO_x, so it requires increased implementation of other emission control. In addition, it is believed that the energy requirements cannot be reduced enough to make cryogenic distillation competitive with other means of separating CO₂.

There are several other promising carbon capture technologies in the conceptual and early development stage, such as ionic liquids. With proper support, in the upcoming years these capture prospects will be tested and analyzed for feasibility. For CO₂ capture to be economical, a wide range of separation technologies must be utilized. Therefore, investing in new and ongoing research will play an important role in the success of CCS.

OPTIONS FOR NEW POWER PLANTS

Before the advent of CCS, some estimates project that there will be up to 45 GW of new, coal-based electricity generating capacity constructed in the United States (which is estimated as high as about 1000 gigawatts worldwide). According to NETL, 47 new plants with a combined capacity of 23 gigawatts are currently under construction, near construction, or permitted in the United States. The question arises: “What are the technology options for these new plants?” With new plants it is possible to incorporate the latest designs that maximize efficiency. It is also possible to consider new processes that convert coal to electrical power through gasification such as IGCC. These options are discussed below.

High Efficiency PC with Related Costs and Efficiencies for CCS

New PC plant can be designed for high efficiency, which will be important, due to the significant loss in capacity associated with CCS. Although some new technology will be necessary, ultra supercritical steam (USC) with steam parameters 4350 psi and 1112°F (300 bar and 600°C) have been in use in Japan and Europe since the 1990s. Present day SC and USC technologies, their efficiencies, CO₂ emission reductions, and the timeline for further developments are given in Table 2.2.

Technology	Maturity	Steam Parameters	Efficiency η (%) HHV
PC/SC	Mature	245 bar, 3x565°C (1050°F)	38.5%
PC/USC	In service today (Japan and Europe)	315 bar, 3x593°C (1100°F)	43.3%
PC/USC “THERMIE”	Post 2014 EU	380 bar, 3x700°C (1292°F)	46.4%
PC/USC DOE EPRI OCDO IND. CONS	Post 2020	385 bar, 3x760°C (1400°F)	48%

Table 2.1. Supercritical and Ultra Supercritical Plants, (Beer,2007; MIT,2007)

Comparative coal consumptions and CO₂ emissions of airblown coal combustion technologies are in Table 2.3.

	Existing Capacity Average	Subcritical	PC/SC	PC/US C	PC/USC “Thermie”	PC/USC DOE EPRI OCDO IND. CONS
Heat Rate (Btu/kW _e ·h)	10670	9950	8870	7880	7590	7480
Gen.	32.0%	34.3%	38.5%	43.3%	46.4%	48%

Efficiency (HHV)						
Coal Use (10⁶ t/yr)	1.660	1.549	1.378	1.221	1.150	1.145
CO₂ emitted (10⁶ t/y)	3.72	3.47	3.09	2.74	2.56	2.49
CO₂ emitted (g/kW_e·h)	998	931	830	738	690	670
CO₂ emitted (lbs/MW_e·h)	2196	2048	1826	1624	1518	1474
CO₂ Reductions vs. Existing Capacity	N/A	~7%	~17%	~26%	~31%	~33%

*Assumptions: 500 MW net plant output; Illinois #6 coal; 85% Capacity Factor

Table 2.2. Comparative Coal Combustions and Emissions of Airblown Pulverized Coal Combustion Technologies without CCS (Beer, 2007; MIT, 2007)

The primary factors associated with the addition of CCS to Subcritical Steam and Ultra Supercritical Steam plants are illustrated by Figures 2.10 and 2.11, respectively. The efficiency loss is approximately 9 percent.

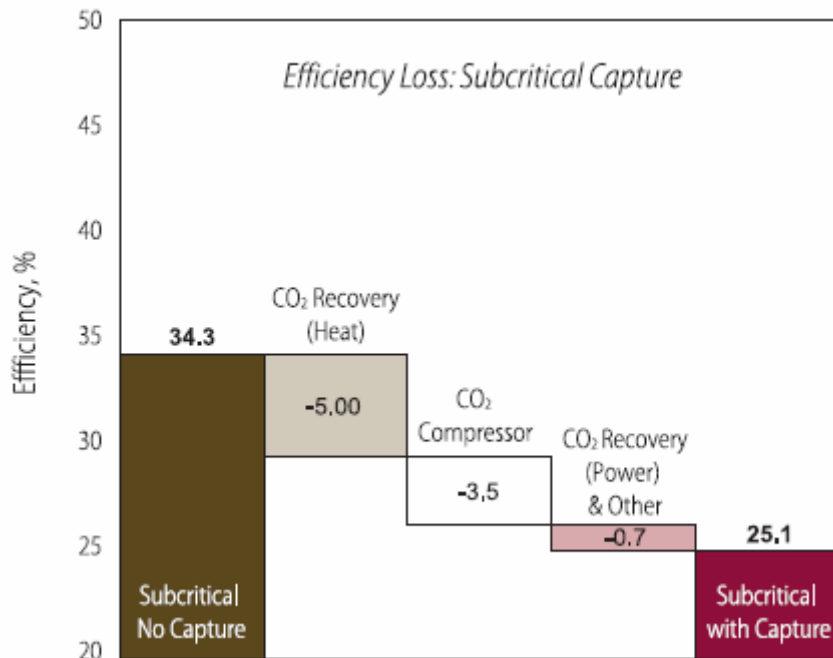

Figure 2.9. Parasitic Energy Requirements for a Subcritical PC Power Plant with Post-Combustion Capture (MIT, 2007)

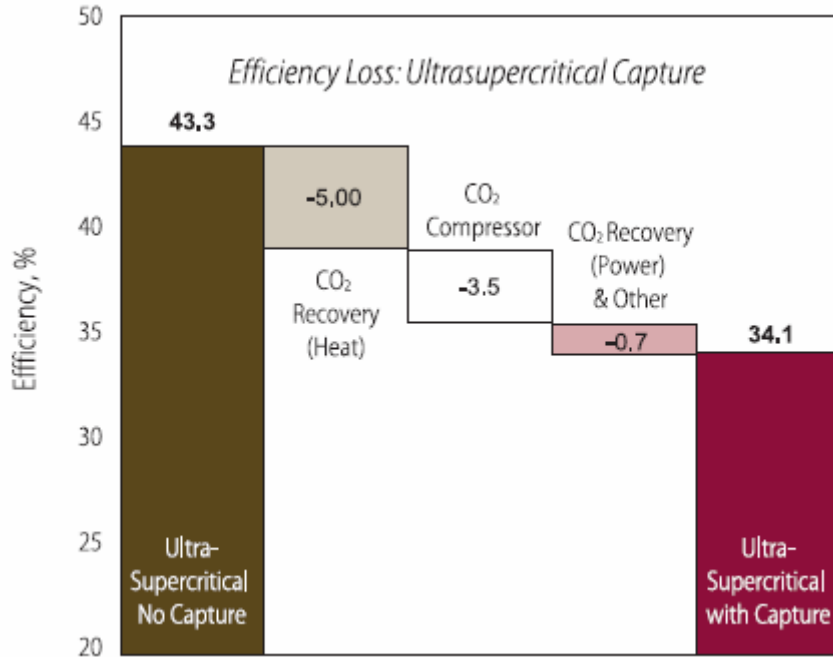

Figure 2.10. Parasitic Energy Requirements for an Ultra-Supercritical PC Power Plant with Post-Combustion Capture (MIT, 2007)

Figure 2.12 shows the main components of energy efficiency loss for pre-combustion capture.

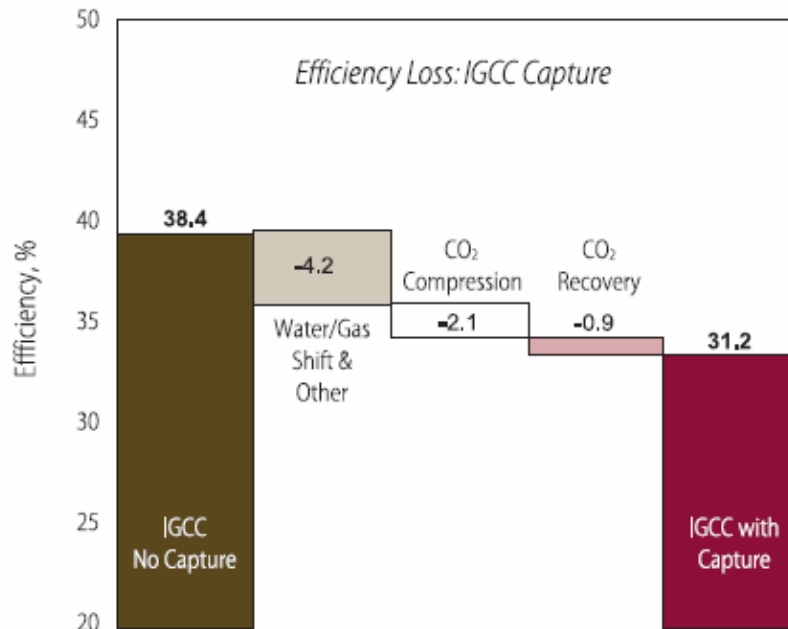

Figure 2.11. Parasitic Energy Requirement for IGCC with Pre-Combustion CO₂ Capture (MIT, 2007)

Economic indicators of various combustion technology options are shown in Table 2.4. While the capital costs of the more advanced plants are higher, the COE is getting gradually reduced as the plant efficiency increases, both without and with CO₂ capture.

	Subcritical		Supercritical		Ultra-supercritical		SC/Oxy
	Without	With	Without	With	Without	With	With
Eff. % (HHV)	34.3	25.1	38.5	29.3	43.3	34.1	30.6
CO₂ emitted (g/kW_e·h)	913	127	830	109	738	93.6	104
Total Cost Normalized by Subcritical PC Cost*	1	1.74	1.04	1.68	1.06	1.64	1.61
COE Normalized by Subcritical PC COE	1	1.68	0.99	1.59	0.97	1.52	1.42

*TCR for a PC subcritical plant is estimate to be \$1859/kW_e with construction cost increases of 30% that occurred since 2004 are included

**COE for a PC subcritical plant is estimated to be 5.57 c/kW_e·h

Table 2.3. CO₂ Emissions, Efficiency and Costs of Subcritical, Supercritical PC and SC/Oxy Without and With CCS (MIT, 2007)

A clear trade-off exists between operating efficiency and plant capital cost. However, the exact COE for different plants is a rapidly changing, often contested amount. Table 1.5 lists estimate COE from different plants

	IGCC Avg*	IGCC Avg*	Latest IGCC Project estimate AEP & Duke**	Pulverized Coal*			
				Subcritical		Supercritical	
Case	w/o CC	with CC		w/o CC	with CC	w/o CC	with CC
\$/kW	\$1,841	\$2,496	\$4,000	\$1,474	\$2,626	\$1,508	\$2,635
LCOE, Cents/kWh*	7.79	10.63		6.40	11.88	6.33	11.48
% Increase in		36.4			85.6		81.4

COE with Capture							
------------------	--	--	--	--	--	--	--

* Average of 3 IGCC designs (GE, CoP E-Gas, Shell), “Cost and Performance Baseline for Fossil Energy Plants,” Exhibit ES-2, DOE, May 2007. CO₂ transport, storage and monitoring adds <0.5 ¢/kWh, increase in COE ~ 3 cents/kWh (36%)

** Based on latest IGCC estimates, see 9/10/07 *Power Daily*, page 5, for Duke \$2.0 billion estimate and 6/18/07 \$2.23 billion filing of AEP's 629 MW W. Virginia plant

Table 2.4. Cost Estimates for Different Types of Plants (Beer, 2007; MIT, 2007)

Figure 2.13 shows this relationship for the following three plants: PC subcritical, PC supercritical and IGCC. As the efficiency increases, the plant capital cost also increases. However, when CCS is implemented at each of the respective plants, the cost-to-efficiency relationship is notably different. With the addition of CCS, the more efficient plants become less expensive. Figure 2.14 shows the cost and efficiency of the different power plants with CCS. Both Figure 2.13 and 2.14 have been normalized by the capital cost and efficiency of a PC subcritical coal- based power plant (PC Subcritical Estimates: Capital Cost = \$1548/kW (\$2007) and Efficiency = 36.8 percent HHV).

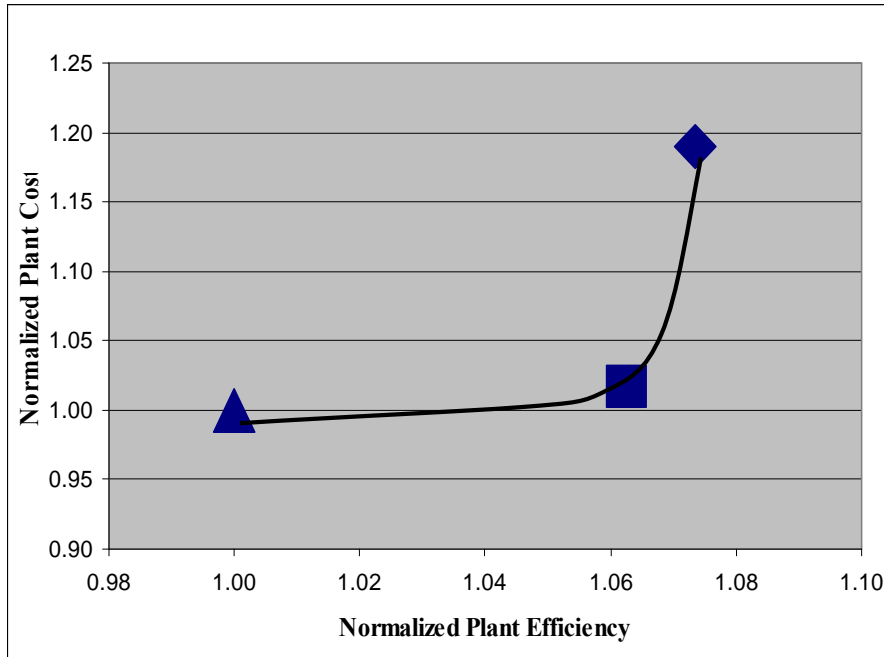

Figure 2.12. Relationship Between Plant Capital Cost and Plant Efficiency without CCS Normalized by the Values for a Subcritical PC Plant ▲ PC Subcritical, ■ PC Supercritical, ◆ IGCC

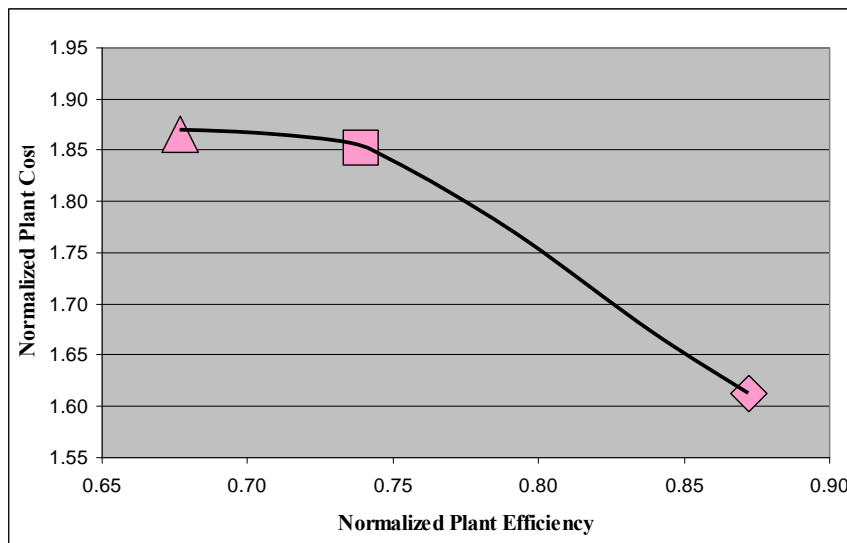





Figure 2.13. Relationship Between Plant Capital Cost and Plant Efficiency with CCS Normalized

by the Values for a Subcritical PC Plant  PC Subcritical,
 PC Supercritical,  IGCC

New plants should be built with the highest economically justifiable efficiency both for their period of operation without CCS, and also to be able to carry the burden of efficiency reduction when equipped with CO₂ capture in the future. R&D in progress to develop alternative, reduced energy-intensity capture processes, such as the chilled ammonia process deserve high priority. Research needs of post-combustion cleanup processes are discussed in more detail later in this chapter.

The Gasification of Coal

Introduction to Integrated Gasification Combined Cycle

The integrated gasification combined cycle (IGCC) technology has significant environmental advantages. The gas is burned in a gas turbine providing thermal efficiency in the range of 38 percent to 42 percent HHV. The turbine technology and combined cycle process offers additional opportunities to increase this efficiency even higher while allowing separation of the carbon stream at high pressure for sequestration and carbon management.

There appear to be two gasification markets these days — an international coal-to-chemicals market often stated as industrial gasification and a coal-to-power IGCC market that is represented mostly by the U.S. applications. The majority of the announced new coal IGCC plants are in the United States. Others include demonstrations in Japan and Korea, several planned projects in Europe and some recently announced in China. There are non-coal IGCC systems as well, mostly for poly-generation and the use of refinery residuals. The United States has long been the leader in coal-to-power gasification.

The typical block flow diagram in Figure 2.15 illustrates the basic systems common to most IGCC power plant designs. It contains a listing of the basic systems and major components. Major components are contained in two groupings, commonly referred to as the “power island” and the “gasification island.” Typically, the capacity of the gasification system is selected to match the fuel needs of the combustion turbine, along with design decisions regarding spare gasification capacity, which may be used to increase plant availability or to allow supplemental firing to increase steam production for the steam turbine or process use.

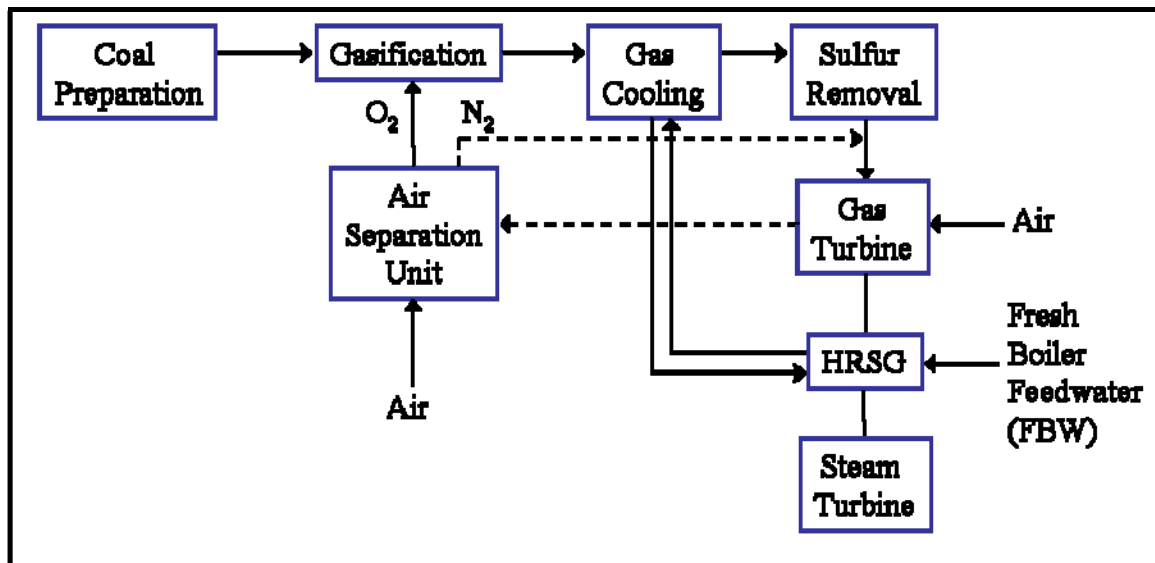

Figure 2.14. Typical Block Flow Diagram for IGCC

IGCC plant configurations used as “baseline designs” for economic comparisons employ two GE 7FA gas turbines, each capable of producing 197 megawatts of power when fired on SNG. These turbines are incorporated in a combined cycle configuration with a single steam turbine-generator. The net plant output is approximately 520 megawatts.

The baseline plant may have either a dry-fed gasifier or slurry-fed gasifier and may be oxygen-blown or air-blown. IGCC plants with oxygen-blown gasifiers have an air separation unit (ASU) with two 50 percent trains. A portion of the air for the ASU -- usually 25 to 50 percent supplied by extraction from the GT compressors, reducing compression costs. The baseline IGCC designs do not include a spare gasifier.

IGCC with Carbon Capture

IGCC technology allows for CO₂ capture to take place via an added fuel gas processing step at elevated pressure, rather than at the atmospheric pressure of post-combustion flue gas, permitting capital savings through smaller equipment sizes and lower operating costs.

Currently available technologies for such pre-combustion CO₂ removal employ a chemical and or physical solvent that selectively absorbs CO₂ and other “acid gases,” such as hydrogen sulfide. Application of this technology requires that the CO in synthesis gas, the principal component,

first be “shifted” to CO₂ and hydrogen, via a catalytic reaction with water. The CO₂ in the shifted synthesis gas is then removed via contact with the solvent in an absorber column, leaving a hydrogen-rich synthesis gas for combustion in the gas turbine. The CO₂ is released from the solvent in a regeneration process that typically reduces pressure and or increases temperature.

The impact of current pre-combustion CO₂ removal processes on IGCC plant thermal efficiency and capital cost is significant. In particular, the water-gas shift reaction reduces the heating value of synthesis gas fed to the gas turbine. Because the gasifier outlet ratios of CO to methane to H₂ are different for each gasifier technology, the relative impact of the water-gas shift reactor process also varies. In general, however, it can be on the order of a 10 percent fuel energy reduction. Heat regeneration of solvents further reduces the steam available for power generation. Other solvents, which are depressurized to release captured CO₂, must be re-pressurized for reuse. Cooling water consumption is increased for solvents needing cooling after regeneration and for pre-cooling and interstage cooling during compression of separated CO₂ to a supercritical state for transportation and storage. Heat integration with other IGCC cycle processes to minimize these energy impacts is complex and is currently the subject of considerable Research and Development & Demonstration by EPRI and others.

Relative Cost and Efficiency of IGCC Plants

A contractor for the National Energy Technology Center in 2007 generated cost and efficiency data on coal-based and natural gas fired plants. Figure 2.16 pictorially depicts net plant efficiency (HHV) for PC, SC, IGCC and NGCC plants with no carbon capture and sequestration (CCS) and with appropriate CCS. The efficiency of a supercritical plant without CCS is shown comparable to an average IGCC, (39.1 percent to 39.5 percent). However, when CCS is added to a supercritical plant, the net efficiency is shown to drop by approximately 2 more percentage points than the loss in efficiency observed for an IGCC plant with the addition of CCS.

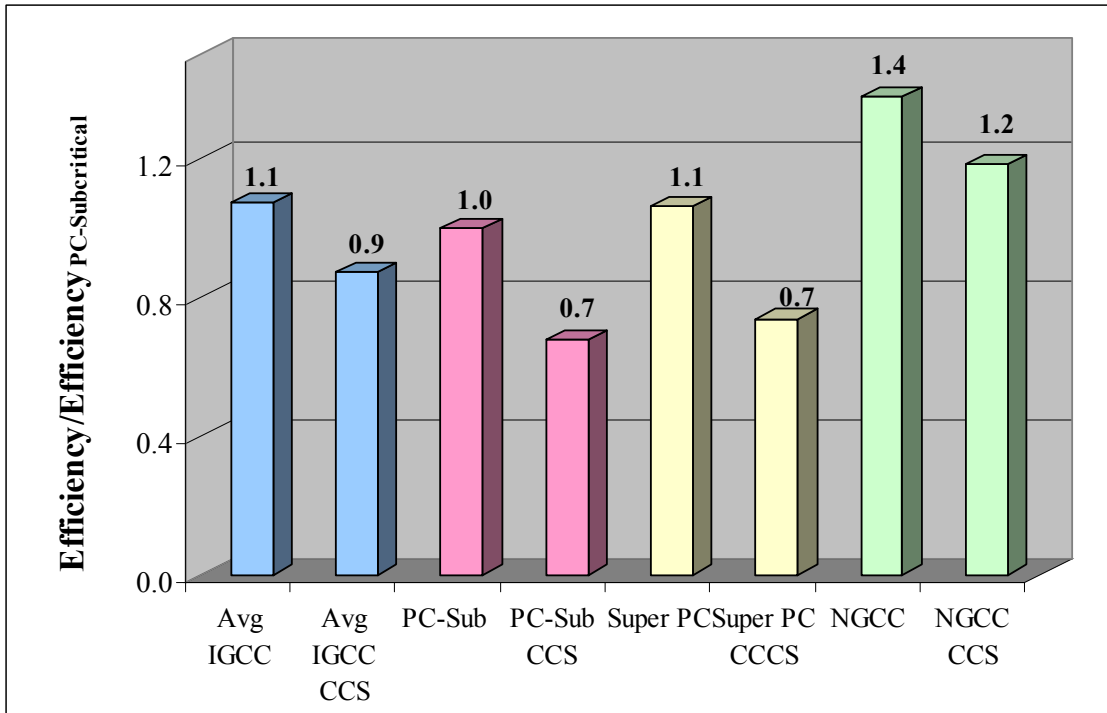

Figure 2.15. Net Plant Efficiency With and Without CCS Normalized by the Net Efficiency for a PC Subcritical Plant (36.8% HHV Basis)

The DOE contractor included the super-critical plants for comparison. If the ultra super-critical plants were also included, the efficiency without CCS could be up to 43.5 percent. However, like the sub-critical plant, this efficiency would be reduced by approximately 9 percent to 34.1 percent.

A comparison of total plant cost for the same types of power plants is presented in Figure 2.17. The cost is non-dimensionalized by the cost of a subcritical PC (also see Tables 2.4 and 2.5). Previously, the cost of an average IGCC plant cost without CCS was estimated to be approximately \$1,841 versus \$1,574 for a supercritical plant. when the CCS feature is added, the total plant cost for an average IGCC plant increases to approximately \$2496 compared to \$2,868 for a supercritical plant. Note that it is likely that actual costs would be higher due to the recent increases in construction, etc.

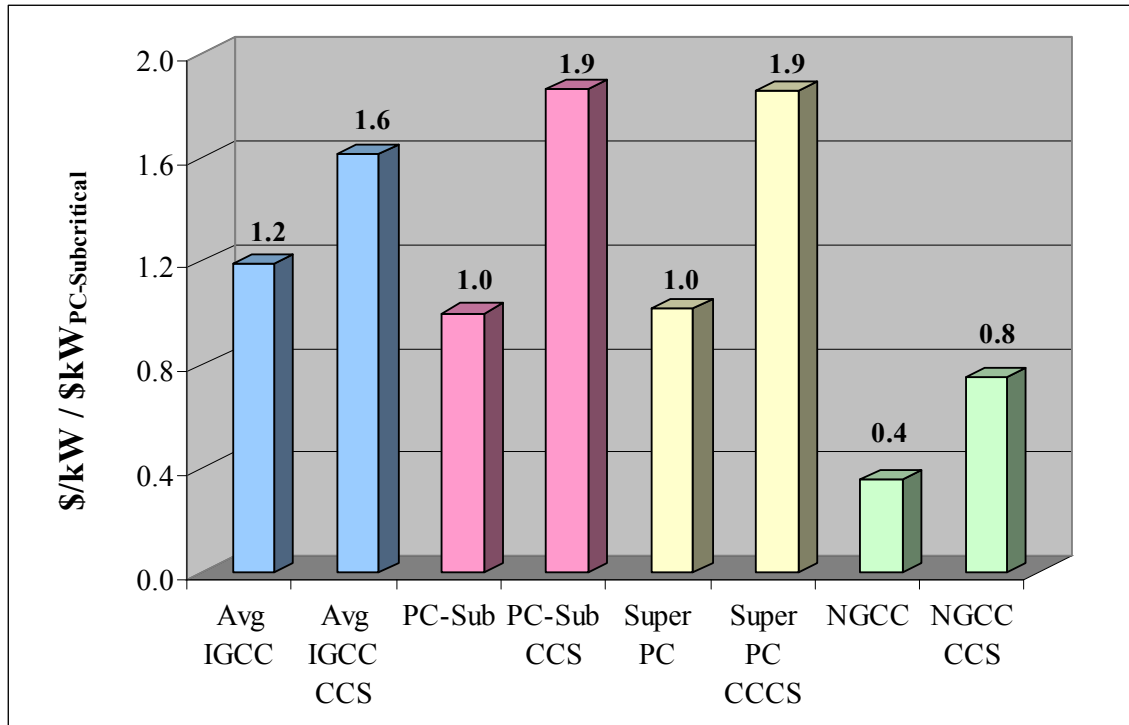

Figure 2.16. Total Plant Cost With and Without CCS Normalized by the Plant Cost for a PC Subcritical Plant

In the Gasification Technology Conference of October 2007, the speakers emphasized that the IGCC availability must be increased to be competitive with the estimated supercritical plants. It was mentioned that the IGCC plants in the United States seem to have a lower availability than those being operated in Europe.

- Fuel Cells and IGCC.** No matter how far gasification and turbine technologies advance, IGCC power plant efficiency will never progress beyond the inherent thermodynamic limits of the gas turbine and steam turbine power cycles along with lower limits imposed by available materials technology. Several IGCC fuel cell hybrid power plant concepts (IGFC) aim to provide a path to coal-based power generation with net efficiencies that exceed those of conventional combined cycle generation.

Along with its high thermal efficiency, the fuel cell hybrid cycle reduces the energy consumption for CO₂ capture. The anode section of the fuel cell produces a stream that is highly concentrated in CO₂. After removal of water, this stream can be compressed for sequestration. The concentrated CO₂ stream is produced without having to include a water-gas shift reactor in the process (see Figure 2.18). This further improves the thermal efficiency and decreases capital cost. IGFC power systems are a long-term solution, however, and are unlikely to see full-scale demonstration until about 2030.

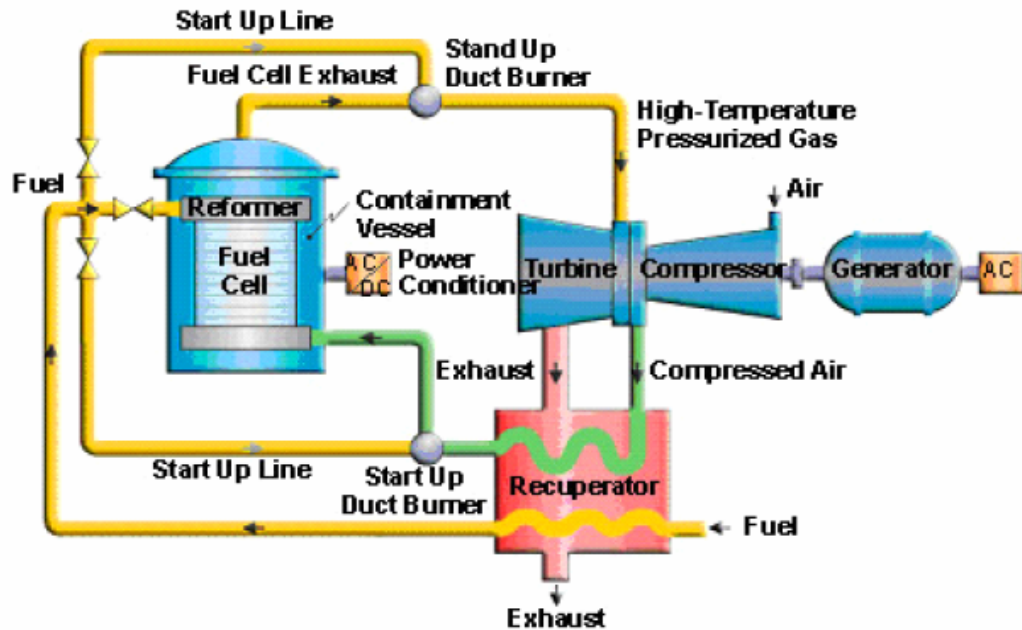

Figure 2.17. Schematic of Fuel Cell-Turbine Hybrid (USDOE,2008)

Gasification of Biomass with Coal

The partial replacement of coal with waste and biomass materials for gasification can be a way of reducing carbon intensity. In a number of countries, this is regarded as being of significant environmental benefit, and government subsidies and other incentives are available to encourage these activities. The coal can be regarded as being beneficial because the security of supply of a number of the waste and biomass materials is uncertain, and the quality of the delivered fuel is subject to only limited control. These are significant risk areas in most waste/biomass energy conversion projects, and the co-utilization of coal can be regarded as providing a means of reducing these risks, in that the supply of coal to a prescribed quality specification is assured.

Although biomass-based generation is assumed to yield no net emissions of CO₂ because of the sequestration of biomass during the planting cycle, there are environmental impacts. Wood contains sulfur and nitrogen, which yield SO₂ and NO_x in the combustion process. However, the rate of emissions is significantly lower than that of coal-based generation. For example, per kilowatt hour generated, biomass integrated gasification combined-cycle (generating plants can significantly reduce particulate emissions by a factor of 4.5 in comparison with coal-based electricity generation processes. NO_x emissions can be reduced by a factor of about 6 for dedicated BIGCC plants compared with average pulverized coal-based plants.

The technology of co-gasification can result in very clean power plants using a range of fuels but there are considerable economic and environmental challenges. Waste materials may attract significant disposal credits. Cleaner biomass materials are renewable fuels and may attract premium prices for the electricity generated.

Availability of sufficient fuel locally for an economic plant size is often a major issue, as is the reliability of the fuel supply. Use of more predictably available coal alongside these fuels

overcomes some of these difficulties and risks. Coal could be regarded as the “flywheel” which keeps the plant running when the fuels producing the better revenue streams are not available in sufficient quantities. Coal characteristics are very different to younger hydrocarbon fuels such as biomass and wastes. Hydrogen-to-carbon ratios are higher for younger fuels, as is the oxygen content. This means that their reactivities are very different under gasification conditions. Gas cleaning issues can also be very different, with sulfur a major concern for coal gasification but chlorine compounds and tars more important for waste and biomass gasification.

Advanced Turbines Program for High Efficiency and Carbon Sequestration

Global emphasis on clean energy generation, including containment of greenhouse gas emissions prompted several industrial and government initiatives worldwide. Various options for clean power generation with appropriate provisions for carbon capture and sequestration are being examined by the United States Government and industry. Increasing plant efficiency and improving cost of electricity through higher availability are the most appealing alternatives. After a comprehensive internal assessment, the DOE announced sponsorship of several advanced turbine programs for utility turbine applications. These include the oxy-fuel turbine, the hydrogen turbine program, and the low swirl combustion system initiative.

Oxy-Fuel Turbines

The oxy-fuel system operation in its simple form is a near-zero emission process that has been developed for power generation by adapting an aerospace rocket technology for the ‘oxy combustor.’ The combustor must demonstrate the capability to burn gaseous fuel in combination with oxygen and water. Fuels combusted include SNG from coal. The combustion takes place at near-stoichiometric conditions in the presence of recycled water to produce a steam/CO₂ mixture at high temperature and pressure. The combustor exhaust then enters either a steam turbine or a modified gas turbine operating at high temperatures. The gas exiting the turbines enters a condenser/separator where it is cooled, separating into its components, water and CO₂. The recovered CO₂ is conditioned and purified as appropriate and transmitted for enhanced oil recovery or sequestered. Most of the water is recycled to the gas generator but excess high-purity water is produced and available for export.

The combustor and re-heater are in the development phase. A lab scale combustor was operated at temperatures of up to 1,482°C and pressures up to 300 psia. The combustor operated on O₂, CH₄, and water. It demonstrated operation with varying temperatures and pressures. The combustor operated successfully at both low power, (20 percent of rated power and full power.



Advanced Coal-Based Cycle

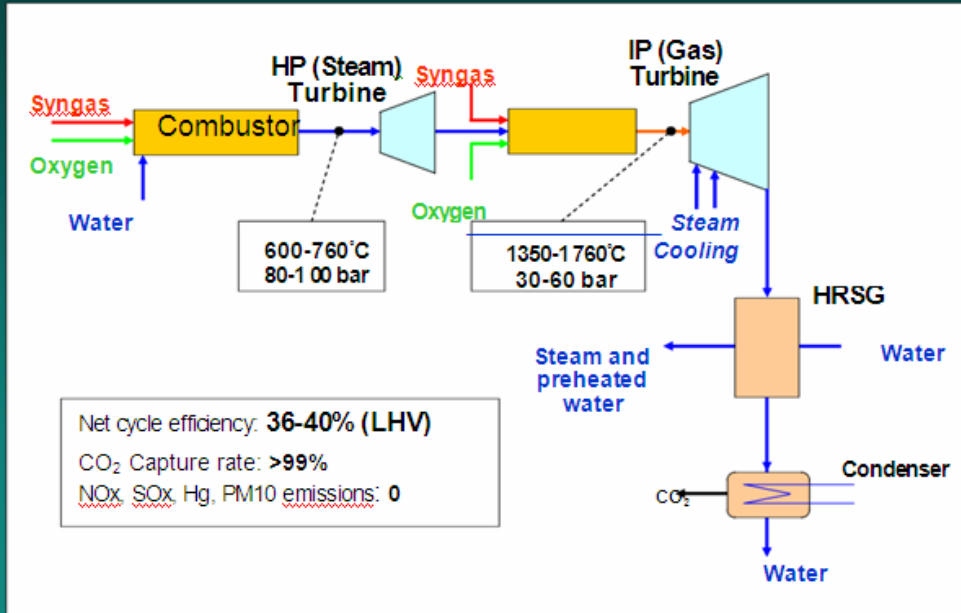

Figure 2.18. Proposed Oxy Fuel Turbine System Configuration

One proposed approach is to use oxy-fuel combustion for ultra high temperature and high pressure turbines using steam and CO₂ mixture as working fluid and demonstrate by 2015 capture of >99% CO₂ and achieve system efficiency of approximately 50 percent.

On a near-term basis, further analysis and testing of the oxy-fuel combustor process are required to determine suitability of this process with hydrogen-depleted SNG. The combustor should be tested at a gasification facility to demonstrate operation on actual SNG.

Hydrogen Turbines

The primary objective of this project is to develop the technology for a fuel flexible coal-derived hydrogen and SNG gas turbine that achieves these key performance goals:

- Efficiency (45-50 percent combined cycle efficiency)
- Emissions (less than 2 ppm NO_x at 15% O₂)
- Capital cost (less than \$1,000/kW in 2003 dollars)

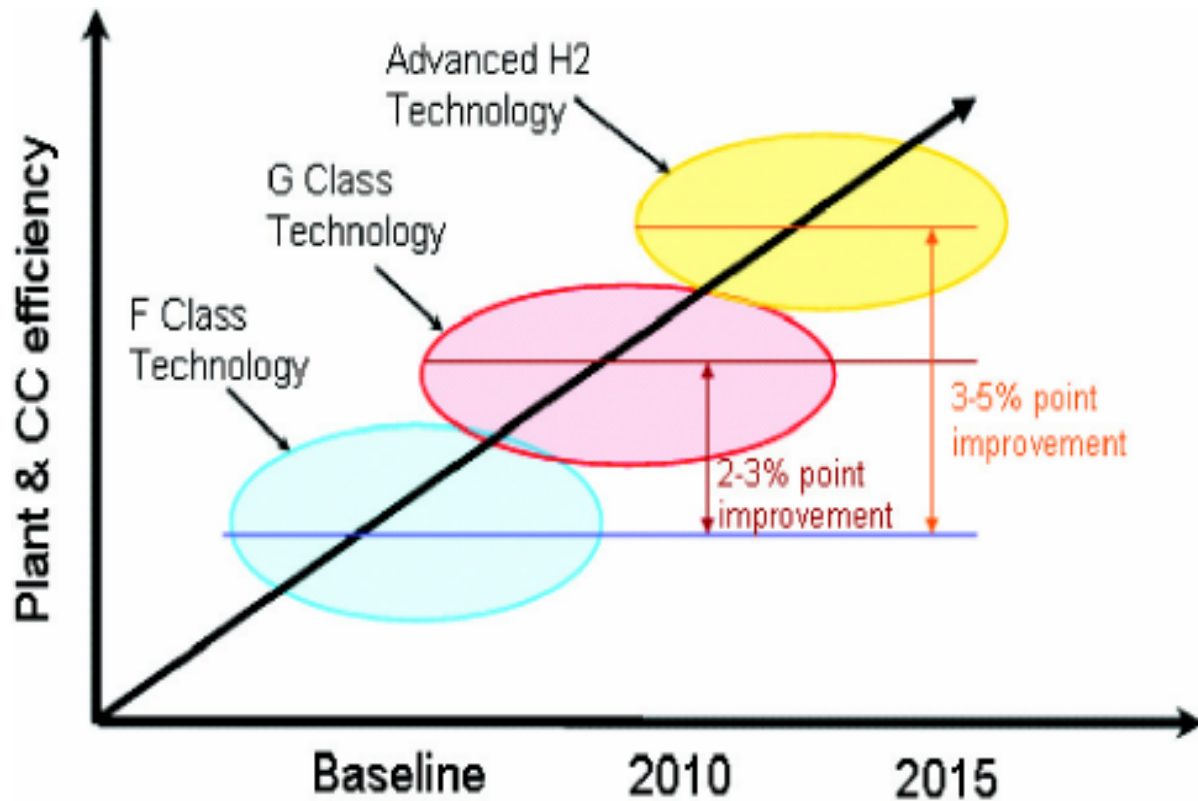

Figure 2.19. Advanced Hydrogen Turbine Project Efficiency Goals

Currently concepts and preliminary designs of advanced hydrogen turbines on a DOE contract have been completed. These turbines will utilize coal-based SNG stream of hydrogen.

Low-Swirl Combustion (LSC) Turbines

The objective of this project is to adapt lean, premixed, low swirl combustion to the gas turbines in integrated gasification combined cycle (IGCC) clean coal power plants that burn coal-derived SNG and hydrogen. This project utilizes the low swirl combustion technology of Lawrence Berkeley National Laboratory. Current plans are to evaluate this technology at gas turbine operating conditions in F class utility turbines operating on SNG derived hydrogen fuels.

This project is focused on developing a cost-effective and robust combustion system for advanced gas turbines in IGCC power plants that burn hydrogen-rich SNG or pure hydrogen derived from coal gasification. The DLN combustion technologies developed for burning natural gas may not be readily adaptable to the fast burning and dynamic characteristics of hydrogen flames. These systems involve relatively costly and complex remedies that can impact the system operation of the IGCC power plant. The LBNL developed simple lean premixed low swirl combustion technology shows very good promise for resolving the combustion issues on burning H₂ in gas turbines.

Turbulent flame speed is central to the LSC concept. Lifted flame exemplifies propagating nature of premixed combustion. Correlation of turbulent flame speed, ST, with turbulence intensity

provides empirical constant for the LSC analytical model. The floating flame burner does not overheat. The LSC is adaptable to wide operating conditions, it is fuel-flexible (all gaseous fuels).

The development of low-swirl combustion is viewed as an enabling technology in IGCC power plants utilizing high H₂ fuels. The system has been tested in an industrial turbine which, at operating conditions produced 4 < 5 ppm NO_x at 15% O₂.

Collaborations with OEMs have been initiated to identify and begin to address engine compatibility, scale-up, and system integration issues. Future work is focused on verifying the analytical model for H₂ flames at gas turbine conditions and to develop computational design tools. Other studies include gaining insights into the H₂ specific combustion phenomena such as the thermal-diffusive effects, flashback, flame ejection, and auto-ignition to optimize the LSI and its components.

CARBON COMPRESSION

Conventional Methods of Compression

For retrofit and new plants capturing CO₂ for geological sequestration, compression of the CO₂ is an important component of the process. The pressure of the CO₂ downstream of the regeneration step will determine the energy requirements necessary for CO₂ compression. For most cases, the compression step will be a multistage process that transforms gaseous CO₂ at a pressure of approximately 1 atm (15 psia) to a supercritical liquid at 73 atm (1070 psia).

For a 500 MW_e subcritical PC unit with 90 percent CO₂ capture using an amine-based system, compression of the CO₂ can consume as much as 70 MW_e. This additional internal energy consumption requires 76,000 kg/hr of additional coal (above the no-capture case of 284,000 kg/hr coal), a 14 percent increase over the no-capture case to produce the same net electricity. All associated equipment is also effectively 14 percent larger. Design and operating experience, and optimization could be expected to reduce this somewhat, as could new technology.

Another study developed a specific approach to the compression step, shown in Figure 2.21, based on an MEA capture system. The compression system includes an initial compression stage followed by cooling and moisture knockout. Then, a pump is used to convert the CO₂ into a supercritical fluid. For this system to be used in a 500 MW plant with 90 percent CO₂ compression would require nearly 7 percent of the plant's power output, or 34,845 kW. However, the cost of compression is expected to decrease with continuing evaluation of optimal integration and operation studies, as well as the advent of more efficient, novel compression systems and schemes.

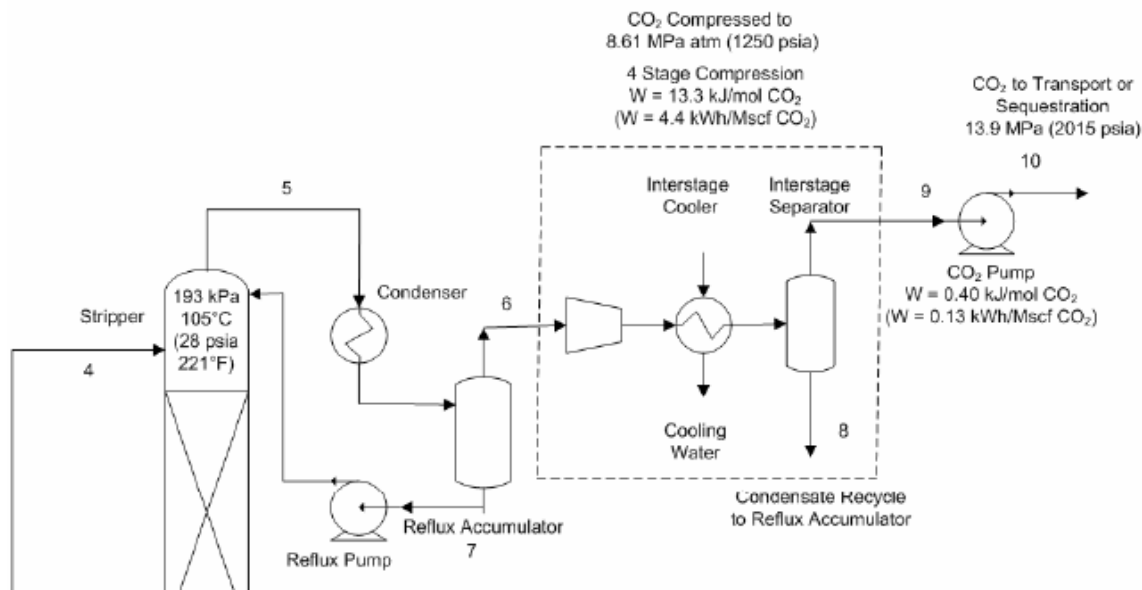

Figure 2.20. Base Case Compression Configuration (Fisher et.al., 2005)

The CO₂ from the amine unit is compressed in a single train to 8.6 MPa (1250 psia) and then pumped with multistage centrifugal pumps to 13.9 MPa (2015 psia) pipeline pressure. The efficiency for this type of pump is 60 percent.

The total CO₂ capture flow rate for the 500 MW base case is approximately 2,025 m³/min (71,500 acfm). For this size range, either a small axial compressor or a large centrifugal compressor could be used (according to compressor selection guidance in the Gas Processors Suppliers Association manuals). Axial compressors are expected to be similar in cost to centrifugals and may even be somewhat higher since they are not as widely used in industry. The efficiency of an axial compressor is approximately the same as that of a multistage centrifugal compressor (79.5 percent polytrophic efficiency) for this application. Given the lack of any apparent cost or efficiency advantages, and the complexities of maintaining and operating different compressor types with differing maintenance schedules, centrifugal compressors were used in all of the cases.

The CO₂ compression at the power plant may need to be supplemented due to losses during pipeline transportation. One estimate assumed the compression and transport of CO₂ emissions from a 500 MW power plant would require a 34 MW compressor plant. The example limited transport to 62 miles to eliminate the need for a booster station. Booster stations will be required every 100 to 200 miles to maintain pressure; significant parasitic power from the booster stations and safety become important issues for long-distance compressed CO₂ transport. Several companies are conducting RD&D efforts to help increase the efficiency and reduce the cost in compression. Some of this research is being funded by the DOE.

Novel Methods of Compression

The compression of CO₂ using conventional means requires significant compression power to boost the pressure to typical pipeline levels. The penalty can be as high as 8% to 12 percent for a typical IGCC plant. For a project funded by the National Energy Technology Laboratory (NETL) within the Department of Energy (DOE) and with co-funding provided by Dresser-Rand, Southwest Research Institute (SwRI) has investigated novel methods to minimize this penalty through novel compression concepts.

For gaseous compression, the project seeks to develop improved methods to compress CO₂ while removing the heat of compression internal to the compressor. The high pressure ratio compression of CO₂ results in significant heat of compression. Because less energy is required to boost the pressure of a cool gas, both upstream and inter-stage cooling are desirable. This project has determined the optimum compressor configuration and has developed technology for internal heat removal. Other concepts that liquefy the CO₂ and boost pressure through cryogenic pumping have been explored as well.

BENEFICIAL USE OF CAPTURED CO₂

The key task of much ongoing research, development, and demonstration is to find technologies to economically separate CO₂ from flue gas and then compress it. In most cases, it is expected that the CO₂ will be stored long term in geological formations or injected into oil reservoirs to boost tertiary oil production, called Enhanced Oil Recovery (EOR). CO₂ separated from coal-based plants may be utilized for EOR in oil producing regions where natural CO₂ sources and infrastructure are not available. Although underground injection will play an important role in CO₂ emissions control for many coal-based power plants, it will not be a viable option for others. For power plants too far from suitable sequestration sites, alternatives to CCS will be necessary.

Ideally, CO₂ that cannot be sequestered geologically can be used for beneficial purposes. For example, because plants use CO₂ during photosynthesis, increased concentration of this gas can accelerate crop growth in large greenhouses, provided sufficient sunlight and water are also available. Similarly, growth of algae can also be accelerated by enrichment of CO₂. Because coal-based power plants have high concentrations of CO₂ in the flue gas and are distributed geographically to areas with adequate water and solar insolation, they are ideally suited to host large-scale production of algae to produce biofuels. Since the algae is grown in large ponds or bio-reactors, it has significantly less environmental impact compared to traditional biofuels, such as ethanol from corn. Researchers are currently working to identify the best algal strains for this use. Biofuels from algae grown on coal-based flue gas have the potential to make a significant impact not only on CO₂ emissions, but on the energy security of the United States.

Captured CO₂ from coal-based flue gas may also be chemically recycled to produce liquid fuels that could be used as a petro-chemical feedstock. One example of such a process is conversion to methanol that can then be stored, transported as a liquid fuel, used as a fuel in fuel cells or employed as a starting point for synthetic hydrocarbons. There are several paths to convert CO₂ to methanol, one of which is through catalytic reaction with hydrogen. The hydrogen can come from multiple sources, such as disassociation of water, which is an inexhaustible resource. The

combination of dimethyl ether and methanol can be blended with gasoline for transportation or electricity production. When the fuel produced from algae or methanol is burned it will inevitably release CO₂. However, because the CO₂ for algae growth and methanol production originated from power plant flue gas and the liquid fuel or synthetic hydrocarbons produced replace fossil petroleum, the net impact on CO₂ emissions is quite dramatic.

Other proposed and emerging applications use carbon dioxide as a starting material for fertilizer production or various building materials. Given the potential surplus of useful, purified carbon dioxide through carbon capture, these and other CO₂ recycling options should be developed as alternatives or supplements to sequestration. In order for CO₂ recycling to become reality, large volumes of purified CO₂ must be economically available. Coal-based power plants without access to suitable sequestration sites have the potential to supply the purified gas for varied beneficial uses, with further development support and the advancement of carbon capture technologies.

CARBON OFFSETS FROM USE OF COAL COMBUSTION BYPRODUCTS

The production of coal combustion products (CCP) like fly ash, bottom ash, flue gas desulfurization materials, and other CCPs is a process that will continue as long a coal is used to generate electricity. Coal fly ash is the CCP that is produced in the largest quantities annually in the United States. In 2006 approximately 72,400,000 tons of fly ash were produced by electric utilities. Of that amount, more than 15 million tons were used in concrete and concrete products. The use of fly ash in concrete is a sustainable success story for many reasons.

Mixing cement (the glue), aggregates, fines, and water forms concrete. Fly ash contributes to sustainability because the manufacture of portland cement creates about a ton of CO₂ for each ton of cement produced. In general terms, contractors can prevent the release of a ton of CO₂ by using fly ash in cement feedstock. One can replace a portion of the cement in concrete with fly ash and achieve needed performance requirements. In 2006, more than 15 million tons of CO₂ were avoided by the use of fly ash.

Another way to measure fly ash's environmental benefit is by the energy saved. One ton of fly ash saves the equivalent energy needed to provide electricity to the average home for 24 hours. Even more important to future generations is water savings. Concrete containing fly ash requires less water than ordinary Portland cement concrete. The United States consumes more than 400 million yards of concrete annually. Fly ash concrete allows for a water reduction of 2 to 10% over normal concrete. Therefore, between 200 million and a trillion gallons of water could be saved annually by including fly ash in concrete mixes.

Because fly ash makes concrete more durable, i.e. less permeable and more resistance to adverse conditions, structures made with concrete will not need to be replaced as frequently as other buildings. In life cycle analyses, concrete shows definite advantages over asphalt (in roadways) and wood (in buildings), lowering the overall cost. Using high-volume fly ash mixes will offset the need for additional cement and may actually delay the construction of new cement kilns because some of the demand for cement can be met by fly ash.

RD&D FUNDING NEEDS

Developing the suite of technologies needed to achieve competitive advanced coal and CCS technologies will require a sustained major investment in Research Development & Demonstration. As shown in Table 2.6, EPRI estimates that an expenditure of approximately \$8 billion will be required in the 10-year period from 2008 to 2017. The MIT *Future of Coal* report estimates the funding need at up to \$800 to \$850 million per year, which approaches the EPRI value. Further, EPRI expects that an RD&D investment of roughly \$17 billion will be required over the next 25 years.

	2008–12	2013–17	2018–22	2023–27	2028–32
Total Estimated RD&D Funding Needs (Public + Private Sectors)	\$830M/yr	\$800M/yr	\$800M/yr	\$620M/yr	\$400M/yr

Table 2.5. RD&D Funding Needs for Advanced Coal Power Generation Technologies with CO₂ Capture (MIT, 2007)

In addition, five to 15 full-scale sequestration projects, funded through a public/private partnership, may also be necessary to prove this component of CCS. Similar to the estimated COE from different plants, the amount actually needed for RD&D is also a matter of debate, and has likely increased from the numbers given in Table 2.6. By any measure, these estimated RD&D investments are substantial. EPRI and the members of the *CoalFleet for Tomorrow*[®] program believe that by promoting collaborative ventures among industry stakeholders and governments the costs of developing critical path technologies for advanced coal and CCS can be shouldered by multiple participants. EPRI believes that government policy and incentives will also play a key role in fostering CCS technologies through early RD&D stages to achieve widespread, economically feasible deployment capable of achieving major reductions in CO₂ emissions.

RD&D Timelines

A typical path to develop a technology to commercial maturity consists of moving from the conceptual stage to laboratory testing to small pilot-scale tests, to larger-scale tests, to multiple full-scale demonstrations, and finally to deployment in full-scale commercial operations. For capital-intensive technologies such as advanced coal power systems, each stage can take years or even a decade to complete, and each sequential stage entails increasing levels of investment. As depicted in Figure 2.22, several key advanced coal power and CCS technologies are now in or approaching the “development” stage. This is a time of particular vulnerability in the technology development cycle; it is common for the expected costs of full-scale application to be higher than earlier estimates when less was known about scale-up and application challenges. Public agency and private funders can become disillusioned with a technology development effort, but as long as fundamental technology performance results continue to meet expectations, and a path to cost reduction is clear, perseverance by project sponsors in maintaining momentum is crucial.

Unexpectedly high costs at the mid-stage of technology development have historically come down following market introduction, experience gained from “learning-by-doing,” realization of

economies of scale in design, and production as order volumes rise, and removal of contingencies covering uncertainties and first-of-a-kind costs. The International Energy Agency study led by Carnegie Mellon University (CMU) observed this pattern of cost-reduction-over-time for power plant environmental controls, and CMU predicts a similar reduction in the cost of power plant CO₂ capture technologies as the cumulative installed capacity grows. EPRI concurs with their expectations of experience-based cost reductions and believes that RD&D on specifically identified technology refinements can lead to cost reductions sooner in the deployment phase.

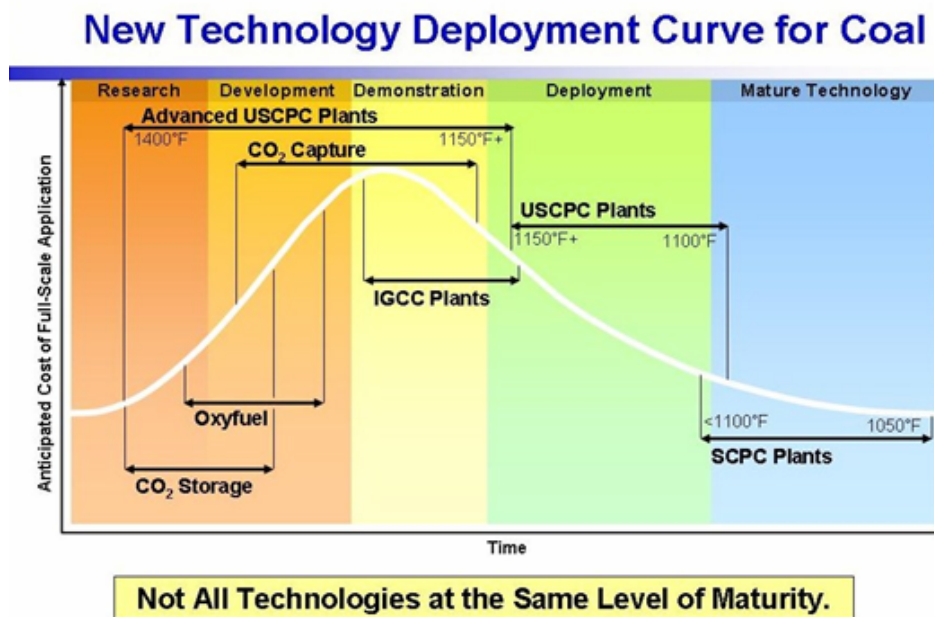

Note: Temperatures shown for pulverized coal technologies are turbine inlet steam temperatures

Figure 2.21. Model of the development status of major advanced coal and CO₂ capture and storage technologies (Hannegan ,2007)

It is crucial that other technologies in the portfolio — namely ultra-supercritical (USC) PC, integrated gasification combined cycle (IGCC), CO₂ capture (pre-combustion, post-combustion, and oxycombustion), and CO₂ storage—be given sufficient support to reach the stage of declining constant dollar costs *before* society’s requirements for greenhouse gas reductions compel their application in large numbers.

Improving Efficiency of Existing Plants

With an aggressive Research Development & Demonstration program on efficiency improvement, new ultra-supercritical (USC PC) plants could reduce CO₂ emissions per MWh by up to 25 percent relative to the existing fleet average. Significant efficiency gains are also

possible for IGCC plants by employing advanced gas turbines and through more energy-efficient oxygen plants and synthesis (fuel) gas cleanup technologies.

EPRI and the Coal Utilization Research Council (CURC), in consultation with DOE, have identified a challenging but achievable set of milestones for improvements in the efficiency, cost, and emissions of PC and coal-based IGCC plants. The EPRI-CURC Roadmap projects an overall improvement in the thermal efficiency of state-of-the-art generating technology from 38 to 41 percent in 2010 to 44 to 49 percent by 2025 (on a higher heating value [HHV] basis. As Tables 2.4 and 2.5 indicate, power-block efficiency gains (i.e., without capture systems) will be offset by the energy required for CO₂ capture, but as noted, they are important in reducing the overall cost of CCS. Coupled with opportunities for major improvements in the energy efficiency of CO₂ capture processes per se, an aggressive pursuit of the EPRI-CURC RD&D program offers the possibility of coal power plants with CO₂ capture by 2025—plants that have net efficiencies meeting or exceeding current-day power plants without CO₂ capture.

It is also important to note that the numeric ranges in Table 2.7 are not simply a reflection of uncertainty, but rather they underscore an important point about differences among U.S. coals. The natural variations in moisture and ash content and combustion characteristics between coals have a significant impact on attainable efficiency. An advanced coal plant using Wyoming and Montana’s Powder River Basin (PRB) coal for example would likely have an HHV efficiency two percentage points lower than the efficiency of a comparable plant using Appalachian bituminous coals. Equally advanced plants using lignite would likely have efficiencies two percentage points lower than their counterparts firing PRB.

Any government incentive program with an efficiency-based qualification criterion should recognize these inherent differences in the attainable efficiencies for plants using different ranks of coal.

	2010	2015	2020	2025
PC & IGCC Systems (Without CO ₂ Capture)	38–41% HHV	39–43% HHV	42–46% HHV	44–49% HHV
PC & IGCC Systems (With CO ₂ Capture*)	31–32% HHV	31–35% HHV	33–39% HHV	39–46% HHV

*Efficiency values reflect impact of 90% CO₂ capture, but not compression or transportation.

Table 2.6. Efficiency Milestones in EPRI-CURC Roadmap (Hannegan ,2007)

Improving CO₂ Capture Technologies

CCS entails pre-combustion or post-combustion CO₂ capture technologies, CO₂ drying and compression and sometimes further removal of impurities, and the transportation of separated CO₂ to locations where it can be stored away from the atmosphere for centuries or longer.

Albeit at considerable cost, CO₂ capture technologies can be integrated into all coal-based power plant technologies. For both new plants and retrofits, there is a tremendous need (and opportunity) to reduce the energy required to remove CO₂ from fuel gas or flue gas. Figure 2.23 shows a selection of the key technology developments and test programs needed to achieve commercial CO₂ capture technologies for advanced coal combustion- and gasification-based power plants at a progressively shrinking constant-dollar leveled cost-of-electricity premium. Specifically, the target is a premium of about \$6/MWh in 2025 (relative to plants at that time without capture) compared with an estimated 2010 cost premium of perhaps \$40/MWh (not including the cost of transportation and storage). Such a goal poses substantial engineering challenges and will require major investments in Research Development & Demonstration to roughly halve the currently large energy requirements (operating costs) associated with CO₂ solvent regeneration. Achieving this goal will allow power producers to meet the public demand for stable electricity prices while reducing CO₂ emissions to address climate change concerns.

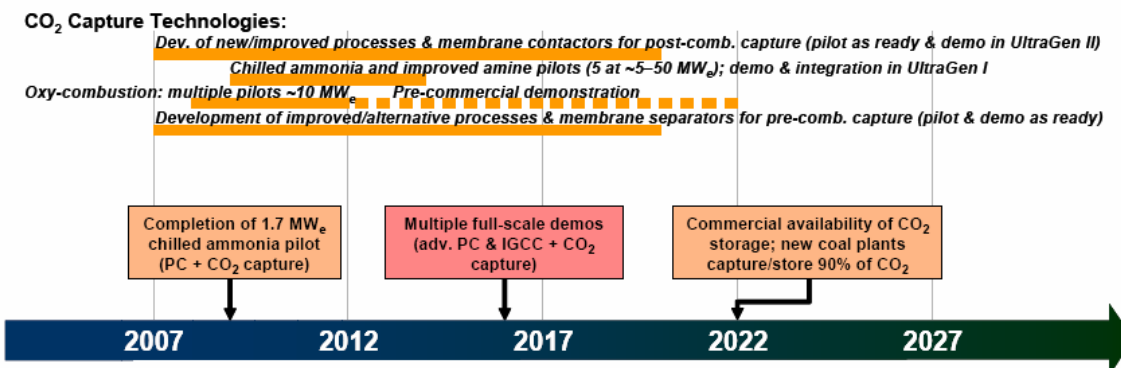

Figure 2.22. Timing of CO₂ Capture Technology Development RD&D Activities and Milestones (Hannegan ,2007)

New Plant Efficiency Improvements—Advanced Pulverized Coal

Current state-of-the-art plants use supercritical main steam conditions (i.e., temperature and pressure above the “critical point” where the liquid and vapor phases of water are indistinguishable). SCPC plants typically have main steam conditions up to 1100°F. The term “ultra-supercritical” is used to describe plants with main steam temperatures in excess of 1100°F and potentially as high as 1400°F.

Achieving higher steam temperatures and higher efficiency will require the development of new corrosion-resistant, high-temperature nickel alloys for use in the boiler and steam turbine. In the United States, these challenges are being addressed by the Ultra-Supercritical Materials Consortium, a DOE R&D program involving Energy Industries of Ohio, EPRI, the Ohio Coal

Development Office, and numerous equipment suppliers. EPRI provides technical management for the consortium. Results are applicable to all ranks of coal. As noted, higher power block efficiencies translate to lower costs for post-combustion CO₂ capture equipment.

It is expected that a USC PC plant operating at about 1300°F will be built during the next seven to ten years, following the demonstration and commercial availability of advanced materials from these programs. This plant would achieve an efficiency (before installation of CO₂ capture equipment) of about 45 percent (HHV) on bituminous coal, compared with 39 percent for a current state-of-the-art plant, and would reduce CO₂ production per net MWh by about 15 percent. Ultimately, nickel-based alloys are expected to enable stream temperatures in the neighborhood of 1400°F and pre-capture generating efficiencies up to 47 percent HHV with bituminous coal. This approximately 10 percent improvement over the efficiency of a new subcritical pulverized-coal plant would equate to a decrease of about 25 percent in CO₂ and other emissions per MWh. The resulting saving in the cost of subsequently installed CO₂ capture equipment is substantial.

Figure 2.24 illustrates a timeline developed by EPRI’s *CoalFleet for Tomorrow*® program to establish efficiency improvement and cost reduction goals for USC PC plants with CO₂ capture.

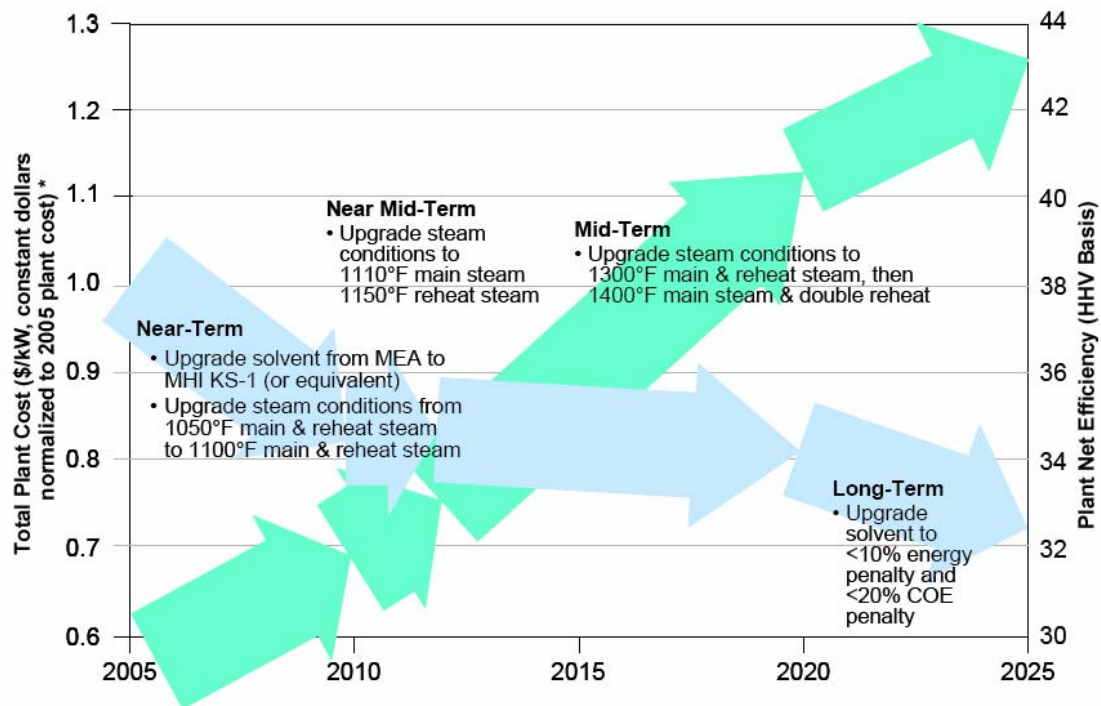

* For a unit designed for 90% unit availability and 90% post-combustion CO₂ capture firing a Pittsburgh #8 bituminous coal; cost normalization using Chemical Engineering Plant Cost Index or equivalent. A similar trend is observed in analyses of PC units with CCS using other United States’ coals, although the efficiency values are up to two percentage points lower for units firing sub-bituminous coal such as Powder River Basin and up to four percentage points lower for units firing lignite. (Hannegan, 2007)

Figure 2.23. RD&D Path for Capital Cost Reduction (Falling Arrows) and Efficiency Improvement (Rising Arrows) for PC Power Plants with 90%

EPRI and industry representatives have proposed a program to support commercial projects that demonstrate advanced PC and CCS technologies. The vision entails construction of two (or more) commercially operated USC PC power plants that combine state-of-the-art pollution controls, ultra-supercritical steam power cycles, and innovative CO₂ capture technologies.

The UltraGen I plant will use the best of today's proven ferritic steels in high-temperature boiler and steam turbine components, while UltraGen II will be the first plant in the United States to feature nickel-based alloys that are able to withstand the higher temperatures of advanced ultra-supercritical steam conditions.

UltraGen I will demonstrate CO₂ capture modules that separate about 1 million tons CO₂ per year using the best established technology. This system will be about six times the size of the largest CO₂ capture system operating on a coal-based boiler today. UltraGen II will double the size of the UltraGen I CO₂ capture system, and may demonstrate a new class of chemical solvent if one of the emerging low-regeneration energy processes has reached a sufficient stage of development. Both plants will demonstrate ultra-low emissions. Both UltraGen demonstration plants will dry and compress the captured CO₂ for long-term geologic storage and or use in enhanced oil or gas recovery operations.

To provide a platform for testing and developing emerging PC and CCS technologies, the UltraGen program will allow for technology trials at existing sites, as well as at the sites of new projects. EPRI expects the UltraGen projects will be commercially dispatched by electricity grid operators. The differential cost to the host company for demonstrating these improved features are envisioned to be offset by any available tax credits (or other incentives) and by funds raised through an industry-led consortium formed by EPRI.

The UltraGen projects represent the type of "giant step" collaborative efforts that need to be taken to advance integrated PC/CCS technology to the next phase of evolution and assure competitiveness in a carbon-constrained world. Because of the time and expense for each "design and build" iteration for coal power plants (three to five years not including the permitting process and ~\$2 billion), there is no room for hesitation in terms of commitment to advanced technology validation and demonstration projects.

The UltraGen projects will resolve technical and economic barriers to the deployment of USC PC and CCS technology by providing a shared-risk vehicle for testing and validating high-temperature materials, components, and designs in plants also providing superior environmental performance.

Figure 2.25 summarizes EPRI's recommended major RD&D activities for improving the efficiency and cost of USC PC technologies with CO₂ capture.

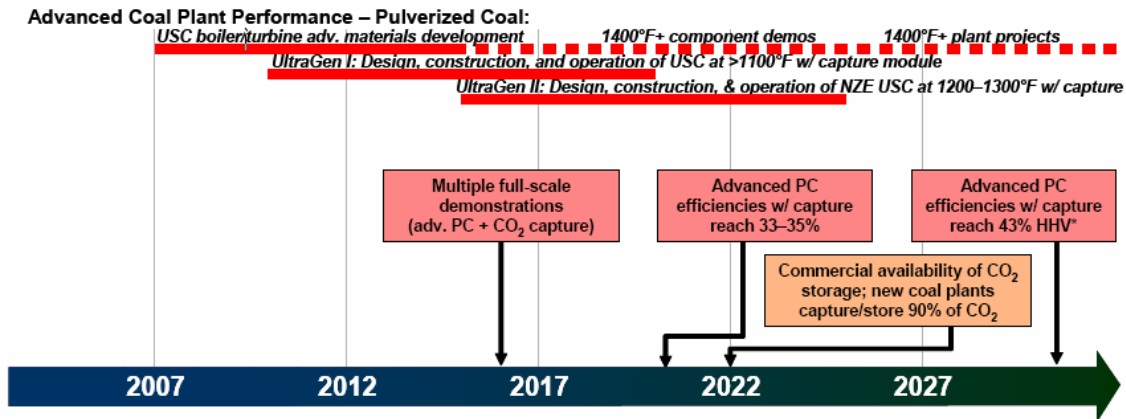

*for bituminous coal; equally advanced PC plants firing subbituminous coal and lignite will have efficiencies two to four percentage points lower due to higher moisture and ash contents

Figure 2.24. Timing of Advanced PC and CO₂ Capture Integration RD&D Activities and Milestones (Hannegan, 2007)

New Plants—Improving IGCC

Although IGCC is not yet a mature technology for coal-based power plants, chemical plants around the world have accumulated a 100-year experience operating coal-based gasification units and related gas cleanup processes. The most advanced of these units are similar to the front end of a modern IGCC facility. Similarly, several decades of experience firing natural gas and petroleum distillate have established a high level of maturity for the basic combined cycle generating technology. Nonetheless, ongoing RD&D continues to provide significant advances in the base technologies, as well as in the suite of technologies used to integrate them into an IGCC generating facility.

Efficiency gains in currently proposed IGCC plants will come from the use of new “FB-class” gas turbines, which will provide an overall plant efficiency gain of about 0.6 percentage point (relative to IGCC units with FA-class models, such as Tampa Electric’s Polk Power Station). This corresponds to a decrease in the rate of CO₂ emissions per MWh of about 1.5 percent. Alternatively, this means 1.5 percent less fuel is required per MWh of output, and thus the required size of pre-combustion water-gas shift and CO₂ separation equipment would be slightly smaller.

Figure 2.26 depicts the anticipated timeframe for further developments identified by EPRI’s *CoalFleet for Tomorrow*® program that promise a succession of significant improvements in IGCC unit efficiency. Key technology advances under development include:

- larger capacity gasifiers (often via higher operating pressures that boost throughput without a commensurate increase in vessel size)
- integration of new gasifiers with larger, more efficient G- and H-class gas turbines
- use of ion transport membrane or other more energy-efficient technologies in oxygen plants

- warm synthesis gas cleanup and membrane separation processes for CO₂ capture that reduce energy losses in these areas
- recycle of liquefied CO₂ to replace water in gasifier feed slurry (reducing heat loss to water evaporation)
- hybrid combined cycles using fuel cells to achieve generating efficiencies exceeding those of conventional combined cycle technology

Improvements in gasifier reliability and in control systems also contribute to improved annual average efficiency by minimizing the number and duration of startups and shutdowns.

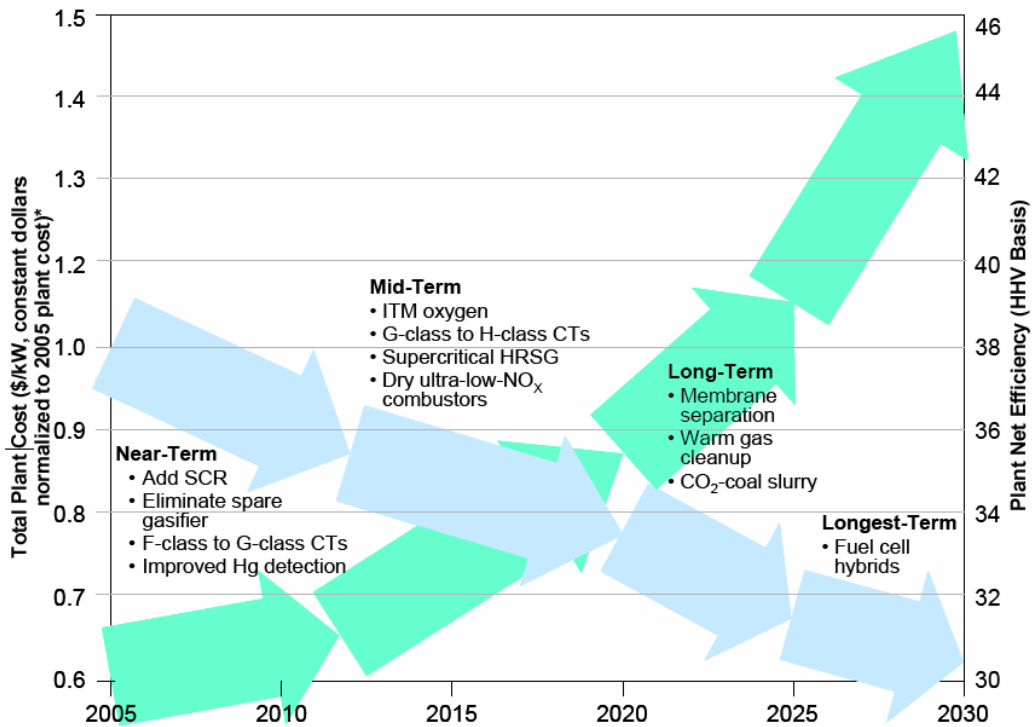

*For a slurry-fed gasifier designed for 90% unit availability and 90% pre-combustion CO₂ capture using Pittsburgh #8 bituminous coal; cost normalization using Chemical Engineering Plant Cost Index or equivalent. A similar trend is observed in analyses of dry-fed gasifiers using Power River Basin sub-bituminous coal, although the absolute values vary somewhat from those shown)

Figure 2.25. RD&D Path for Capital Cost Reduction (falling arrows) and Efficiency Improvement (rising arrows) for IGCC Power Plants with 90% CO₂ Capture

Need to Address Multiple Approaches

The portfolio aspect of advanced coal with integrated CCS technologies must be emphasized because no single advanced coal technology (or any generating technology) has clear-cut

economic advantages across the range of applications. The best strategy for meeting future electricity needs while addressing climate change concerns and minimizing economic disruption lies in developing a *full portfolio* of technologies from which power producers—and their regulators—can choose the option best suited to local conditions and preferences and still provide power at the lowest cost to the customer. Toward this end, four major technology efforts related to CO₂ emissions reduction from coal-based power systems must be undertaken:

1. Increased efficiency and reliability of integrated gasification combined cycle (IGCC) power plants
2. Increased thermodynamic efficiency of pulverized-coal (PC) power plants
3. Improved technologies for capture of CO₂ from coal combustion- and gasification based power plants
4. Reliable, acceptable technologies for long-term storage of captured CO₂

Identification of mechanisms to share RD&D financial and technical risks and to address legal and regulatory uncertainties must take place as well.

In short, a comprehensive recognition of all the factors needed to hasten deployment of competitive, commercial advanced coal and integrated CO₂ capture and storage technologies — and implementation of realistic, pragmatic plans to overcome barriers — is the key to meeting the challenge to supply affordable, environmentally responsible energy in a carbon-constrained world.

Figure 2.27 depicts the major activities in each of the four technology areas that must take place to achieve a robust set of integral advanced coal/CCS solutions. Important, but not shown in the figure, are the interactions between RD&D activities. For example, the ion transport membrane (ITM) oxygen supply technology shown under IGCC can also be applied to oxycombustion PC units. Further, while the individual goals related to efficiency, CO₂ capture, and CO₂ storage present major challenges, significant challenges also arise from complex interactions that occur when CO₂ capture processes are integrated with gasification- and combustion-based power plant processes.

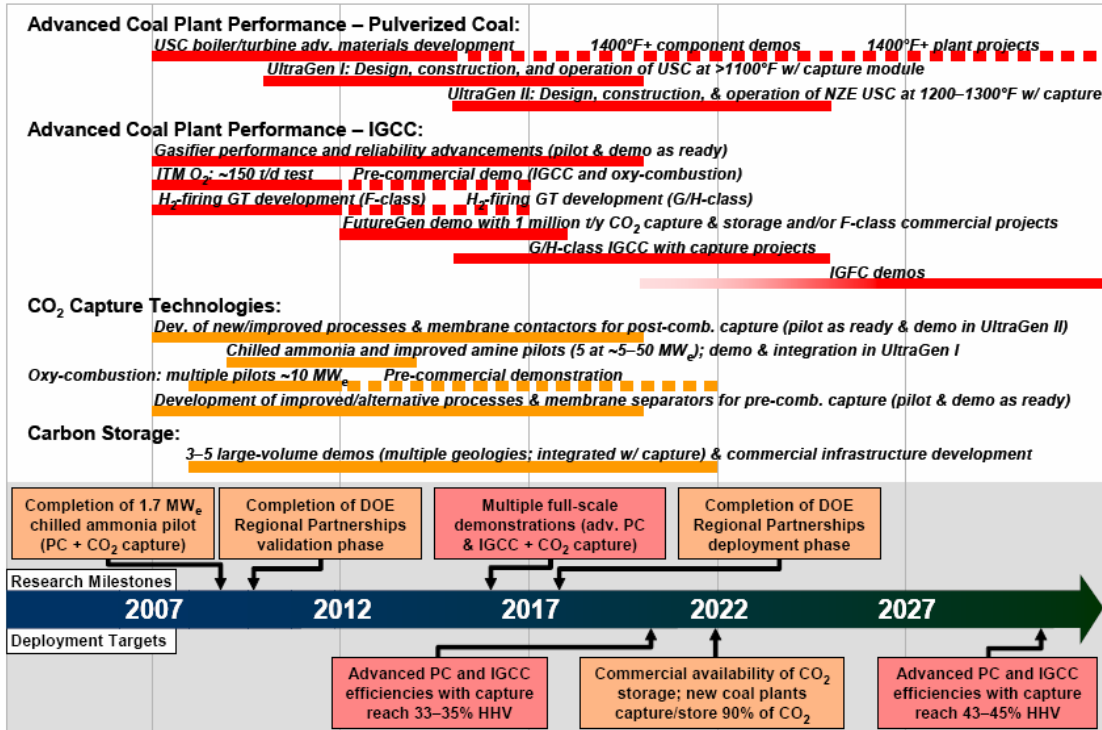

Source: *The Power to Reduce CO₂ Emissions – the Full Portfolio*, <http://epri-reports.org/DiscussionPaper2007.pdf>

Figure 2.26. Timing of Advanced Coal Power System and CO₂ Capture and Storage RD&D Activities and Milestones

REFERENCES

- Aaron, D. and C. Tsouris. "Separation of CO₂ from Flue Gas: A Review," *Separation Science and Technology*, 40 (2005), 321-348.
- "Alstom and American Electric Power Sign Agreement to Bring CO₂ Capture Technology to Commercial Scale by 2011," Press Release; March 15, 2007.
- Archer, M. "Climate Strategy"; FPL Group Progress Report, EUEC, Tucson, AZ; January 23, 2007.
- Beér, J.M. "High Efficiency Electric Power Generation: The Environmental Role," *Progress in Energy and Combustion Science*, 33 (2007), 107-134.
- Bullinger C., M. Ness, and N. Sarunac. "One Year of Operating Experience with Prototype Fluidized Bed Coal Dryer at Coal Creek Generating Station," 32nd International Technical Conference on Coal Utilization and Fuel Systems, Clearwater FL; June 10–15, 2007.
- Climate Change Technology Program
<http://www.climatetechnology.gov/library/index.htm> (Accessed April 1, 2008).
- Davis, M.B., William R. Toombs, John M. Boyle et al. "Controlling SO₃, slag and fouling resulting in improved heat rates, efficiency and allowing for fuel flexibility— Cross Station Case Study," Electric Utility Environmental Conference January 28, 2008.
- Energy Information Administration (EIA), USDOE, *Impacts of the Kyoto Protocol on U.S. Energy Markets and Economic Activity*, SR/OIAF/98-03 (Washington, DC, October 1998), web site www.eia.doe.gov/oiaf/kyoto/kyotorpt.html.
- Energy Information Administration (EIA), USDOE. *Annual Energy Outlook 2002*, DOE/EIA 0383(2002) (Washington, DC, December 2001).
- Energy Information Administration (EIA), USDOE. 2005 annual statistics www.eia.doe.gov.
- Fisher. K.S., C. Beitler, R. Curtis, and K. Searcy. "Integrating MEA Regeneration with CO₂ Compression and Peaking to Reduce CO₂ Capture Costs," Final Report of DE-FG02-04ER84111; June 9, 2005.
- Hannegan, Bryan. EPRI Testimony for the Hearing of the Science, Technology and Innovation Subcommittee of the Committee on Commerce, Science, and Transportation, Testimony to the US Senate; November 7, 2007.
- Haq. "Biomass for Electricity Generation," Energy Information Administration (EIA). IEA Greenhouse Gas R&D Programme (IEA GHG). "Estimating Future Trends in the Cost of CO₂ Capture Technologies," 2006/5 (January 2006).
- Larsen, C. "Electric Power Research Institute," *Energy Biz.*; Nov./Dec. 2007, 52.
- Lehmann, J.; Gaunt, J.; Rondon, M. "Bio-Char Sequestration in Terrestrial Ecosystems – A Review," *Mitigation and Strategies for Global Change*, 11, 2006, 403-427.
- MIT. "Study on The Future of Coal," (2007).
- National Coal Council. "Increasing Electricity Available from Coal- based Generation in the Near-Term," May 2001.
- National Energy Technology Laboratory. "Tracking New Coal- based Power Plants," February 18, 2008.
www.netl.doe.gov/coal/refshelf/ncp.pdf (Accessed May 2008).
- Olah, G.A., A. Goeppert, and G.K.S. Prakash. *Beyond Oil and Gas: The Methanol Economy* (Wiley-VCH: Weinheim, Germany, 2006), 209-259.

- Rhudy, D.; Black, S. *Chilled Ammonia Process Update*, CO₂ Capture Network, Lyon, France; May, 2007.
- Rising, B. Siemens. "Mitigation of CO₂ Emissions from Power Plants", EUEC, Tucson, AZ, January 20-22, 2007, 19.
- Sangras R., F. Chatel-Pelage, P. Pranda, H. Farzan, S. Vecci, and Y. Lu. "Oxy-combustion process in pulverized coal boilers; a promising technology for CO₂ capture". Proceedings of the 29th international technical conference on coal utilization and fuel systems, Clearwater, FL; April 2004.
- United States Department of Energy (DOE)
<http://www.netl.doe.gov/technologies/coalpower/fuelcells/hybrids.html>
- United States Department of Energy (DOE) and Office of Fossil Energy Advanced Turbine Program. FY 2007 "Annual Report," September 2007.
- Yagi, Y., T. Mimura, T. Yonekawa, and R. Yoshiyama. "Development and Improvement of CO₂-Capture System,"
http://www.mhi.co.jp/mcec/product/recov_co2/download/pdf/GHTH8_Development.pdf
(Accessed February 2008).

Chapter Three

Legal and Regulatory Dimensions of Carbon Capture and Storage

If the country is to control CO₂ emissions, it needs to accelerate CCS research. There is uncertainty as to whether our understanding could be sufficiently furthered by the time some policy makers aim to begin CCS and whether we can gain enough knowledge to ensure that CO₂ storage on the scale envisioned is actually viable. Any legal regime that imposes restrictions on carbon emissions must recognize the status and development of technical understanding regarding CCS. Moreover, the legal regime applicable to CCS activities should be as simple, and as unified as possible. Because the storage of carbon emissions to address climate change is an activity aimed to address a social purpose rather than serve an economic goal, the applicable legal and liability regimes should be designed to encourage rather than discourage CCS development.

FINDINGS

The NCC finds the following:

1. If atmospheric CO₂ emissions are to be controlled, carbon capture and storage (CCS) is the only means available to address very large quantities of CO₂ emissions from coal-fired facilities. However, it is a tool that requires significant additional research and the definition of a stable legal regime.
2. If carbon constraints are applied at the state or federal level, CCS may need to develop very quickly in order to maintain reliable and secure energy supplies. The legal regime applicable to CCS is very important, both to encourage its development and to speed the appropriately considered approval of needed projects.

RECOMMENDATIONS

The NCC recommends that the Secretary work with various parties, most particularly the states and other federal agencies, to promote a legal framework for CCS that will encourage rather than discourage its development. A legal framework to encourage development of CCS would include the following elements:

1. A single clear regulatory scheme administered by as few government agencies as possible, rather than multiple regulatory regimes with inconsistent or conflicting requirements.
2. Clear definition and assignment of risks under a single liability regime, rather than unclear, vague liabilities potentially posed under a variety of State and federal statutes.

INTRODUCTION

If atmospheric CO₂ emissions are to be controlled, carbon capture and storage (CCS) is the only means available to address very large quantities of CO₂ emissions from coal-fired facilities. However, it is a tool that requires significant additional research and the definition of a stable legal regime.

If the country is to control CO₂ emissions, it needs to accelerate CCS research. There is uncertainty as to whether our understanding could be sufficiently furthered by the time some policy makers aim to begin CCS and whether we can gain enough knowledge to ensure that CO₂ storage on the scale envisioned is actually viable. Any legal regime that imposes restrictions on carbon emissions must recognize the status and development of technical understanding regarding CCS. Moreover, the legal regime applicable to CCS activities should be as simple, and as unified as possible. Because the storage of carbon emissions to address climate change is an activity aimed to address a social purpose rather than serve an economic goal, the applicable legal and liability regimes should be designed to encourage rather than discourage CCS development.

CCS involves the capture, transport, underground injection, and long-term storage of CO₂. The technology and engineering capability exists today to capture and geologically sequester CO₂, and it has been deployed in a few instances on a relatively large scale. For example, the Sleipner natural gas processing project in Norway, the In Salah natural gas project in Algeria, and the Weyburn enhanced oil recovery (EOR) project in Canada currently store 1-2 million metric tons of CO₂ per year in underground formations. Other projects are being planned worldwide. However, CCS has not yet been demonstrated in conjunction with large coal-fired power plants, nor on the scope and scale required to meaningfully address CO₂ emissions.

The United States has nearly 1,500 coal-fired electric generating units, which collectively produce about half of the electricity used nationwide each year. Coal-fired electricity production accounts for 36% of America's CO₂ emissions each year. Coal also is a vital source of energy for other industrial processes, such as the manufacture of steel and cement.

Whether to apply CCS technology to new coal-fired generation is an issue coming to a head in situations across the United States. Some states already have passed laws designed to reduce greenhouse gas emissions, and Congress has signaled that it may soon do the same. The U.S. Supreme Court recently ruled in *Massachusetts v. EPA* that the federal government has the authority to regulate CO₂ and other greenhouse gases as pollutants under the Clean Air Act. Financial institutions now are factoring in the risks from CO₂ emissions in their underwriting processes. New coal-fired power plants are facing increasing difficulties in gaining approval from state authorities. Various parties already are acting to address GHG emissions.

From a legal standpoint, emission reductions to existing coal-fired facilities have become more difficult to make given changes in the legal interpretation of New Source Review (NSR) requirements under the Clean Air Act. Plant maintenance that results in efficiency improvements such as replacement of turbine blades with more efficient ones or the installation of new feedwater condensers, fans, and other equipment may result in fewer CO₂ emissions but

also trigger additional action under the NSR, such as the installation of expensive equipment to reduce other air emissions. This deters investment in efficiency. Installation of CCS equipment at existing power plants may invoke NSR requirements as well.

As the country continues to consider responses to greenhouse gas emissions, the issue becomes no easier. The U.S. population is expected to grow by 60 million people by 2030. During that time, electricity demand will increase by 33 to 50 percent. An even more populous country, and a far more populous world, will need electricity, transportation, food production, and manufacturing industries that require more energy. Meeting this demand raises concerns over America's energy security, as the prices of oil and natural gas continue to rise. Alternatives such as nuclear and renewable energy, in conjunction with demand management measures, would not be enough to prevent the need for new coal-fired facilities—even if deployed at unprecedented levels.

CCS can offset the potential climate impacts from the CO₂ emissions associated with coal-fired power plants and ensure a vital role for America's 250-year supply of coal in meeting future energy demand and providing energy security. The industrial-scale deployment of CCS hinges on identifying and resolving key regulatory and liability issues, given the risks involved with capturing, transporting, injecting, and storing large amounts of CO₂.

This chapter will outline the phases of carbon capture and storage and the possible pathways to risk, discuss the ramifications if a problem was to occur in the CCS chain, and highlight the legal regimes that apply or are potentially applicable to CCS.

PHASES OF CCS AND ITS POTENTIAL RISKS

The capture, transport, underground injection, and long-term storage of CO₂ may pose potential risks in one of three ways:

- through leaks
- through pressure
- via trespass or other torts

The risks may be to human health, the environment, or property. These scenarios include risks of human exposure, groundwater contamination, subsurface resource damage, trespass, and induced seismicity events and surface alteration. It also poses economic risks. For example, depending on how a regime is implemented to restrict CO₂ emissions, businesses may need to cease operation if emissions are not controlled or are accidentally released. This results in both the interruption of business and, potentially, the loss of carbon credits.

Exposure to high concentrations of CO₂, typically 7-10 percent or greater by volume in air, can be harmful to humans, as well as animal and plant life. CO₂ is denser than air and upon release from a pipeline or an underground storage site can accumulate in potentially dangerous concentrations in low-lying areas. Population density, local topography, and local meteorological conditions are key factors in determining the likelihood of exposure to high concentrations of CO₂, should high concentrations be released to the atmosphere. If released, CO₂ will vaporize over a relatively short period of time.

The injection and long-term storage of CO₂ can contaminate underground sources of drinking water. Injected CO₂ can migrate from an underground storage site through undetected faults and fractures or through improperly drilled injection wells. It may enter directly into aquifers or displace brines or other substances into aquifers. Injected CO₂ also can displace toxic metals, sulfates, or chloride into aquifers. The likelihood of contamination of underground sources of drinking water by displaced brine or chemicals can be reduced if there is proper site characterization, selection, and monitoring. In addition to affecting water supply, the accumulation of leaked CO₂ just beneath the surface can cause soil acidification and displace oxygen in soils.

The migration of CO₂ also can damage other underground resources, such as hydrocarbon resources during an EOR operation. As would be the case with drinking water contamination, the CO₂ may displace brine, which could foul oil or gas reserves. There is precedent in oil extraction and underground storage of natural gas for recovery of damages under tort law, as well as established protocols for evaluating damage to cropland or forests.

The injection of CO₂ also poses slight risk of triggering seismic events or causing land deformation or subsidence. An induced seismic event can compromise the integrity of the storage site by damaging the injection well and creating or exacerbating faults. Induced seismic events and other geologic hazards, such as ground heave, usually are triggered by excessive injection pressures and have been documented at hazardous waste disposal wells, oil fields, and other sites. In 1966, two earthquakes with Richter magnitudes of 5.1 and 5.2 were triggered by injection near Denver, Colorado. Injection of supercritical CO₂ poses special considerations because it can interact with surrounding rock and water in a storage site and reduce permeability. This can ensure its permanent storage, but also can result in pressure build up that potentially could lead to seismic activity. Induced seismic activity may be prevented through proper siting, installation, operation, and monitoring.

With proper site characterization, design and operational standards, and management of CCS activities, most risks are expected to be manageable. However, until a track record is developed of sequestering CO₂ on the scale and in the formations envisioned in legislation to reduce carbon emissions, there is likely to be hesitance among potential investors and risk managers, such as insurers, to participating in CCS projects.

Capture of CO₂

The capture of CO₂ typically occurs on-site at a power plant or other large source of emissions. Once the CO₂ is captured, it will be compressed to a supercritical state for efficient transport. For the volumes emitted by a major coal-fired power plant, transportation is envisioned to be predominantly by pipeline.

The capture phase presents two primary risks. First, while capture technologies are expected to be effective, their use on large-scale, coal-fired power plants will, in some cases, be a new application and technical bugs are likely. Depending on the regulatory scheme or schemes in place, it is unclear whether plant operations might have to be interrupted while capture

equipment is being repaired. This issue applies not only to the capture phase, but to all CCS phases. Second, there will be high costs and energy use from capture and compression technologies.

The capture of CO₂ is possible either pre-combustion or post-combustion. The primary pre-combustion technology envisioned is integrated gasification combined cycle (IGCC), through which coal is partially combusted to produce a SNG, from which CO₂ is relatively easily separated and captured. Post-combustion carbon capture may happen through one of several technologies.

Post-combustion capture of CO₂ presents a variety of technical challenges. The low pressure and dilute concentration requires a high volume of gas that needs to be treated to separate the CO₂. Trace impurities in the flue gas can slow the capture process and create risks in pipeline transport and storage. In addition, compressing the captured CO₂ for transport and underground injection uses significant amounts of energy and increases costs. The National Energy Technology Laboratory (NETL) indicates that use of aqueous amine capture technology, one of several that could come into use, would “raise the cost of electricity from a newly-built supercritical pulverized coal power plant by 84 percent, from 4.9 cents/kWh to 9.0 cents/kWh.”

The pre-combustion capture of CO₂ is possible with integrated gasification combined cycle (IGCC) technology. IGCC results in lower emissions of sulfur dioxide, particulates, and mercury by turning coal into a gas and removing impurities from the gas prior to combustion. NETL estimates that carbon capture would increase the cost of electricity at IGCC plants by 25 percent, from 5.5 cents/kWh to 6.5 cents/kWh. Even without carbon capture, electricity at IGCC plants is expected to be more expensive than at conventional plants because of the increased costs to build an IGCC plant, versus a new pulverized coal plant.

IGCC technology offers co-benefits, such as the production of hydrogen, which can be burned as a clean source of energy. Carbon capture is more efficient when done pre-combustion, because a relatively concentrated CO₂ stream can be captured before it is mixed with air through the combustion process.

In addition to technology hurdles, the potential of climate change regulation limiting CO₂ emissions raises some concern over business interruption risk in cases where capture and compression equipment goes offline. To avoid facing penalties for exceeding emissions limits, emitting facilities may have to choose between suspending operations or purchasing additional emissions allowances or offset credits to cover excess emissions.

Transportation of CO₂

A main risk with CO₂ transportation, which is expected primarily to occur via pipeline, is corrosion that could necessitate expensive repairs and may bring about some CO₂ leakage into the atmosphere. Pipeline length will vary depending on the proximity of the generating facility to the geologic storage site. The transportation of CO₂ by pipeline is not likely to present any high-probability/high-damage risks and could be managed using existing regulatory frameworks.

It is possible to transport CO₂ by truck, rail, and ship, as well as by pipeline. But CCS deployment may require an interstate pipeline transmission system dedicated to CO₂ transport to handle the potentially enormous quantities of CO₂ involved, especially if CCS is applied to existing coal-fired facilities, which may or may not be located near long-term storage sites. More than 3,600 miles of CO₂ pipeline already exist in the United States, primarily in Texas, New Mexico, and Wyoming. The existing pipeline infrastructure can transport approximately 40 million metric tons of CO₂ per year, which today is used for EOR and other industrial purposes.

Commercial-scale CCS deployment could require a much larger infrastructure, with one estimate predicting 100,000 miles of new pipeline. By comparison, there are nearly 500,000 miles of natural gas and hazardous liquid transmission pipeline in the United States. But considerable uncertainty persists over the size and configuration of an expanded CO₂ pipeline system. Indeed, there are questions over the extent to which long pipeline transportation will be required at all, particularly in the early going, when most CCS projects are likely to be proposed in conjunction with power plants or other large emitting industrial facilities with on-site injection and sequestration capability. Research suggests that 77 percent of CO₂ captured from North American sources could be stored in reservoirs directly beneath these sources, and an additional 18% may be stored within 100 miles of storage reservoirs. But uncertainties over the long-term storage capabilities of some underground reservoirs may require transporting CO₂ to proven locations.

Carbon dioxide reaches a liquid state in combinations of high pressure and low temperature and generally is transported in liquid or gas form. The purity of the CO₂ being transported is important, as the presence of hydrogen sulfide can increase the likelihood of pipeline corrosion. Furthermore, CO₂ and water mix to form carbonic acid, which can be highly corrosive. There were no injuries or fatalities resulting from the 12 reported incidents from CO₂ pipelines reported from 1986 to 2006. By comparison, there were 5,610 incidents causing 107 fatalities and 520 injuries related to natural gas and hazardous liquids (excluding CO₂) pipelines. As the CO₂ pipeline network expands, the rate of incidents is predicted to be similar to those for natural gas pipeline transmission.

The U.S. Department of Transportation (DOT) has primary authority to regulate interstate CO₂ pipeline safety under the Hazardous Liquid Pipeline Act of 1979. Under the Act, the DOT regulates the design, construction, operation and maintenance, and spill response planning for CO₂ pipelines. The DOT administers pipeline regulations through the Office of Pipeline Safety within the Pipeline and Hazardous Materials Safety Administration (PHMSA). Under DOT regulations, CO₂ is listed as a Class 2.2 (non-flammable gas) hazardous material, but the agency applies nearly the same safety requirements to CO₂ pipelines as those carrying hazardous liquids such as crude oil, gasoline, and anhydrous ammonia.

Other regulatory models, such as those currently used for oil and natural gas pipelines, could be adapted for an expanded CO₂ pipeline system.

Injection and Long-Term Storage

Risks associated with CCS are most likely to occur during long-term storage. The potential risks include leakage, over-pressurization, and migration of the CO₂ plume.

Storage of CO₂ is expected to occur primarily at depths between 800 and 1,000 meters. At these depths, CO₂ is at a supercritical state with a liquid-like density that enables its secure storage in the pores of sedimentary rocks. When stored underground at these depths, its density will range from 50-80 percent of the density of water. As a result, its buoyancy and viscosity will tend to drive it upward unless it is properly contained.

Proper containment depends on a highly porous and permeable underground formation with a thick seal or caprock to prevent leakage into overlying formations. NETL describes the following as suitable for geologic sequestration:

- Caprock trapping: an impermeable layer of low-porosity rock serves as a barrier against upward migration of CO₂
- Pore space trapping: through capillary and surface tension forces, droplets of CO₂ become affixed into a rock pore space (primarily for oil and gas formations, and also for saline formations to some extent)
- Solubility trapping: dissolution of CO₂ in saline water, as CO₂ is soluble in brine. For example, at 1900 psi and 30,000 ppm TDS, one gallon of brine holds 0.4 pounds of CO₂ (primarily for saline formations and basalt formations, and also for oil and gas formations to some extent)
- Mineralization: once in solution, CO₂ will react, albeit at a slow rate, with dissolved minerals to form solid mineral carbonates (primarily for high magnesium content basalts, and for saline formations)
- Adsorption: unmineable coal seams offer a unique storage mechanism as CO₂ molecules adsorb onto the surface of the coal. Adsorbed CO₂ exists as a condensed liquid and is immobile so long as the formation pressure is maintained.

The length of time for this to occur depends on a variety of physical conditions, including the chemical composition of the formation. The containment of CO₂ in a geological reservoir is predicted to be *very likely* to exceed 99 percent over 100 years, and *likely* to exceed 99 percent over 1,000 years. As a result, CCS projects are predicted to be unlikely to threaten human life or cause many of the other surface or subsurface disturbances likely to occasion liability.

Where a storage site's containment is breached, leakage can occur abruptly, through injection well failure or up an abandoned well, or it can occur gradually, through undetected faults, fractures, or wells. The U.S. Government Accountability Office has reported that most leakage from injection wells occurs through improper well design and maintenance, such as from faults in well casing, excessive injection pressure, the presence of improperly abandoned wells, corrosion of the well casing or tubing, and other aspects. Wells typically are sealed with cement

plugs that can degrade over time from the build up of carbonic acid, which forms when CO₂ is injected in subsurface formations containing brine.

A monitoring, mitigation, and verification (MMV) regime can ensure the secure, long-term storage of CO₂. MMV regimes are designed to measure and track the amount of stored CO₂, monitor the storage site for leaks or other deterioration of the storage site, and verify that the amount of CO₂ that is being securely stored and not posing a threat to the surrounding area. According to the NETL, such MMV regimes include: “assessing the integrity of plugged or abandoned wells in the region; calibrating and confining performance assessment models; establishing baseline parameters for the storage site to ensure that CO₂-induced changes are recognized; detecting microseismicity associated with the storage project; measuring surface fluxes of CO₂; and designing and monitoring remediation activities.”

LEGAL AND REGULATORY CONSIDERATIONS

As of yet, there is no single coordinated framework covering the siting, underground injection, closure, and long-term storage associated with CCS. Should a new federal regulatory framework emerge, it is not clear how comprehensive it may be, or how it may interact with state regulatory regimes. Thus, it has yet to be determined as to what statutory and regulatory provisions CCS project owners and operators may be held accountable. In addition, common law theories such as trespass may apply in the CCS context.

The U.S. Environmental Protection Agency (EPA) currently regulates CCS injections under the Underground Injection Control (UIC) program, the authority for which is provided under the Safe Drinking Water Act (SDWA). Other federal programs may apply as well, as described below.

States are most likely to regulate CCS activities under statutes that parallel federal statutes and were enacted in order to satisfy requirements in federal laws that to have status as the lead regulator, States would need to adopt laws no less stringent than federal law. However, states also recently have adopted other laws affecting CCS.

Federal Regulation

UIC Program

The SDWA establishes federal regulation to protect drinking water sources. The Underground Injection Control (UIC) program within the SDWA regulates the discharge of fluids beneath the surface to ensure that any underground injection activities will not endanger underground sources of drinking water.

Under the UIC program, states that develop their own UIC programs that meet the requirements of the federal program can assume primary responsibility in implementation and enforcement. Thus far, 33 states have been granted primacy, seven states operate under a joint federal/State program, and underground injections in ten states are regulated directly by the EPA.

There are five classes of injection wells established by the EPA in the UIC program. These include:

- Class I: Hazardous wastes, industrial non-hazardous liquids, or municipal wastewater beneath the lowermost underground sources of drinking water
- Class II: Brines and other fluids associated with oil and gas production, and hydrocarbons for storage beneath the lowermost underground sources of drinking water
- Class III: Fluids associated with solution mining of minerals beneath the lowermost underground sources of drinking water
- Class IV: Hazardous or radioactive wastes into or above underground sources of drinking water. These wells are banned unless authorized under a federal or state groundwater remediation project
- Class V: All injection wells not included in Classes I-IV. In general, Class V wells inject non-hazardous fluids into or above underground sources of drinking water and are typically shallow, on-site disposal systems. However, there are some deep Class V wells that inject below underground sources of drinking water

Regulations promulgated under SDWA establish minimum requirements for all injection wells. These requirements generally pertain to site and injection formation characterization, well construction, operation, testing, and periodic monitoring and reporting. Requirements are most stringent for Class I wells injecting hazardous waste. Even if administered at the state level, operators of Class I hazardous waste wells must receive approval from the regional EPA office of a “no-migration demonstration” as required by the Resource Conservation and Recovery Act (RCRA). A no-migration demonstration is designed to ensure zero contamination and requires operators to demonstrate that wastes will not migrate from the injection zone for at least 10,000 years or will be rendered harmless via chemical transformation.

In March 2007, the EPA issued Final Guidance for processing permit applications for pilot projects to test CO₂ injection technologies as Class V wells, which authorizes state, tribal, and EPA Regional offices to issue Class V permits beginning in March 2009.

The EPA is planning to issue a proposed rule on the injection of CO₂ for CCS under the UIC program in July 2008 with a final rule expected by late 2009 or 2010. Among the key issues in the rulemaking are the size of area the EPA requires applicants to review in advance of injection and storage, as discussed above; post-closure care requirements, including the period of financial responsibility; and the potential application of RCRA and the Comprehensive Environmental Response, Compensation, and Liability Act (CERCLA or Superfund).

In the rulemaking, the EPA is considering creating a new “Class VI” category well that would take into account the special considerations involved with CCS, including the volume of CO₂ that potentially could be injected, its corrosivity, as well as the unusual buoyancy and viscosity of supercritical CO₂. The EPA is considering other issues such as the need to require secondary

containment (i.e. a second formation of “caprock” above the initial formation), which could limit the eligibility of potential storage sites, raise costs due to extra transportation, and add to the administrative burden of regulating site characterization.

The EPA also is assessing what to require with regard to post-closure maintenance, monitoring and verification, especially in cases where the underground CO₂ plume has migrated. This may or may not involve the use of tracers or special isotopes that can be mixed in with the CO₂ to identify it if it mixes in with other underground material. Moreover, the EPA is considering whether to require that wells use corrosion-resistant materials.

The Interstate Oil and Gas Compact Commission (IOGCC), which comprises 31 states, proposed giving states primacy under the UIC program and continuing to regulate the injection of CO₂ for EOR as Class II wells. For CO₂ injection without EOR, IOGCC proposed treating CO₂ like natural gas, which is considered a commodity and has received a statutory exemption from the SDWA. The regulation and permitting of natural gas storage is generally conducted at the state level, and natural gas injection wells are often regulated as Class II wells under appropriate state UIC programs. Post-closure monitoring is generally not required, because upon closure as much natural gas as possible will have been drawn from the reservoir. Alternatively, the IOGCC proposed a new sub-classification for Class II wells or a new classification of wells to be established. Above all, IOGCC opposed regulated CO₂ injection for CCS as a Class I or Class V well.

CERCLA

Policy makers should take care to avoid the applicability of the federal Superfund program to injections of CO₂. Superfund is a liability scheme, rather than a regulatory scheme, that provides for joint, strict, and severe liability for the “release” of a “hazardous substance.” A hazardous substance is defined by the so-called “list of lists”—if a substance is regulated or controlled under one of a number of other federal statutes, it is a hazardous substance under Superfund.

The *Massachusetts v. EPA* case, in which the Supreme Court found that CO₂ was a pollutant and left the EPA to determine how it should be regulated, could affect the relationship of the Superfund program to CCS activities. If the EPA decides to control CO₂ as a hazardous air pollutant under Section 112 of the Clean Air Act, CO₂ then will meet the definition of a hazardous substance under CERCLA. The implication is that should a leak occur, the storage site owner, operator, and all others involved with the site, including those who sent CO₂ for storage, potentially could be liable.

Superfund also provides that the federal government may respond in cases of “an imminent and substantial danger to the public health or welfare” caused by release of a “pollutant or contaminant.” A pollutant or contaminant is defined very broadly and likely would include releases of CO₂ today, if they are deemed to pose an imminent and substantial danger. The federal government may sue responsible parties to recoup costs incurred by the government for the response.

CERCLA Section 107(j) provides a safe harbor from liability for “federally permitted releases,” including those under the Underground Injection Control program. However, the exception likely would not apply in cases where CO₂ accidentally has leaked from the storage site and caused damage.

RCRA

The Resource Conservation and Recovery Act (RCRA) controls the disposal of “hazardous wastes.” RCRA’s requirements for treatment, transportation, storage, and disposal of a hazardous waste are very extensive and expensive.

Some are seeking to ensure that CO₂ is not viewed as a “waste,” and that CCS activities are not viewed as waste disposal activities that would trigger RCRA or state statutes applying to waste disposal. RCRA defines a “solid waste” as, among other things, “discarded material, including solid, liquid, semisolid, or contained gaseous material resulting from industrial . . . operations.” A “hazardous waste” is “a solid waste . . . which, because of its quantity, concentration, or physical, chemical, or infectious characteristics may . . . pose a substantial present or potential hazard to human health or the environment when improperly treated, stored, transported, or disposed of, or otherwise managed.” Hazardous wastes are either “listed” wastes (i.e., wastes that EPA has specifically identified as hazardous) or “characteristic” wastes (i.e., wastes considered to be hazardous because they meet the above definition and are ignitable, corrosive, reactive, or toxic). Notwithstanding the inappropriateness of applying RCRA’s very complicated and costly regulatory regime to CCS, it is possible that RCRA’s provisions could be interpreted to apply to underground storage of CO₂.

RCRA Subtitle C minutely regulates the generation, transportation, storage, and disposal of hazardous wastes in a manner too cumbersome for processes involving the volumes expected to be handled through CCS processes. This is especially true given that CO₂ has low toxicity except if, upon release, it remains in very high concentrations. RCRA §3001 exempts other high-volume, low-toxicity wastes, including oil and gas production wastes, coal combustion byproducts, mining wastes, and cement kiln dust. An exemption for CCS seems appropriate, especially given that it will be regulated under another federal environmental program.

Pursuant to federal regulations, a UIC permit holder need not get a RCRA permit, but the applicability of RCRA and the interplay of the two programs are more complicated issues. To reduce permitting duplication and provide for both a hazardous waste permit and UIC permit (in the case of injecting hazardous wastes), regulations for RCRA’s hazardous waste program grant UIC owners and operators a permit-by-rule, thus requiring the owner/operator to apply for only a UIC permit. However, the UIC permittee still must meet certain RCRA requirements. So while a UIC permittee need not get a RCRA permit, the permittee still must assure compliance with RCRA provisions. Therefore, having a UIC permit does not completely insulate a UIC permit holder from RCRA liability.

An additional RCRA issue is the citizen suit authority in Section 7002. This authority raises the specter that anti-coal activists could file suit for “contributing to the past or present handling, storage, treatment, transportation, or disposal of any solid or hazardous waste which may present

an imminent and substantial endangerment to the health or the environment.” It is unclear whether EPA could, via a UIC program regulation, prevent the filing of a citizen suit under RCRA.

Clean Air Act

For existing coal-fired facilities, a major question is whether the Clean Air Act, including the New Source Review (NSR) requirements of the Act, would apply if CCS equipment is installed.

NSR requirements are triggered by a physical change or change in method of operation that result in a significant net emissions increase. Installing carbon capture equipment would constitute a "physical change" under NSR. The next inquiry is whether the change would result in a significant net emissions increase. It could be argued that it might. For example, using amine scrubbers to capture CO₂ might result in an increase in particulate matter emissions from the plant, such as small, entrained droplets of absorbant. Carbon capture might require the heat input of the plant to increase—for example, to meet the load from running capture equipment or CO₂ compressors. This might cause emissions to increase from coal handling or, perhaps, stack emissions of collateral pollutants such as NO_x.

For a long time, NSR requirements were interpreted so that the installation of pollution control equipment did not trigger compliance with NSR requirements. That interpretation no longer applies. As a result, installing SCRs on coal-fired power plants now regularly triggers the need for an NSR permit. SCRs reduce NO_x emissions from a typical coal-fired power plant by hundreds of tons per year. However, SCRs generally result in a small increase in emissions of sulfuric acid mist. This characteristic of SCRs was not well understood until large SCRs were installed and emission profiles. This may be a cautionary tale for policy makers to consider with regard to CCS.

State and Local Legalities

Geophysical surface and subsurface trespass are among the primary risks associated with the siting of CCS projects. Surface trespass involves conducting site testing and monitoring and verification activities. Subsurface trespass involves underground migration of injected CO₂ into areas where property interests have not been acquired, as well as from waves shot for 3-D seismic mapping. Commingling of goods represents another subsurface trespass concern relevant to CCS operations. Both surface and subsurface trespass risks underscore the importance of accumulating the necessary property rights prior to proceeding with a CCS project, possibly using unitization or eminent domain powers.

Unitization is the joining of individual tracts into one common pool and is frequently used in conjunction with secondary oil recovery operations. Most oil-producing states require 50 to 85% of owners of a common oil pool to agree before unitization can occur. The exercise of eminent domain is a state- or federal-level function, where the government can expropriate private property for projects designed to benefit the public.

There are two types of property interest relevant to determining ownership of the geologic storage formation and resolving liability issues, the mineral interest and the surface interest. The mineral interest concerns the right to explore and remove minerals from the land. This can include or be associated with a royalty interest, which involves the right to receive a share of the proceeds from the exploitation of the mineral resources. In most states, the mineral interest includes both stationary minerals such as coal, as well as oil and gas resources. The surface interest includes all other ownership in the land. In most states, the owner of the surface interest also owns the geologic formation beneath it, including the saline formation. The injection and storage of CO₂ in saline formations, as opposed to, for example, unmineable coal beds or depleted hydrocarbon reservoirs, raises questions over the ownership of the water contained in the saline formation, as some states rely on different legal and regulatory regimes to determine ownership over water resources. Water in saline formations is typically unusable, and most case law on point focuses on property rights over the taking and use of groundwater for consumption.

In addition, there are two kinds of private liability especially relevant to CCS: tortious liability and liability for breach of contract. A threshold issue for tortious liability for CCS storage, where the harm may occur far into the future, is whether the cause of action would be barred by a statute of limitations or, possibly, a statute of repose. The key difference between a statute of limitations and a statute of repose is that a statute of limitations begins to run upon the manifestation of the plaintiff's injury, whereas the statute of repose begins to run upon the conclusion of the defendant's activities which, eventually, gave rise to the injury. Statutes of repose typically tend to refer to a specific type of activity, such as the liability of an architect for a building intended to have an indefinite lifespan. Such statutes are, in effect, determinations by a legislature that not all injuries should be compensated and are often justified on grounds of fairness to the defendant.

Breach of contract raises special considerations with CCS projects, given the likelihood that CO₂ emissions will be subject to regulation in near future, possibly as part of a cap-and-trade program that has the effect of monetizing emissions reductions or, in the case of CCS, monetizing avoided emissions. It is not yet clear what role, if any, CCS would have in a cap-and-trade scheme, but allowing the injection of CO₂ to generate emissions allowances or credits raises serious breach of contract issues in the event of a project failure. In particular, a catastrophic release of thousands or millions of tons of CO₂ from a geologic reservoir could force operators into non-compliance with emissions caps and open the door to lawsuits from counterparties if the carbon credits they obtained from CCS projects were invalidated.

Regulation of Pipeline Sitings

Siting of CO₂ pipelines is an issue that may have both federal and state dimensions. It is expected that many CCS injection facilities will be on or nearby the site of the emitting facility. In other cases, transportation of CO₂ by pipeline will be necessary. Pipeline siting could raise a number of legal issues at both federal and state levels. There is no federal agency that issues permits for CO₂ pipelines for energy regulatory purposes. The Federal Energy Regulation Commission (FERC), for example, does not exercise jurisdiction to issue permits for liquid pipelines, and CO₂ is expected to be transported from power plants and large industrial facilities in liquid form. However, other agencies review linear facilities for effects on the environment, navigation,

species, cultural and historic resources, and other issues. Issues related to pipeline approvals will need to be resolved to ensure that greatly expanded pipeline transmission of CO₂ for CCS can become available.

At the federal level, the siting of linear facilities most often raises issues under the Clean Water Act, the Rivers and Harbors Act of 1899, the National Environmental Policy Act, and the Endangered Species Act. Any number of other federal statutes may apply, depending on the resources affected by or near the facility.

Facilities that impact waters may require permits from the Army Corps of Engineers under Section 10 of the Rivers and Harbors Act of 1899, Section 404 of the Clean Water Act, or both. The Rivers and Harbors Act is intended to prevent obstructions to true navigable waters, and permits are generally granted upon meeting certain public interest criteria. The Clean Water Act covers all waters of the United States, which includes not only navigable waters but also non-navigable tributaries and adjacent wetlands. Clean Water Act permits are granted based on more stringent criteria, such as a showing of no significant degradation, and carry a duty to mitigate unavoidable impacts. Typically, the Army Corps of Engineers issues joint permits when a facility requires them under both statutes.

Most pipelines of any length are likely to require a federal permit of some sort, which is likely to trigger the National Environmental Policy Act (NEPA) and the Endangered Species Act (ESA). NEPA requires an assessment of potential environmental, historical and cultural impacts arising from “major federal actions significantly affecting the quality of the human environment.” Permits for significant projects often require Environmental Impact Statements (EIS), the most thorough procedural review under NEPA, which can take years and cost millions of dollars. For example, the average time for the Federal Highway Administration to complete an EIS between 1995 and 2001 was 5.1 years. In cases of projects likely to have less significant impacts, an agency will perform a less rigorous Environmental Assessment (EA), which often will result in a Finding of No Significant Impact. Other federal actions not likely to have a significant impact are subject to a categorical exclusion.

The ESA directs Federal agencies to ensure that their actions do not jeopardize endangered or threatened species or destroy or adversely modify critical habitat. Federal permits implicating the ESA can require consultation with the U.S. Fish and Wildlife Service or the National Marine Fisheries Service to determine potential impacts on any listed species. This can take the form of a biological opinion rendered by one of the agencies. If impacts are shown, an Incidental Take Statement can be granted as a kind of limited exemption.

Even when there is no federal permit involved, the ESA bars actions that result in harm or harassment to listed species. In these instances, Incidental Take Permits are available, but generally take longer to obtain than Incidental Take Statements.

The Army Corps of Engineers issues two types of permits, individual and general, under both the Rivers and Harbors Act and the Clean Water Act. General permits are often used for pipeline or transmission line projects whose estimated impacts on waterways do not exceed a half-acre. General permits are issued by the Corps on a national scale and reevaluated every five years, at

which time a cumulative NEPA analysis is performed. As a result, NEPA requirements do not apply for each individual pipeline or transmission line project that is eligible for a general permit. However, Endangered Species Act requirements still apply.

The U.S. Department of Transportation (DOT) has primary authority to regulate interstate CO₂ pipeline safety under the Hazardous Liquid Pipeline Act of 1979. Under the Act, DOT regulates the design, construction, operation and maintenance, and spill response planning for CO₂ pipelines. DOT administers pipeline regulations through the Office of Pipeline Safety within the Pipeline and Hazardous Materials Safety Administration (PHMSA). PHMSA's rate regulation does not constitute a major federal action, and thus does not trigger a review of environmental impacts under NEPA. However, state environmental statutes modeled after NEPA potentially could be triggered if a CO₂ pipeline is built in conjunction with a new power plant.

If pipelines cross public lands, they are generally required to obtain right-of-way easements for areas under the jurisdiction of the Bureau of Land Management, Bureau of Reclamation, and the United States Forest Service. Granting of such easements is likely to implicate NEPA and the Endangered Species Act, as described above.

Pipelines crossing private lands raise other interesting issues. Such pipelines appurtenant to power plants that are part of a utility's retail rate base in retail-regulated states may or may not (depending on state law) qualify for a state certificate of public convenience and necessity. Pipelines transporting CO₂ from other facilities, such as merchant power plants or industrial facilities, would not be able to obtain a certificate of public convenience and necessity. The importance of this issue for pipeline siting is that such certificates carry with them the ability to exercise eminent domain authority, should an applicant be unable to arrange reasonable terms to cross a landowner's property. Thus, in many cases, landowners may be able to block the construction of CO₂ pipelines.

Pipelines for CCS purposes are a classic case of facilities that would be built for the public good, for which the exercise of eminent domain authority is appropriate. Policy makers at the state and federal level that promote carbon controls must recognize that in order to implement CCS, it is necessary to provide eminent domain authority for CO₂ pipeline construction. Federal eminent domain authority already exists for natural gas pipelines under Section 7 of the Natural Gas Act. While most states have authority to grant certificates of convenience and necessity for electric transmission lines, Congress provided the FERC with "backstop" siting authority, and with it eminent domain authority, in limited cases through a provision in the Energy Policy Act of 2005.

Long-Term Liability

Engineered and natural analogues to the underground injection and long-term storage of CO₂ suggest that it can be safely and effectively achieved at a large-scale, provided best practices are adhered to for well drilling and injection. The appropriate selection of a geologic storage site based on available subsurface information and use of a monitoring and remediation program to detect and address any potential release of CO₂ render the risks to human health and the environment comparable to current activities such as natural gas storage, EOR/EGR, and deep underground disposal of acid gas.

From a regulatory and policy perspective, the virtually indefinite timeframe in which CO₂ would need to be contained underground raises questions over who should be responsible for post-closure monitoring and who would be subject to liability in the event of an accident. In some cases, the project developer and/or operator may no longer exist, making it necessary to consider liability transfers to the state once a CCS site has ceased operation.

State government could be asked to grant indemnity for CCS-related activities. For example, the state governments of Texas and Illinois agreed to take title to the injected CO₂ and indemnified the FutureGen Industrial Alliance and its members from any potential liability associated with the CO₂.

At the federal level, one model for long-term indemnity is the Price-Anderson Act, which establishes a no-fault insurance program designed to indemnify the nuclear industry against liability arising from accidents. The Act caps accident liability at \$7 billion (approximately \$10 billion in nominal terms as of 2006), with three tiers of responsibility. Tier 1 requires individual nuclear plant operators to obtain primary insurance coverage up to a mandated level (as of 2005, \$300 million per plant). Tier 2 requires that each company contribute up to a statutory cap of \$95.8 million per reactor owned, with payments made by each company in the event of an accident capped at \$15 million per year until claims are met or the maximum individual liability has been reached. Tier 3 requires the federal government to backstop the remaining balance owed to claimants, once the caps are reached.

The UIC program mitigates risk to the public by setting forth criteria for financial assurance requirements. Operators of certain wells under UIC programs must demonstrate that they have adequate financial resources to close and abandon their injection wells if they cease operation, with the amount required a function of the estimated costs of plugging and abandoning the injection well.

Generally, a financial assurance requirement is designed to create incentives for project developers and operators both to undertake CCS projects despite potentially prohibitive risks of long-term, post-closure management and to design, site, and operate facilities in a manner that minimizes risk of injury to public health and the environment.

Federal UIC regulations do not address post-closure periods. At the state level, the period of responsibility post-closure typically runs for 30 years, depending on the type of well. The EPA is considering a 5-10 year range as part of its pending UIC rulemaking, acknowledging that deployment of CCS likely will be limited if too long a timeframe is provided.

REFERENCES

16 U.S.C. 1531 et seq.
33 U.S.C. 403.
33 U.S.C. 1344.
40 CFR 144.12b.
40 C.F.R. 144-148.

40 C.F.R. 270.60.
42 U.S.C. §300h(b)(1).
42 U.S.C. 4321 et seq.
42 U.S.C. 6903(5).
42 U.S.C. 6903(27).
49 C.F.R. § 172.101.
49 C.F.R. §§ 190, 195-199.
49 U.S.C. § 601.

Benson, Sally. “Lessons Learned from Natural and Industrial Analogues for Storage of Carbon Dioxide in Deep Geological Formations,” Report LBNL-51170, *Lawrence Berkeley National Laboratories* (2002).

Dahowski, R.T., et al. “A North American CO₂ Storage Supply Curve : Key Findings and Implications for the Cost of CCS Deployment,” *Proceedings of the Fourth Annual Conference on Carbon Capture and Sequestration* (2005).

De Figueiredo, Mark Anthony “Property Interests and Liability of Geologic Carbon Dioxide Storage,” *Massachusetts Institute of Technology Carbon Sequestration Initiative* (September 2005).

De Figueiredo, Mark Anthony. “The Liability of Carbon Dioxide Storage,” *Massachusetts Institute of Technology* (Feb. 2007).

Edison Electric Institute. Written testimony to the House Select Committee on Energy Independence and Global Warming (September 21, 2007).

Energy Information Administration (EIA), USDOE, “Annual Energy Outlook” (2007).

Energy Information Administration (EIA), USDOE, “Emissions of Greenhouse Gases Report”. <http://www.eia.doe.gov/oiaf/1605/ggrpt/index.html>.

Energy Information Administration (EIA), USDOE, “Existing Capacity by Energy Source”, Table 2.2; 2006. <http://www.eia.doe.gov/cneaf/electricity/epa/epat2p2.html>.

Energy Policy Act, sec. 1221 (2005); codified as Section 216 of the Federal Power Act.

Environmental Protection Agency (EPA), “Final Guidance—Using the Class V Experimental Technology Well Classification for Pilot Geologic Sequestration Projects—UIC Program Guidance” (UICPG #83) (2007). http://www.epa.gov/safewater/uic/pdfs/guide_uic_carbonsequestration_final-03-07.pdf.

Ide, S. Taku et al.. “CO₂ Leaking Through Existing Wells: Current Technology and Regulations,” *Proceedings of the Eight International Conference on Greenhouse Gas Control Technologies* (2006).

Intergovernmental Panel on Climate Change, “Special Report on Carbon Dioxide Capture and Storage”; 2005.

Karimjee, Anhar and Bruce J. Kobelski. “An Overview of Technical and Regulatory Considerations for Geologic CO₂ Sequestration,” (EPA).

Larson, Kreig. “The Road to Streamlining: An In Depth Look at the NEPA Process and Ways to Expedite It,” *Public Roads* (Jul./Aug. 2003).

National Energy Technology Laboratory (NETL). “Carbon Sequestration: CO₂ Storage,” www.netl.doe.gov/technologies/carbon_seq/core_rd/co2capture.html.

Office of Pipeline Safety. “Distribution, Transmission, and Liquid Accident and Incident Data” (2007).

- Pacala, Stephen and Robert Socolow. "Stabilization Wedges: Solving the Climate Problem for the Next 50 Years With Current Technologies," *Science*, 305 (2004).
- Parfomak, Paul W. and Peter Folger. "Carbon Dioxide (CO₂) Pipelines for Carbon Sequestration," *Emerging Policy Issues, Congressional Research Service* RL33971 (April 19, 2007).
- Sminchak, Joel and Neeraj Gupta. "Issues Related to Seismic Activity Induced by the Injection of CO₂ in Deep Saline Aquifers," *First National Conference on Carbon Sequestration, National Energy Technology Laboratory* (2001).
http://www.netl.doe.gov/publications/proceedings/01/carbon_seq/p37.pdf.
- Stevens, Jennie C. and Bob Van Der Zwaan. "The Case for Carbon Capture and Storage," *Issues in Science and Technology* (Fall 2005).
- Testimony of the Hon. Joseph T. Kelliher, Chairman, Federal Energy Regulatory Commission Hearing. To receive testimony on carbon capture, transportation, and sequestration and related bills, S.2323 and S.2144, United States Senate Committee on Energy and Natural Resources (January 31, 2008).
- Texas Natural Resources Code §§ 119.002(a) and 119.004(b)-(c)
- United States General Accounting Office, "Deep Injection Wells: EPA Needs To Involve Communities Earlier and Ensure that Financial Assurance Requirements Are Adequate," GAP-03-761 (2003).
- Wilson, Elizabeth, et alia. "Considerations for a Regulatory Framework for Large-Scale Geological Sequestration of Carbon Dioxide: A North American Perspective," *Proceedings of the Seventh International Conference on Greenhouse Gas Control Technologies* (2004).
- Wilson, Elizabeth J., et alia. "Liability and Financial Responsibility Frameworks for Carbon Capture and Sequestration," *World Resources Institute* (Dec. 2007).
<http://www.wri.org/publication/liability-financial-responsibility-carbon-capture-sequestration#>

Chapter Four

Plug-In Hybrid Electric Vehicles and Coal -Based Power Plants with Carbon Capture and Storage

The current dependence of the United States' transportation sector on petroleum poses a number of public policy challenges. The current import level of over two-thirds of the country's petroleum supply has been characterized as symptomatic of an "addiction," creating both economic and geopolitical uncertainty. Conventional vehicle usage has environmental implications both for conventional pollutants (principally nitrogen oxides and hydrocarbons as precursors to particulate matter and ozone) and greenhouse gas emissions. Maintaining the highway and road systems entails substantial infrastructure costs. However, the economic, societal, and lifestyle benefits of the current transportation system, vehicle manufacture, and associated industries are undeniable and augur against any significant change in American driving habits for the foreseeable future.

FINDINGS

The National Coal Council finds the following. Each finding is of equal importance.

1. The combination of Plug-in Hybrid Electric Vehicles (PHEV) and coal-fueled electricity with carbon capture and storage (CCS) is an attractive way to use coal as a transportation fuel from economic, energy security, and environmental perspectives. If the electricity were generated in coal-fueled power plants with CCS, total fuel greenhouse gas emissions (per mile driven) for a PHEV would be reduced by 60 percent, compared to a conventional vehicle (spark-ignition gasoline or diesel) or 37 percent compared to Hybrid Electric Vehicle (HEV). Even without CCS, CO₂ emissions for the combination of a PHEV and coal-fueled electricity generated in a state-of-the art power plant are about equivalent to those of an HEV, and less than for a conventional vehicle.
2. A PHEV charged with coal-based electricity displaces petroleum (two-thirds of which now is imported) with domestic coal as a transportation fuel. Replacing ~60 percent of the light- and medium-duty vehicle miles with PHEV miles by 2050 would reduce petroleum consumption by 3.7 million barrels per day.
3. PHEVs are not commercially available at present. GM announced its "Volt" PHEV concept car with a "market introduction date" of 2010, and Toyota, Chrysler, Nissan, and Ford also have PHEVs under development.¹ EPRI expects PHEVs to enter the commercial marketplace in 2010. The principal technical issue is the cost and performance of the PHEV battery, which is the subject of considerable federal and private R&D.
4. A major impediment to the commercial acceptance of the PHEV will be its initial purchase price, projected to be \$2000-3000 above the HEV price when introduced into the commercial market, principally because of the battery cost. This is offset to some extent by lower fuel costs, but the payback period might be 10 years or longer, depending on fuel, electricity, and vehicle purchase prices.

5. During its initial introduction, the electricity requirements for the fleet of PHEVs would be low and could be met by the existing generating capacity, in part because PHEVs would be charged most frequently at night when excess capacity is available. To put this in context, a single 600 MW power plant would generate enough electricity to supply two million PHEV40s.ⁱⁱ Various studies conclude that even with significant PHEV penetration, the incremental electricity demand is modest. For example, EPRI found from its modeling that replacing ~60 percent of the total light- and medium-duty vehicle fleet by 2050 would result in only a 7.8 percent increase in electricity demand.
6. Since its introduction in 1999 (through 2006) about 650,000 HEVs were sold in the U.S., and a similar pace of introduction of PHEVs would suggest that they would not create substantial electricity demand for a decade. The timeframes for the deployment of PHEVs in sufficient number to create the demand for new coal-fueled power plants, and the deployment of CCS-equipped coal plants are relatively consistent within the 2020-2030 period. Because of the technical and economic difficulties in reducing CO₂ emissions from the transportation fleet, incentives for broad scale PHEV adoption can be highly cost-effective, on the order of \$3-5/tonne on an avoided-CO₂ cost basis.

RECOMMENDATIONS

As both advanced coal-based electricity generating technologies and the markets for alternative vehicles evolve, it is reasonable to begin looking at opportunities and incentives to encourage PHEV and CCS commercialization in tandem. This suggests that coupling incentives for incremental CCS deployment (i.e., above that needed to meet forecast electricity needs) with PHEV production could be an attractive policy option to reduce CO₂ emissions and introduce coal into the transportation sector. Therefore, the National Coal Council makes the following recommendations:

1. The Secretary should conduct research and development on coal-based electricity generating technologies, including CCS, to ensure adequate supplies of electricity to support the broad commercial implementation of PHEVs or other electric vehicles.
2. The Secretary should conduct research to reduce the cost and improve the performance of PHEVs, with particular emphasis on the cost, performance, durability, safety, and environmental impact of batteries.
3. The Secretary, working with other agencies and Congress as appropriate, should promote incentives for the deployment of advanced coal-based electricity generating technologies coordinated with the substantial market penetration of PHEVs or other electric vehicles, recognizing the economic, energy security, and environmental benefits of electrification of the transportation fleet.

INTRODUCTION

Reducing carbon dioxide emissions from the transportation sector poses unique problems. CO₂ emissions from the transportation sector have grown steadily since the EIA began reporting them

in 1990 and are forecast to continue to grow in the future. Although there have been increases in average vehicle mileage over the years and more improvement is expected because of recently enacted changes in Corporate Average Fleet Efficiency (CAFE) standards, increased motor vehicle miles driven have largely offset these reductions. Stationary sources like coal-fueled power plants are more amenable, at least in concept, to carbon capture and storage, but mobile vehicles have no easy “tail-pipe” solution to reducing CO₂ emissions. One alternative is to replace petroleum with a lower-emitting fuel, such as hydrogen or a biofuel. Hydrogen may be a long-term alternative, but faces both vehicle and fuel-delivery challenges. Biofuels are being used commercially now, but face at least two challenges. First, there is a limit to the amount of biofuels that can be produced. For example, replacing only 25 percent of the gasoline currently used in light-duty vehicles with ethanol from cellulosic crops would require 30-60 percent of all the cropland currently under tillage in the United States. Second, there is growing evidence that some biofuels, like ethanol or biodiesel, may have poor or negative carbon emission profiles; their environmental benefits may be low or nonexistent when full life-cycle impacts including land use are considered. The Plug-in Hybrid Electric Vehicle (PHEV) offers much greater potential to address both transportation fuel-supply security and environmental issues.

BACKGROUND ON PHEVS

A Plug-in Hybrid Electric Vehicle (PHEV) uses a combination of a liquid-fuel engine (gasoline, diesel, biofuel, etc.) and an electric motor for motive power. Like a conventional hybrid electric vehicle (HEV) such as the Toyota Prius, the PHEV stores electricity in an on-board battery, which is charged by the liquid fuel engine; the vehicle uses it to power the electric motor when the battery is sufficiently charged. Some of the vehicle’s kinetic energy can be captured regeneratively to charge the battery when the vehicle is in use. However, unlike the HEV, the PHEV can also charge its batteries directly from an external electricity source. This makes it possible for the PHEV to operate over some mileage range without running the liquid-fuel engine. Current prototype PHEVs and future commercial models are projected to have electricity-only ranges of 10 to 40 miles. If driven beyond this range, the external charge is depleted and the PHEV operates like a conventional HEV. Initially, the PHEV operates as an electric vehicle, but when its state-of-charge (SOC) drops to some lower threshold, it operates as a conventional hybrid vehicle and can be refueled from any suitable liquid-fuel source.ⁱⁱⁱ This gives the PHEV the advantage over a battery-only electric vehicle (BEV) in that its range is unrestricted by its electric charge capacity. In addition to these performance characteristics, the PHEV offers some other potential advantages including the convenience of home-recharging, resulting in reduced fill-ups, and improved acceleration because of the high torque of its electric motor.^{iv}

ECONOMIC AND ENVIRONMENTAL PERFORMANCE COMPARISONS

Both the HEV and PHEV achieve greater fuel efficiency than a comparable gasoline- or diesel-fueled conventional vehicle (CV). In the EPRI analysis, for example, a model-year 2006 gasoline CV is assumed to have a fuel efficiency of 24 mpg and an HEV has a fuel efficiency of 37 mpg. The PHEV has the same fuel efficiency as the HEV when operating on gasoline. However, because part of its travel is powered by electricity, the PHEV has two additional advantages.

First, depending on the relative prices of electricity and gasoline, a PHEV can be considerably less expensive in terms of fuel costs than an HEV or CV. For example, at a gasoline price of \$3/gallon, a CV operating at 24 mpg would incur a fuel cost of \$0.125/mile, about 50 percent more than that of an HEV operating at 37 miles/gallon (\$0.082/mile). At a retail electricity price of \$0.085/kWh, a PHEV operating at 0.31 kWh/mile incurs \$0.026/mile in fuel cost when operating within its battery-only range. General Motors announced the “Volt” concept PHEV this year with a battery-only range of 40 miles, which for many urban commuters would be sufficient to accommodate most of their driving. In a major study released last year, EPRI estimates that a PHEV40 would have an electricity utility factor of 66 percent, based on average U. S. driving experience.^v That is, 66 percent of all U. S. vehicle miles driven by PHEV cars and light trucks would be in the battery-only mode. Under the assumptions above, a PHEV40 operating at a 66 percent utility factor would incur a combined fuel cost of \$0.045/mile. This translates to an annual fuel-cost saving of about \$450 compared to the HEV and almost \$1000 compared to the CV for a typical annual driving distance of 12,000 miles.

Second, the PHEV can reduce criteria pollutants (particularly NO_x and hydrocarbons, and to a lesser degree SO_x) and CO₂ emissions compared to a conventional liquid-fueled vehicle or an HEV. This “well-to-wheels” analysis accounts for emissions from both the vehicle and the power plant. The reduction in CO₂ emissions depends on the source of the electricity. For a non-CO₂ emitting electricity source such as nuclear or wind, CO₂ emissions are reduced approximately in proportion to the PHEV’s utility factor. However, even if the electricity is generated in a coal-fueled power plant, the lifecycle CO₂ emissions are lower than for a conventional liquid-fuel vehicle, and approximately equal to that of an HEV.

Vehicle/Electricity Source	Greenhouse Gas Emissions Relative to Current Conventional Vehicle (CV)	
	2010	2050
CV	1	0.82
HEV	0.66	0.47
PHEV, New Coal	0.68	-
PHEV, Advanced Coal	0.66	0.44
PHEV, Advanced Coal & CCS	0.36	0.29

Note: “New Coal” refers to a pulverized coal-fired power plant of the kind that is being built today. “Advanced coal” refers to a supercritical pulverized coal or IGCC plant.

Source: Calculations made from EPRI, “Environmental Assessment of Plug-In Hybrid Electric Vehicles—Volume 1.”

Table 4.1. Comparison of Greenhouse Gas Emissions between Vehicles

If the electricity were generated in a state-of-the-art, coal-fueled power plant (“New Coal”) without carbon capture and storage, the “well-to-wheels” greenhouse emissions of the HEV and PHEV are approximately equal—and about 1/3 less than for the CV. For the advanced coal-fueled plant equipped with CCS, the overall emissions profile depends on the percentage of CO₂

captured. For the CCS case in the table above, corresponding to a carbon capture of ~90 percent, the greenhouse gas emissions are about 2/3 less than that of the CV, and about 60 percent of the HEV. Assuming various improvements in vehicle and power plant performance, the relative ratios remain about the same.

In a separate study, Samaras and Meisterling modeled lifecycle greenhouse gas emissions for various vehicle and power plant scenarios, including a “carbon-intensive” scenario with power plant CO₂ emission approximately equal to that of a current coal-fueled power plant. They included GHG impacts from battery manufacture and considered other fuel options such as cellulosic ethanol. As shown in Table 4.2, the results are qualitatively similar to the EPRI results, and a number of other earlier studies. Regardless of the carbon intensity of electricity generation, the PHEVs emit less lifecycle greenhouse gases than conventional vehicles, and PHEVs are substantially less emitting than HEVs in a low-carbon intensity scenario which includes CCS for the coal sector. Samaras and Meisterling stress the need for early and sustained adoption of low-emitting technologies like coal-fueled power plants with CCS if these hypothetical benefits of PHEVs are to be realized.

Vehicle	Current US Electricity Generating Mix (670 g CO₂/kWh)	High Carbon Intensity Scenario (950 g CO₂/kWh)	Low Carbon Intensity Scenario (200 g CO₂/kWh)
CV	434	445	415
HEV	310	321	290
PHEV30	295	350	203

Source: Samaras and Meisterling

Table 4.2. Life Cycle GHG Emissions, g CO₂e/mile

In addition to the GHG benefits, replacement of CVs and HEVs with PHEVs also improves ambient air quality because while operating in the battery-only mode, the PHEV emits no NO_x or VOCs, which are precursors to air pollutants such as ozone and particulate matter (PM). In Volume 2 of the EPRI’s analysis, the increase in coal-fueled electricity generation was found to result in some increase in primary PM, but most regions of the country experience a reduction in ambient PM because of the significant reductions in secondary PM from lower vehicle NO_x and VOC emissions. Although fossil-fuel power plants emit NO_x and SO_x, which also are ozone and PM precursors, emissions of SO_x are capped nationally, and NO_x emissions are capped over much of the Midwestern and eastern United States, so they cannot increase regardless of the additional electricity demand that PHEVs might create. In addition to these caps, a collection of federal and state environmental regulations limit emissions of conventional pollutants from old and new electricity generating units, with some regulations requiring power generators to offset emissions by reducing an equivalent or greater amount of emissions from other sources.

ENERGY SECURITY ADVANTAGES AND ENERGY DEMAND

From a national energy security perspective, the PHEV has the potential of introducing the reliable supply of domestic coal into the transportation fuel market, displacing imported

petroleum. EPRI estimates in their “Medium PHEV Penetration” case that by 2050 petroleum consumption would be reduced by 3.7 MM Bbl/day if ~60 percent of the light vehicle fleet were PHEVs. The amount of coal needed to power a vehicle-mile is approximately half as much in the PHEV case than if the coal were converted to liquid fuel, because of the thermal efficiency of the conversion process. This means that the U.S. coal reserve base can be leveraged to a much greater extent to replace oil imports if used to power electric vehicles, such as PHEVs, than through conversion to liquid fuels. On the other hand, an important advantage of liquid fuels from coal is that the fuel can be used in the existing vehicle fleet, without the requirement for replacement with a new technology, which, as discussed below, represents a significant impediment for PHEVs. Liquid fuels also can be used in applications like heavy-duty trucks, navigation, and aviation which are not amenable to electrification.

The electricity demand increase required to support a significant penetration of PHEVs into the vehicle fleet is relatively modest. A single 600 MW power plant operating at 85 percent capacity factor would produce enough electricity to charge 2 million PHEVs driving 12000 miles/year at a 50 percent utility factor. EPRI modeled a case in which 40 percent of all on-road vehicles in 2030 are PHEVs, operating at a 50 percent utility factor (i.e., 20 percent of all highway miles are driven on electricity only) with a proportional decrease in petroleum demand. This resulted in a national increase in electricity demand of only 5.8 percent compared to a base case without PHEVs. This is consistent with the results of other studies. For example, Kintner-Meyer estimates that the existing electricity infrastructure could supply 73 percent of the current light-duty vehicle fleet, or 43 percent of the fleet if limited to overnight charging.

PHEV MARKET PENETRATION

In 2030, 40 percent of the light vehicle fleet will be about 140 million vehicles. For comparison, 656,000 HEVs (first introduced in 1999) were sold in the United States through 2006, with 252,000 sold in that year.^{vi} Therefore, a challenge to meeting a hypothetical scenario in which 20 percent to 80 percent of the vehicle fleet would be PHEVs is the introduction of an average of 7.5 million PHEVs per year between 2010 and 2030. The figure of 7.5 million vehicles is about half the number of total automobiles and light trucks sold annually at present. Whether that scenario might happen will be determined at least in part by the relative purchase prices and operating costs of PHEVs, HEVs, and conventional vehicles.

The cost and performance of PHEV is critically dependent on the development of suitable battery technology, with key features being battery size and performance, durability, safety, and the environmental impacts of battery manufacture and disposal. The Department of Energy is supporting research on improving battery technology through the Argonne National Laboratory, which has been designated as the lead national laboratory for the simulation, validation, and laboratory evaluation of plug-in hybrid electric vehicles and the advanced technologies required for these vehicles. For purposes of this discussion, suitable batteries are assumed to be available under the given cost and performance parameters.

The sticker price of a conceptual PHEV is greater than that of an HEV at present, and HEVs sell at a premium of about \$3000 to conventional vehicles. A recent analysis by the National Renewable Energy Laboratory (NREL) projects substantially greater incremental capital costs

for PHEVs well into the future. Figure 4.1 shows the composition of costs for a future PHEV40 powertrain, including battery improvements, adding up to \$10,000 more than for a conventional vehicle, and about \$7000 more than an HEV.

Vehicle Costs

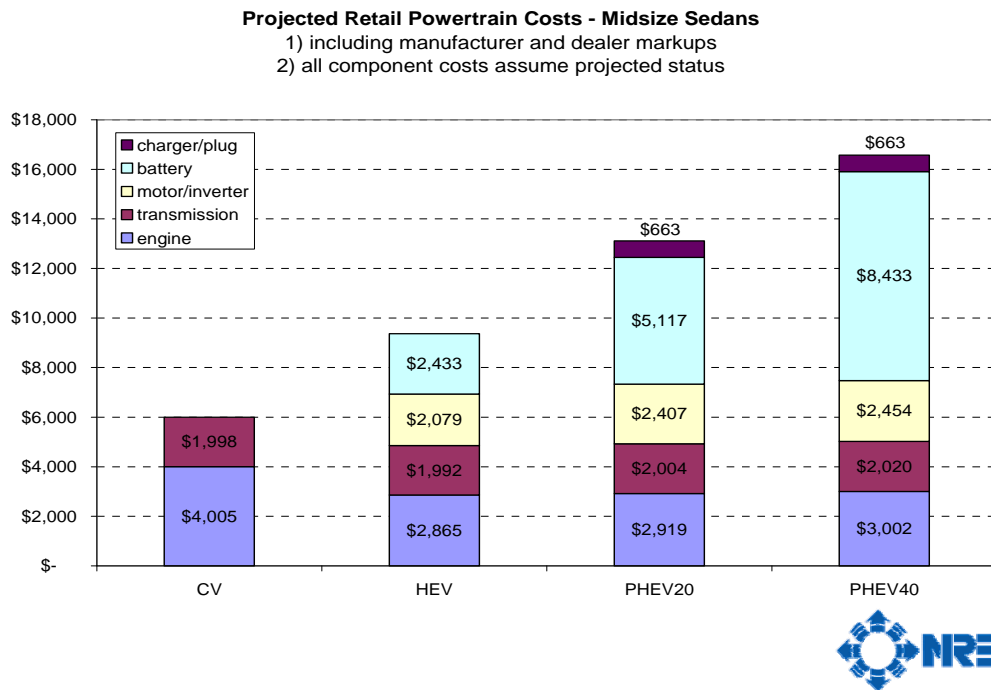

Source: National Renewable Energy Laboratory

Figure 4.1. Composition of Costs for a Future PHEV40 Powertrain

Based on these powertrain costs differences, NREL estimates a payback period (i.e, convergence of cumulative purchase price and fuel cost) of about 10 years for investment in a PHEV40 rather than a conventional vehicle. This analysis clearly is sensitive to vehicle purchase price and fuel cost assumptions, and NREL's projection of the relative purchase prices of these vehicles may be too pessimistic. EPRI estimates that, with further battery development and in mass production, a PHEV powertrain would cost \$2000 to \$3000 more than that of an HEV. The payback analysis also must consider possible differences in both gasoline and electricity prices in the future, perhaps because of including the cost of carbon emissions in the fuel price. The Table 4.3 summarizes the relevant assumptions for a range of vehicles and fuel prices.

	CV	HEV	PHEV (lower price)	PHEV (higher price)
Vehicle Price Difference	\$0	\$3000	\$6000	\$11000
Fuel efficiency, miles/gallon	24	37	37	37
Electric efficiency, kWh/mile			0.31	0.31
Utility Factor			66%	66%
Usage, miles/year	12000			
Fuel Price (Base/High), \$/gallon	\$3/\$5			

Electricity Price (Base/High), \$/MWh	\$90/\$150
--	------------

Table 4.3. Cost Considerations for Various Vehicles

Figure 4.2 depicts payback periods as a result of fuel cost savings for the difference in purchase prices of a CV, HEV, and PHEV using the assumptions tabulated above. The lines represent the cost difference over time by summing cumulative fuels and the initial purchase price differentials (assuming no difference in maintenance or other costs). The results show that under the higher purchase price, the PHEV does not break even with the CV for more than 10 years. Under the more optimistic purchase price assumption, the payback period for the PHEV compared to the CV is about seven years, somewhat longer than payback period than the HEV (about 6 years).

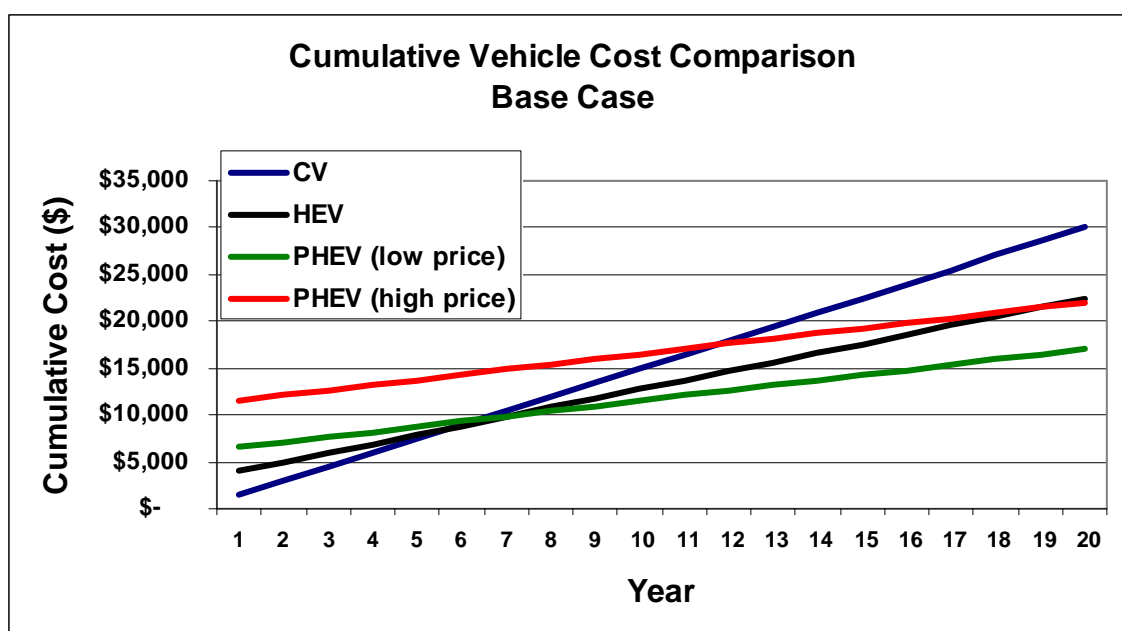

Figure 4.2. Cumulative Vehicle Cost Comparison Base Cost

As shown in the figure below, at the higher gasoline and electricity prices, the cumulative costs for the HEV and lower-cost PHEV converge with that of the CV in about 3.5 years. The electricity price increase has a relatively minor impact on the payback periods for the PHEV compared to either other vehicle, because electricity is a smaller component of the total fuel cost than gasoline.

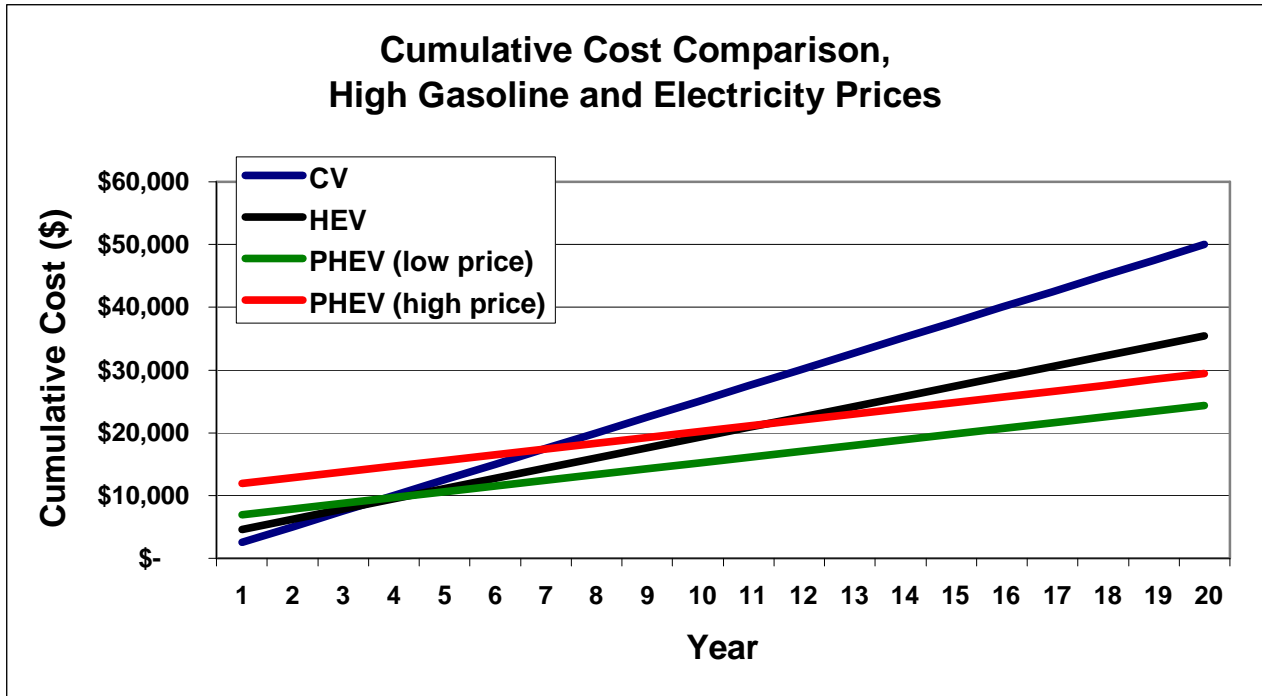

Figure 4.3. Cumulative Cost Comparison, High Gasoline and Electricity Prices

Marketing research indicates that the projected price differential between conventional vehicles and PHEVs would limit the market penetration to about 15 percent if environmental performance were the only discriminating factor between the two. However, half of the consumers in the study were will to pay a \$2000 premium based on environmental factors alone, without considering possible economic benefits of reduced fuel costs.

Amount Willing To Pay Extra For More Environmentally Friendly Vehicle

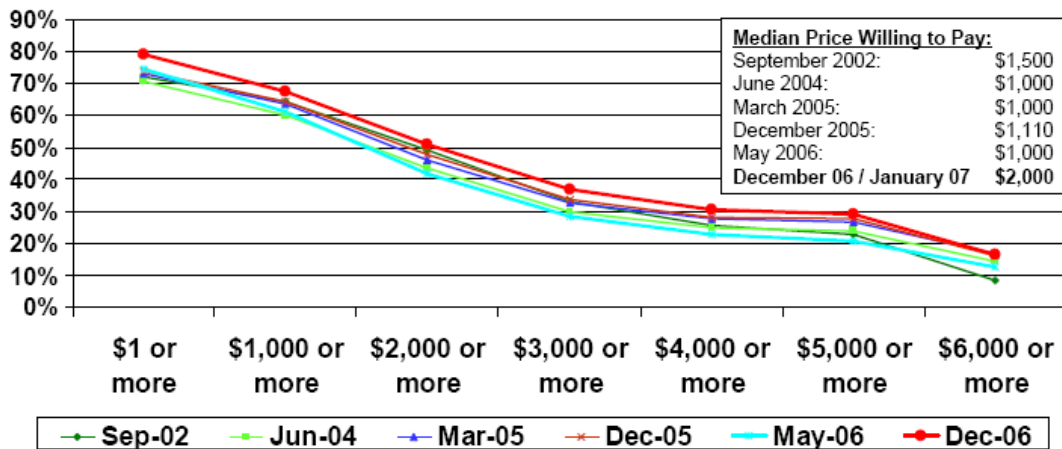

Figure 4.4. Amount Willing to Pay Extra for More

Environmentally Friendly Vehicle

introduction in the 2010 time frame, which is consistent with General Motors' announcement concerning its Chevrolet Volt vehicle. As the figure above shows, the key issues in PHEV commercialization are the cost and performance (weight, charging time, and battery life) of the battery.

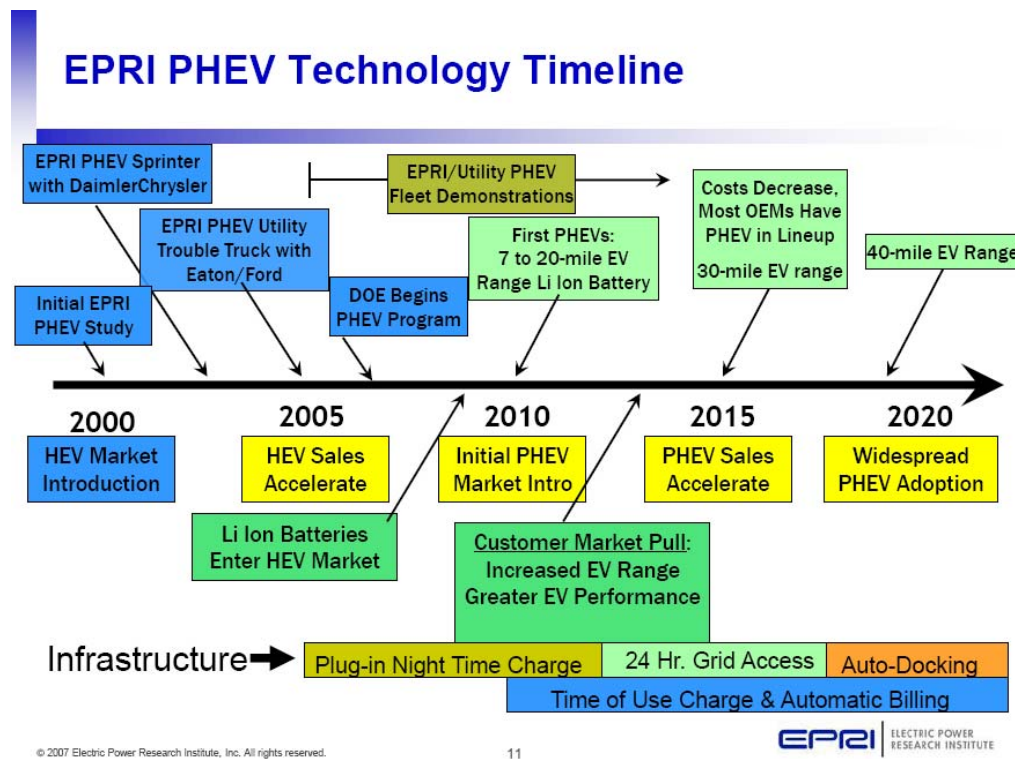

Figure 4.5. EPRI PHEV Technology Timeline

While the timeline for PHEV commercialization may appear somewhat protracted, it is not inconsistent with the timeline for the commercialization of CCS-equipped, coal-fueled power plants, which expected to be available for widespread commercial deployment in the 2020 to 2030 timeframe. As discussed above, the electricity demands for the initial introduction of PHEVs are likely to be modest, in part because the vehicles are expected to be charged most often at night when excess generating capacity is available. In the longer term, as PHEVs stimulate load growth, the opportunity exists to fulfill that need with new CCS-equipped coal-fueled power plants.

As discussed above, PHEVs will be more costly on an initial purchase price basis than CVs or HEVs, and consumers may be likely to discount the value of future fuel cost savings in making a purchasing decision. The purchase price difference may decrease as the technology matures, particularly if there is a substantial and growing market for the vehicles over the next two decades. Therefore, some level of financial incentive may be appropriate to create sufficient market demand for PHEVs to bring down the cost curve and attain consumer acceptance. Some consumers have been willing to pay the incremental cost of the HEV, perhaps in part because of environmental altruism or political chic, but certainly assisted in the decision by a federal tax credit approximately equal to the incremental cost of the HEV. However, Congress limited the full HEV tax credit to the first 60,000 vehicles produced by a given manufacturer. Six

manufacturers have qualified to date.^{vii} This makes the full tax credit applicable to 360,000 vehicles.^{viii} It seems likely that Congress would set some similar cap on any incentives for PHEVs. The question is: “What level of incentive is appropriate and affordable for the Federal treasury?”

An innovative and useful approach to answering this question was formulated by Constantine Samaras, currently doing graduate work at Carnegie Mellon University. He modeled the annual market penetration of PHEVs using the three adoption scenarios (20%, 62%, or 80% of light vehicle sales by 2050) set out in the EPRI study.^{ix} All PHEVs produced for some number of years after their initial introduction in 2010 would be eligible for a tax credit of \$1000, \$3000 or \$5000/vehicle under the low-, baseline-, and high-adoption scenarios respectively. This was presumed to stimulate the PHEV market sufficiently that unsubsidized sales in subsequent years would achieve the corresponding market penetration, leading to cumulative CO₂ emission reductions of 3 to 10 billion tonnes (compared to a fleet consisting of hybrids and conventional vehicles) as shown in the Table 4.4. In effect, the analysis assumes that providing the tax incentive initially for some number of vehicles (the first 10 million in this example) results in the emission reductions projected by EPRI for the full PHEV fleet through 2050. The tax revenue impacts in the table are based on the credit phasing out after its application to the first 10 million vehicles, which occurs 10 to 15 years after the inception of the program in 2010. The results show that the cost of the tax incentive is in the range of \$3-5/tonne CO₂ avoided (in nominal dollars). That is relatively inexpensive, compared to estimates of the cost of CO₂ emission reductions, particularly from the transportation sector, under various regulatory proposals.^x

PHEV Adoption Scenario	Tax Credit, \$/Vehicle	CO₂ reduction, billion metric tons	Revenue Cost, \$billion	Cost, \$/tonne CO₂	Credit Expiration Year*
Baseline	\$3,000	8.9	\$30	3.37	2021
High	\$5,000	10.1	\$50	4.95	2019
Low	\$1,000	3.4	\$10	2.94	2026

Note: In this analysis, the credit expires when 10 million qualifying vehicles have been sold.

Table 4.4. Revenue Impact of PHEV Tax Credit

REFERENCES

- Boschert, Sherry. "Well-To-Wheels Emissions Data for Plug-In Hybrids and Electric Vehicles: An Overview," <http://www.pluginamerica.org/images/EmissionsSummary.pdf>
- Mark Duvall. "Plug-in Hybrid Electric Vehicles: Jump Start to a Secure, Clean Energy Future," EPRI; May 7, 2007.
- Energy Information Administration (EIA), USDOE, "Annual Energy Outlook 2008"; February 2008.
- Energy Information Administration Office of Integrated Analysis and Forecasting, "Energy Market and Economic Impacts of S. 280, the Climate Stewardship and Innovation Act of 2007," July 2007.
- Energy Information Administration Office of Integrated Analysis and Forecasting, "Energy Market and Economic Impacts of S. 1766, the Low Carbon Economy Act of 2007," January 2008. [http://www.eia.doe.gov/oiaf/service/rpt/lcea/pdf/srioaf/\(2007\)06.pdf](http://www.eia.doe.gov/oiaf/service/rpt/lcea/pdf/srioaf/(2007)06.pdf)
- Environmental Protection Agency (EPA). "Inventory of U.S. Greenhouse Gas Emissions and Sinks: 1990-2005," USEPA #430-R-07-002; April 2007.
- EPRI. "Environmental Assessment of Plug-In Hybrid Electric Vehicles – Volume 1"; <http://www.epri-reports.org>. (Co-authored with the Natural Resources Defense Council).
- EPRI, "Environmental Assessment of Plug-In Hybrid Electric Vehicles – Volume 2," <http://www.epri-reports.org>. (Co-authored with the Natural Resources Defense Council).
- Fargione, Hill, Tilman, Polasky, and Hawthorne. "Land Clearing and the Biofuel Carbon Debt," *Science*; February 7, 2008.
- Kintner-Meyer, M., K. Schneider, R. Pratt. "Impacts assessment of plug-in hybrid vehicles on Electric utilities and regional U.S. power grids, Part 1: Technical analysis," Pacific Northwest National Laboratory; 2006.
- Lemoine, D.M., D. M. Kammen and A. E. Farrell. "An innovation and policy agenda for commercially competitive plug-in hybrid electric vehicles," *Environmental Research Letters*, 3, January-March 2008.
- Markel, Tony. "Plug-In Hybrid-Electric Vehicles: Current Status, Long-Term Prospects and Key Challenges," *University of Colorado Sustainable Energy Course Lecture*, NREL; November 16, 2006.
- Samaras and Meisterling. "Life cycle assessment of greenhouse gas emissions from plug-in hybrid vehicles: Implications for policy," *Environmental Science and Technology* (in press).
- Simpson, Andrew and Tony Markel. "Cost-Benefit Analysis of Plug-In Hybrid- Electric Vehicle Technology" *22nd International Electric Vehicle Symposium Yokohama, Japan, October 25-28, 2006*, National Renewable Energy Laboratory.
- Synovate MotorResearch's Advanced Propulsion and Alternative Fuels Syndicated Study; May 2006, <http://www.sae.org/events/gim/presentations/2007miller.pdf>.

Chapter Five

Liquids from Coal

Based on the material presented in this chapter, a set of findings and corresponding recommendations for federal and state government actions has been developed to assist development and growth of the coal-to-liquids (CTL) industry. The findings and recommendations summarized below are believed to be keys to the success of a comprehensive national initiative designed to facilitate development of a CTL industry.

FINDINGS

The findings and recommendations are disaggregated into four categories: 1) Financial, 2) Research and Development, 3) Institutional and Regulatory, 4) Department of Defense (DOD)

5. Financial: The Safe, Accountable, Flexible, Efficient, Transportation Equity Act: A Legacy for Users, SAFETEA-LU 2005 extension, provides a \$0.50 per gallon excise tax credit for certain alternative liquid fuels, including CTL products. This incentive is scheduled to expire in 2009, before any major new CTL plants can be built. Its extension through 2020 will provide critically needed market incentives for CTL development. CTL plants, especially the first ones to be built, often face difficulty in raising the required private capital investment.
6. Research and Development: The robust research programs undertaken in earlier years to improve the chemistry of SNG production and the preparation of new products in downstream processes have been inhibited by the lack of federal programs to support research in coal chemistry. The nation has experienced a sharp decline in the number of researchers in this area as a result of the elimination of industrial coal research labs and the elimination of federal research support. Investments in research would bring about improved yields and products from coal-SNG processes.
7. Institutional and Regulatory: A clearly defined permitting process for CTL facilities will reduce the uncertainty, time, and cost required for permitting, while retaining regulatory process and oversight. In order to facilitate the rapid scale-up of CTL production capabilities in the United States, regulatory changes are necessary, and standardizing, simplifying, and expediting the permitting process is crucial. The “not in my back yard” mentality, often accompanied by costly time-consuming litigation and obstructionism, needs to be countered with legislation and leadership.
8. DOD Policies and Incentives: Total oil consumption by military forces is approximately 300,000 bpd, and through the development of BUFF specifications a substantial portion of this requirement can be met with domestically produced CTL fuels. DOD desires to enter into long-term contracts for the purchase of alternative fuels made in the United States from domestic resources. This is part of DOD’s Total Energy Development (TED) Program, the stated mission

of which is to “catalyze industry development and investment in alternative energy resources.” DOD fuels purchases under long-term contract can help establish a foundation on which to build a CTL industry, and can secure the high quality United States made CTL fuels desired by DOD.

RECOMMENDATIONS

The NCC makes the following recommendations, which correspond to the previous findings:

5. Financial: Congress should extend the \$0.50 per gallon alternative liquid fuels excise tax credit. Also, the federal government should provide assistance to industry to attracting private capital for new facilities by:
 - Providing for 100 percent expensing in the year of outlay for any CTL plant that begins commercial operation by 2020
 - Providing for a federal loan facility of \$100 billion with the ability to provide loan guarantees for the initial commercial scale CTL plants (see EPLaw2005, Title XVII)
 - Extending the CTL excise tax exemption to 2020 (Safe, Accountable, Flexible, Efficient Transportation Equity Act: A Legacy for Users SAFETEA-LU 2005 extension)
 - Extending the temporary expensing for equipment used in refining to 100 percent of any required additions to existing refineries needed to handle CTL products (EPLaw2005, § 1323)
6. Research and Development: The federal government should increase its support of SNG chemistry, and research should be directed towards improved conversion processes for CTL and CBTL in bench and pilot studies of catalysis, processes to minimize CO₂ production, and of different coal types. Research should also focus on the development of alternative products from SNG chemistry, such as SNG, chemicals, and carbon products, the use computational chemistry to model catalysts, and assessment of the economics of emerging research.
7. Institutional and Regulatory: The federal government should develop clearly-defined permitting processes for siting, constructing and operating CTL plants. Federal agencies should work with local, state, and tribal agencies to establish a well-defined permitting process for the siting, construction, and operations of CTL plants. This should include all environmental impact documentation and permits related to air, water, land, product transport, mining, community impact, and safety and health. The federal and state governments should provide regulatory streamlining for the production of CTL fuels and should:
 - Standardize, simplify, and expedite permitting and siting with joint federal, state, and local processes, policies, and initiatives.
 - Make appropriate federal, state, and local government sites available for CTL plants, including Base Realignment and Closure (BRAC) military sites and disused heavy industry sites for which industries have foundered and the sites are now abandoned but could be reinstated as CTL sites.

- Encourage local leadership to modify approaches to zoning and other land use and business regulations to accommodate CTL activities.
8. DOD Policies and Incentives: The federal government should authorize and fund military purchases of CTL fuels under long-term contract. Congress should support DOD's TED program, including extending its long-term contracting capabilities from five years to as long as 25 years. Appropriations and necessary authorizations and funding for these programs should be given high priority.

INTRODUCTION AND RATIONALE FOR COAL-TO-LIQUID

Peak Oil

Oil Demand Exceeding Supply

World oil demand is expected to increase more than 40 percent by 2030, and to meet this demand, ever-larger volumes of oil will have to be produced. Since oil production from individual oil fields grows to a peak and then declines, new oil fields must be continually discovered and brought into production to compensate for the depletion of older ones. If large quantities of new oil are not discovered and brought into production somewhere in the world, then world oil production will no longer satisfy demand. That point is called the "peaking of world conventional oil production." When world oil production peaks, there will still be large reserves remaining. Peaking means that the rate of world oil production cannot increase; it also means that production will thereafter decrease with time.

Extensive exploration has occurred worldwide for the last 30 years, but results have been disappointing. If recent trends hold, there is little reason to expect that exploration success will dramatically improve in the future. This situation is evident in Figure 5.1, which shows the difference between annual world oil reserves additions minus annual consumption. The image is one of a world moving from a long period in which reserve additions were much greater than consumption, to an era in which annual additions are falling increasingly short of annual consumption. Peak oil does not imply that the world is "running out of oil;" rather it is the point at which the amount of oil production capacity that the world is losing due to depletion starts to exceed the rate at which upstream producers can bring new flows on stream.

Forecasting the Peaking of World Oil Production

Projections of future world oil production will be the sum total of 1) output from all of the world's then existing producing oil reservoirs, which will be in various stages of development, and 2) all the yet-to-be discovered reservoirs in their various states of development. This is an extremely complex summation problem, because of the variability and possible biases in publicly available data. In practice, estimators

use various approximations to predict future world oil production. The remarkable complexity of the problem can easily lead to incorrect conclusions, either positive or negative.

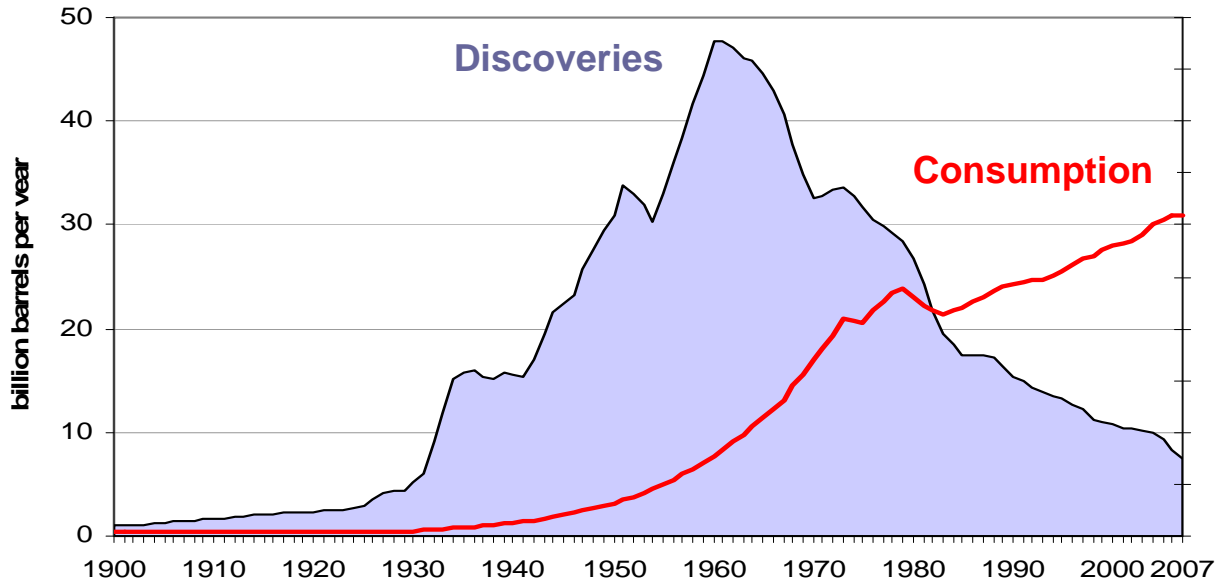

Source: ASPO—Ireland, *Newsletter*, August 2007; U.S. Energy Information Administration, *World Petroleum Consumption*, 2008; and Management Information Services, Inc., 2008.

Figure 5.1. World Conventional Oil Discoveries and Oil Consumption, 1900-2007

Forecasting peak oil is difficult due to the lack of reliable data and the fact that many nations treat their oil data as state secrets. Nevertheless, many credible analysts have in recent years become much more pessimistic about the possibility of finding the huge new reserves needed to meet growing world demand. Even many of the optimistic forecasts suggest that world oil peaking will occur in less than 20 years. Extensive research on peak oil has been conducted over the past decade, and various individuals and groups have used available information and geological estimates to develop projections for when world oil production might peak. A summary of recent projections is shown in Table 5.1.

The Changed World Oil Industry

Past oil production in North America, Europe, and some other regions of the world was generally managed by oil companies operating according to free-market values, which prized rapid, efficient, and profitable operations for the benefit of their stakeholders. Most forecasts of future world oil production assume that future world oil producers will be similarly motivated, and a major assumption is that geology will be the ultimate limiting factor. In other words, what can be produced in the future will

primarily be a function of the amount of oil that nature is capable of providing, which will at some point be limited, since petroleum is a finite resource. Parenthetically, a number of forecasters note that “above ground” influences could impose constraints, leading to lower future oil production.

Forecaster	Date
K. Deffeyes, (retired professor & retired Shell)	2005
M. Simmons, M. (oil expert & businessman)	2005
E.T. Westervelt, et al. (U.S. Army Corps of Engineers)	2005
Energy Watch Group (research organization)	2006
S. Hussein, (retired Saudi Aramco executive)	2007/08
S. Bakhtiari, (Iranian National Oil Co. planner)	2007/08
T. Boone Pickens (oil & gas investor)	2007/08
D. Goodstein, (Vice Provost, Cal Tech)	By 2010
C.T. Maxwell, Weeden & Co. (brokerage)	By 2010
D. Strahan (energy analyst)	By 2010
R. Bentley, (university energy analyst)	2010
C. Campbell, (retired oil company geologist)	2010/11
C. Skrebowski, (editor of <i>Petroleum Review</i>)	2010/11
L.M. Meling, (Statoil oil company geologist)	2011
X. Pang, (China Petroleum University)	2012
International Energy Agency	2012
Merrill Lynch (Brokerage/Financial)	2015
J.R. West, PFC Energy (Consultants)	2015
Volvo Trucks	By 2017
C. de Margerie (Oil company executive)	By 2017
Wood Mackenzie (Energy consulting)	By 2020
Shell	After 2025
CERA (Energy consulting)	After 2030
U.S. Energy Information Administration	After 2030
ExxonMobil	After 2030

Source: Management Information Services, Inc., 2008.

Table 5.1. Summary of Recent World Peak Oil Forecasts

The greatest above ground risk to future world oil production is almost certainly resource nationalism, wherein the relatively free-market values of the past have given way to large-scale government control of national resources. Where they exist, National Oil Companies (NOCs) dominate or completely control all oil production within their national borders, and some are establishing producing arrangements in other countries. The growth of resource nationalism has been so significant that the International Oil Companies (IOCs) today control only a small fraction of world oil reserves.

NOCs must deal with both political and business interests, and most were created to assume control of nationalized IOC assets and to implement government energy policies. NOCs provide revenues to their home governments and act as an engine of national economic development. In many cases, NOC public

service mandates have overwhelmed their commercial function; NOCs and their host governments often pay less attention to oil field operations and emphasize political and social responsibilities, leaving insufficient funds for oil field operations and maintenance, let alone investment in new production. In some countries, NOCs are managed by political appointees with no oil field experience. In such cases, political priorities can greatly overshadow operational requirements.

Thus, for the first time in history, most world oil production is no longer controlled by IOCs with their high levels of management skills, technology, financial strength, and profit motive. Now, a variety of local interests dominate world oil production through the medium of the NOCs. These NOCs possess varying technical expertise and priorities, and may not be willing or able to produce oil at the rates or volumes desired by the United States and other nations.

The Future World Oil Prices

As illustrated in Figure 5.2, oil prices have increased dramatically in recent years, and in early 2008 exceeded triple digits. Most forecasters believe that oil prices will remain high for the foreseeable future, and some are even predicting that oil prices will increase to the \$200 to \$300 per barrel range within the next decade.

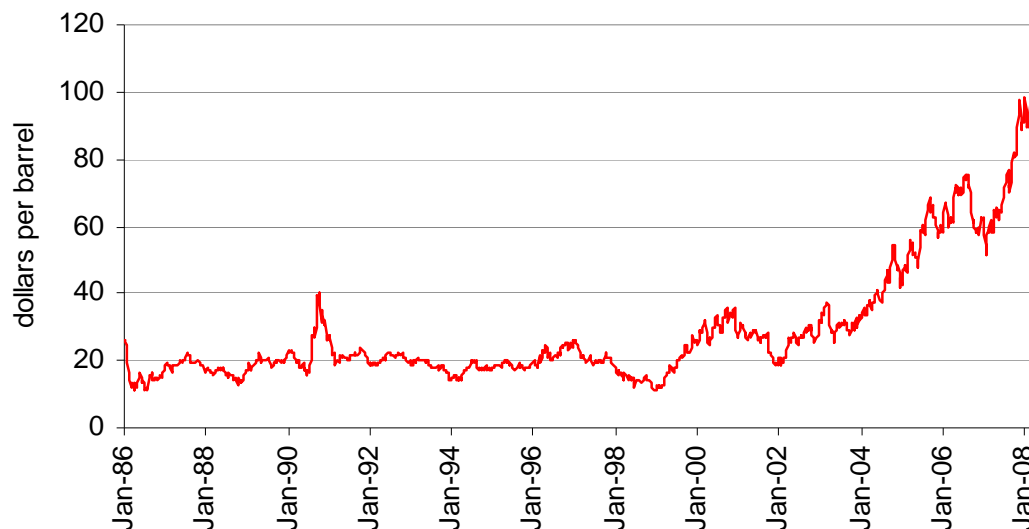

Figure 5.2. Weekly Price of West Texas Crude, 1986-2008

Energy Security

In his 2006 State of the Union message, President Bush stated the United States was “addicted to oil” and that the nation must reduce its dependence on oil imports. This will be very difficult, since: 1) The United States consumes more than 21 million barrels of petroleum products per day, over 60 percent of which is imported; 2) Oil accounts for 95 percent of the energy used in the U.S. transportation sector; 3) Over 7.7 million households, primarily in the northeastern United States, heat their homes with distillate fuel oil; 4) Refined petroleum products are the basic feedstocks required in the production of many manufactured products, such as plastics; 5) Oil refining produces asphalt and road oil and virtually all lubricants used in transportation and industry; 6) The U.S. agricultural system is highly dependent on oil to seed, grow, manufacture, preserve, and ship food products, and fertilizers, pesticides, herbicides, irrigation, and farm equipment all depend on oil; and 7) National security depends on the timely movement of military personnel and equipment, and DOD oil use totals 300,000 barrels per day (bpd).

Petroleum accounts for about 40 percent of U.S. energy consumption, and that percentage has grown consistently over the past two decades due to steady increases in fuel consumption. EIA projects this 40 percent figure will persist in American society through 2030 as the nation maintains its dependence on oil. Transportation accounts for more than two-thirds of U.S. oil consumption, and this portion is increasing. Further, 95 percent of U.S. transportation is dependent on liquid fuels, and this dependence will persist for decades to come.^{xi}

The United States faces the prospect of extended oil supply shortages, rising prices, continued large trade deficits, and economic and national security vulnerability unless industry and government act decisively to develop unconventional U.S. liquid fuel supplies, such as CTL. There are four factors that highlight U.S. vulnerability: 1) The nation is dangerously dependent on the OPEC cartel and other oil suppliers; 2) As noted, a growing number of experts, including some major oil companies, believe that within the next decade world conventional oil production will peak and begin a steady decline, and some contend that we have already reached the peak; 3) The United States faces unprecedented global competition for oil from China, India, and other nations, and this competition will grow more intense as supplies tighten and oil importing countries strive to secure oil supplies; and 4) The current U.S. liquid fuels infrastructure is vulnerable to natural disasters (as demonstrated with hurricane Katrina) and to terrorism. To insure against these risks and to provide for price stability and future economic prosperity and national security, the United States must reduce its growing dependence on foreign oil suppliers by producing its own liquid fuels using technologies such as CTL.

Superior Air Quality Values of CTL Fuels

The CTL industry has a 60-year world history, and the chemical science has been tested and is well-documented. CTL with CCS will have resultant life-cycle emissions comparable to the life-cycle emissions of gasoline and diesel currently in use. In addition: Co-generating and providing electricity for

the local community will decrease life-cycle CO₂ emission 35 percent; co-processing with 10 to 50 percent locally derived waste biomass can further decrease lifecycle plant CO₂ emissions to zero. CTL fuels are biodegradable, clean, clear, and colorless and provide an immediate replacement fuel for vehicles and aircraft. CTL emissions originate from a single source and can be controlled to levels below current petroleum refinery standards.

When compared to the diesel fuel currently used in vehicles, CTL-derived diesel has a lower emission profile. As shown in Figure 5.3, compared to typical diesel emissions the cleaner FT diesel will have an estimated 99 percent less sulfur, 90 percent less aromatics, 42 percent less hydrocarbons, 33 percent less carbon monoxide, 28 percent less particulates, 9 percent less nitrous oxides, and 5 percent less carbon dioxide.

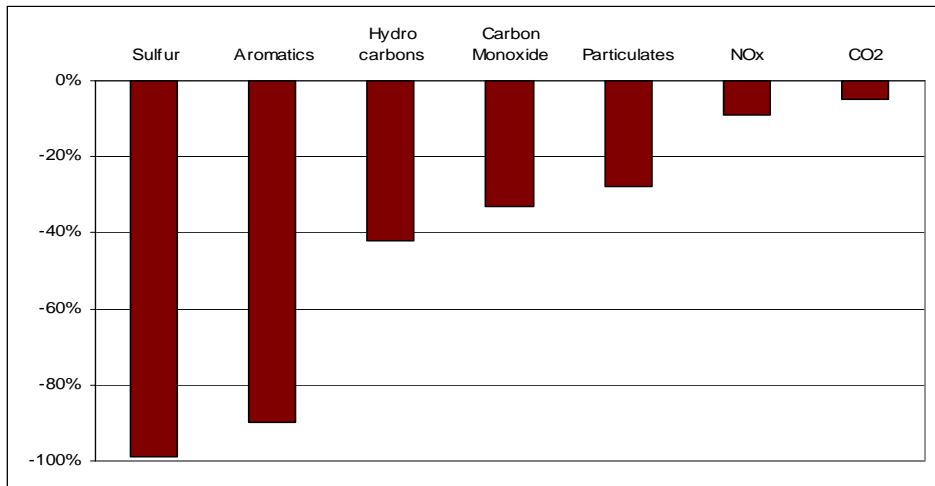

Source: Rentech, Inc., “Emissions and Environmental Performance of Coal-to-Liquids Fischer-Tropsch Fuels,” April 12, 2007.

Figure 5.3. CTL Emissions Reductions Relative to Typical Diesel Fuel

Further, as shown in Figure 5.4, utilizing advanced CCS technology, lifecycle CTL GHG emissions can eventually be reduced to levels below those of imported oil, which is a critical factor in securing federal government support and for prospective military use of CTL.

CTL Fuels Compatible with Existing Liquid Fuels Infrastructure

CTL produces ultra clean liquid fuels that are compatible with the existing transportation liquid fuels infrastructure. In addition, CTL can provide a drop-in fuel for military and civilian aircraft, which have highly specialized fuel requirements. Unlike biofuels, which are not compatible with

aircraft requirements, CTL fuels meet current aviation specifications and require no aircraft redesign. Coal-derived aviation fuels are presently being used in South Africa.

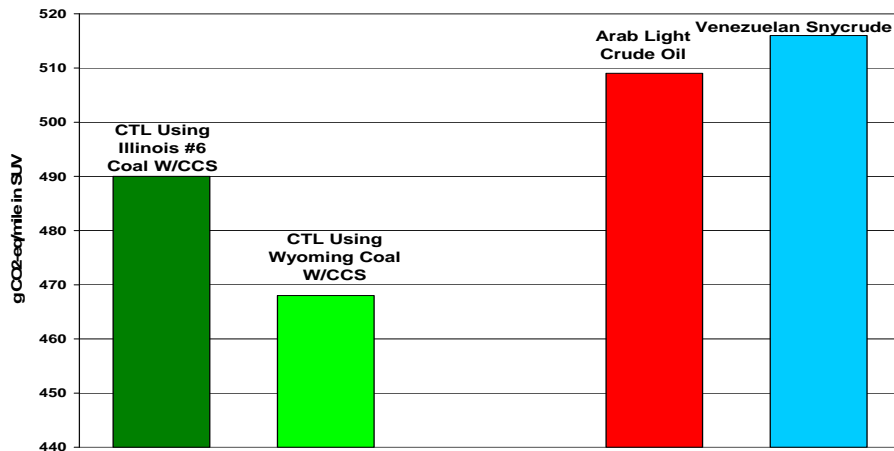

Source: John J. Marano and Jared P. Ciferno, *Life-Cycle Greenhouse-Gas Emissions Inventory for Fischer-Tropsch Fuels*, report prepared for the U.S. Department of Energy, National Energy Technology Laboratory, 2001, and Management Information Services, Inc., 2008.

Figure 5.4. Potentially Achievable Lifecycle GHG Emissions

CTL Potential in the United States

The United States is endowed with the largest coal reserves in the world, and recoverable reserves are estimated to be about 270 billion tons. In 2005, the United States produced 1.13 billion tons of coal, second only to China. Based on EIA's 270 billion ton reserve estimate, the United States has more than a 200-year supply of coal at current production rates. Even if production were to be doubled, the recoverable reserve base estimated by EIA would last for more than a century. Potential coal resources are even larger, and according to EIA: Estimated Recoverable Reserves (ERR) total 267.3 billion tons; the Demonstrated Reserve Base (DRB) totals 494.4 billion tons; identified resources total 1,730.9 billion tons; and total resources are 3,968.3 billion tons.

ERR is defined as the portion of the Demonstrated Reserve Base that will be recovered by mining. The DRB is comprised of "in-place" coal that meets certain criteria of measurement reliability, and is found within defined depths and in coalbed thicknesses considered technologically minable at the time of determination. An estimate is then made as to what portions of the demonstrated base are accessible and

economically recoverable by current mining methods under existing regulatory limits. EIA estimates that approximately 17 percent of the DRB is inaccessible for mining, and that 34 percent of the accessible portion would be unrecovered or lost during mining, leaving 54 percent of the DRB as potentially recoverable. This equates to 268 billion tons of recoverable coal using the recent 494 billion ton DRB estimate.

Figure 5.5 presents a visual characterization of how coal resources are classified in the United States. From top to bottom, the pyramid represents reserves/resource estimates by diminishing degree of confidence in data reliability and mineability characteristics. The top two categories, “Recoverable Reserves at Active Mines” and “Estimated Recoverable Reserves,” are estimates of tonnage that is available to be recovered by current mining practices. The lower categories are estimates of “in-place” coal resources, before applying a recovery factor.

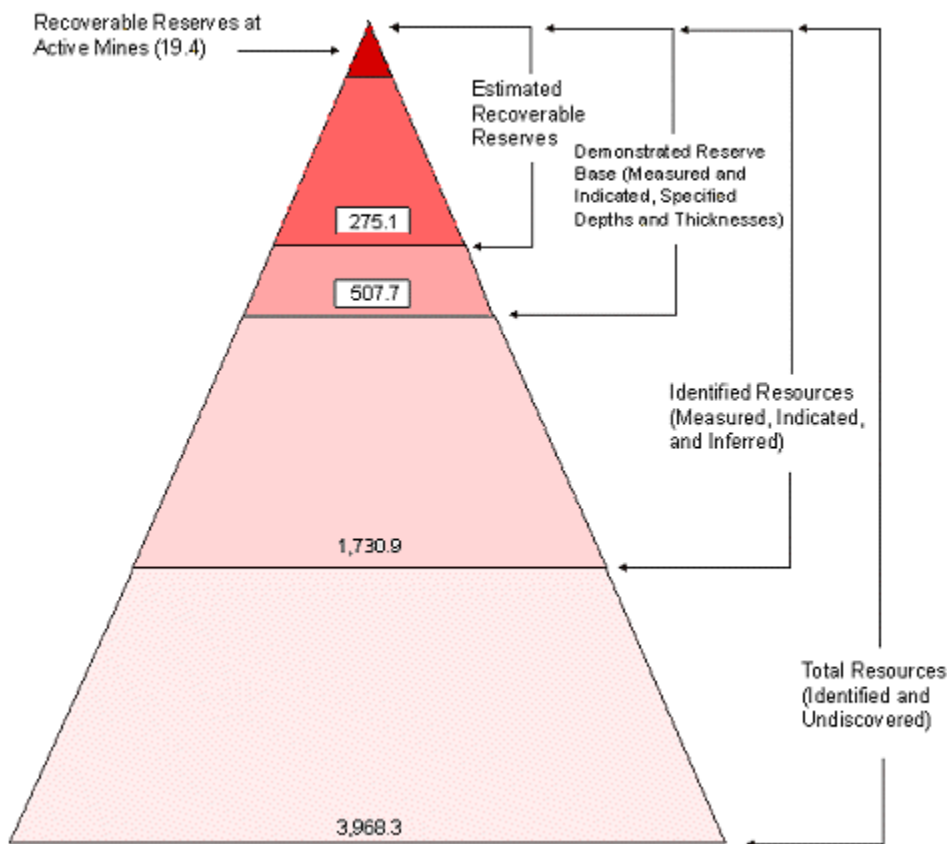

Notes: Resources and reserves data are in billion short tons. Darker shading corresponds to greater relative data reliability. The estimated recoverable reserves depicted assume that the 19 billion tons of recoverable reserves at active mines reported by mine operators to EIA are part of the same body of resource data. This diagram portrays the theoretical relationships of data magnitude and reliability among coal resource data.

Figure 5.5. Delineation of U.S. Coal Resources and Reserves (billions of short tons)

In summary, the United States has significant coal resources—far more than any other country—available for its domestic power generation and transportation fuel needs. Several recent studies of U.S. CTL potential have been conducted and, as shown in Figure 5.6, all estimate substantial potential over the next several decades.^{xiii} These include: 1) the SEB Study (July 2006) estimated 5.6 million bpd by 2030; 2) the USDOE/National Energy Technology Laboratory Study (July 2006) estimated 5.1 million bpd by 2027; the U.S. National Coal Council Study (March 2006) estimated 2.6 million bpd by 2025; and the USDOE Unconventional Fuels Task Force (November 2006) estimated 2.5 million bpd by 2035.

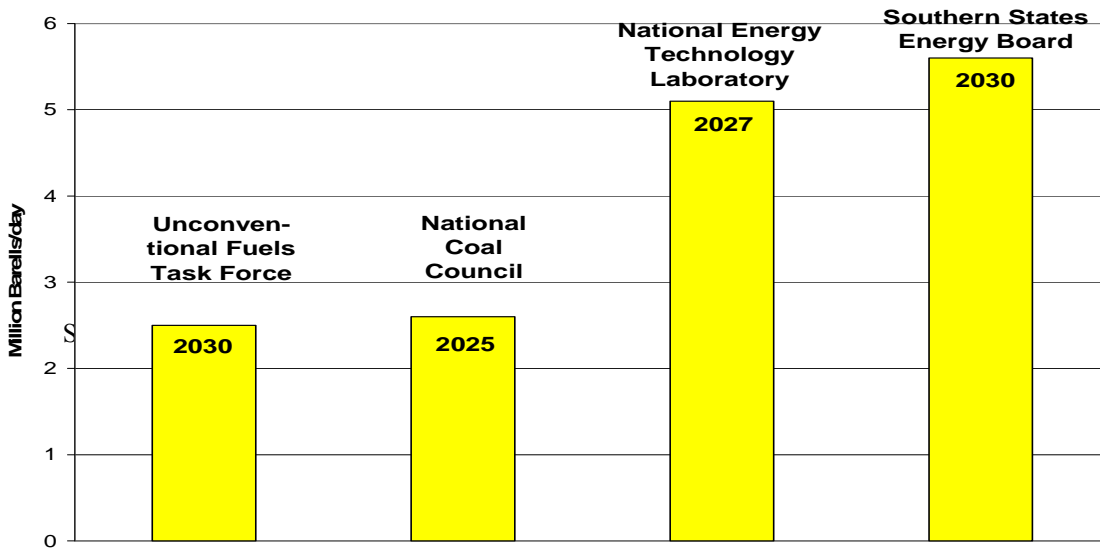

Figure 5.6. Estimates of U.S. CTL Potential

DOD, USAF, AND CIVILIAN AIRLINE INDUSTRY RATIONAL FOR CTL

DOD Initiatives

DOD currently uses nine different petroleum-derived fuels for its gas turbine and diesel engine applications, and has a goal of developing a single battlespace fuel for all of the services (see Figure 5.7). The Air Force consumes approximately 10 percent of the total jet fuel in the United States and realizes the significant advantages of CTL Fischer-Tropsch (FT) fuels over conventional petroleum-derived fuels in providing greater sovereign options. FT fuels can be manufactured to specifications that meet special needs or offer characteristics that are not available from petroleum-based fuels. The Navy is also interested in alternative transportation fuels for ships and aircraft from the standpoint of energy security. The Army is testing synthetic fuel in tactical vehicles and generators.

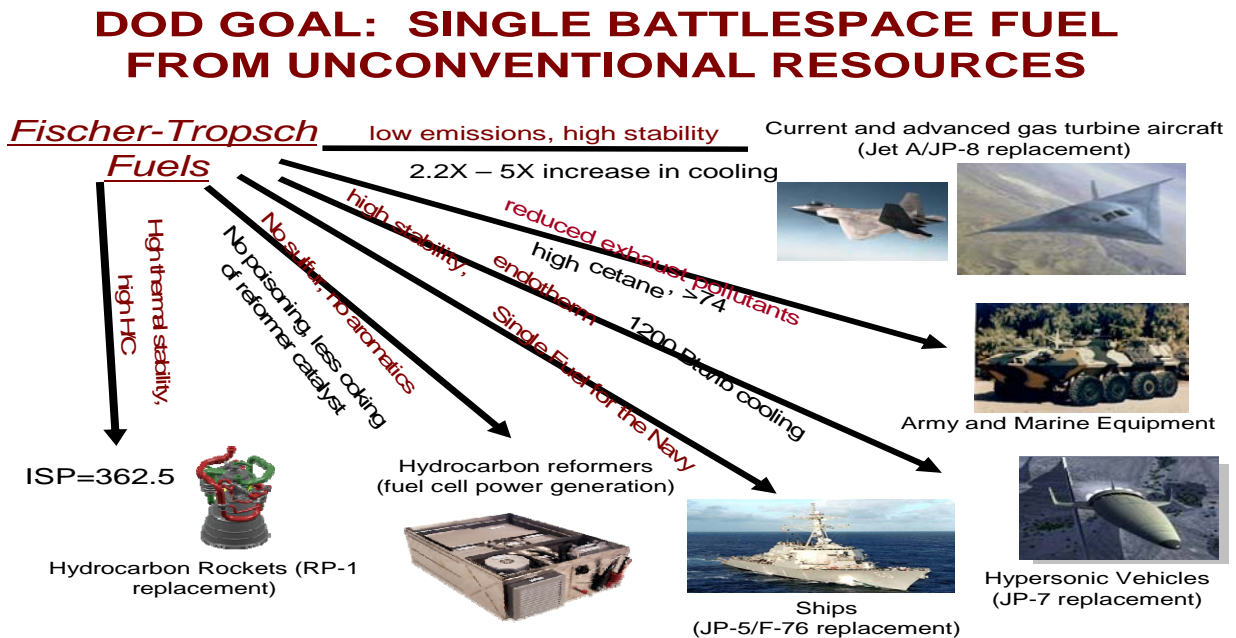

Figure 5.7. Fuel Objectives of Department of Defense

DOD purchases more jet fuel than any other organization in the world and plans to catalyze the commercial CTL industry to produce clean fuels for the military from secure domestic resources using environmentally sensitive processes. DOD concerns include ensuring secure and reliable sources of energy, reducing supply chain vulnerability, and obtaining cleaner, better (thermal stability, advanced engines) and fewer fuels (more than nine fuels are presently in use).

The Office of the Secretary of Defense Initiative is designed to: form partnerships with other government agencies, industry, and academia; catalyze industry development and investment in energy resources (Total Energy Development Program); and evaluate, demonstrate, certify, and implement turbine fuels produced from diverse energy resources (Battlefield Use Fuel of the Future Program). DOD feels that, relative to crude oil, the supply and cost of alternative fuel derived from domestic sources such as coal would be more insulated from geopolitical pressures, and is undertaking substantial research in alternative aviation fuels as a matter of national security, as well as cost. The assessment is being conducted by the Defense Energy Support Center (DESC), and the program will provide 100 million gallons each to the Air Force and Navy for testing on ships, aircraft, and other operational units. The alternative fuels would be blended with existing DOD fuel types, such as the Air Force's JP-8 and the Navy's F-76, in a 50/50 mixture or similar ratio.

Each military service prefers to maintain its current single-fuel policy, under which all vehicles are run with as similar a fuel type as possible. DOD officials want to use 50/50 blends widely for the service tests at first, to assess potentially retooling the ratio for optimum efficiency in the future. According to DESC, "Once the U.S. armed forces begins using alternative jet fuel, it would be only a short step to commercial use of the fuel as it would already have passed stringent testing by the military."

The DOD Clean Fuels Initiative involves a two pronged approach: 1) the Total Energy Development (TED) program will catalyze commercial production of fuels from alternative energy resources; 2) the Battlefield Use Fuel of the Future (BUFF) program will evaluate, demonstrate, and certify turbine fuels from alternative energy resources for use in tactical vehicles, aircraft, and ships.

The TED initiative is designed to: 1) use secure indigenous sources of energy, including coal, shale oil, and petroleum coke; 2) Minimize government funding and focus on qualification and certification; 3) Meet existing government mandates and executive orders to ensure environmental compliance; 4) Couple the program with advanced technologies to reduce the consumption of fuel; 5) Make a better fuel from coal, petroleum coke, and oil shale, and 6) Use environmentally sensitive processes to produce fuel. The BUFF program has the following elements: 1) Evaluation phase (2003–2009): \$42 million plus the cost of fuel to determine the characteristics of clean fuels, develop specifications and modeling and simulation tools, qualify fuel at the subcomponent level, and determine key logistic parameters and health and safety benefits; 2) ACTD phase (2007–2009): \$113 million plus the cost of fuel to demonstrate, validate, and certify clean fuels in tactical vehicles, aircraft, and ships; and 3) Implementation phase: \$15 million plus

the cost of fuel to implement the fleet Pacer programs in tactical vehicles, aircraft, and ships and to develop a full implementation plan based on commercial availability of clean fuels.

U.S. Air Force Initiatives

The federal government uses about 2 percent of the nation’s fuel. The Air Force uses more than half (nearly 53 percent) of all the fuel consumed by the federal government each year, and 80 percent of Air Force fuel requirements is aviation fuel (see Figure 5.8). For example, when an F-16 jet fighter engages its afterburners, it consumes 28 gallons of jet fuel per minute. The Air Force consumed over 3 billion gallons of aviation fuel in 2007 and the total Air Force bill for jet fuel in that year totaled more than \$5 billion. Current oil prices are higher than the 2007 average, and every increase of \$10 per barrel of oil increases Air Force fuel costs by \$600 million per year. For the Air Force, energy is an economic security issue: Fuel costs have more than doubled since 9/11, and the USAF is forced to repeatedly request supplemental appropriations from Congress to pay for increased fuel costs. Energy is also a national security issue, since flying hours cuts hurt training, combat readiness, and morale, and assured, domestic sources of supply are required, and a resilient and reliable energy distribution capability is needed.

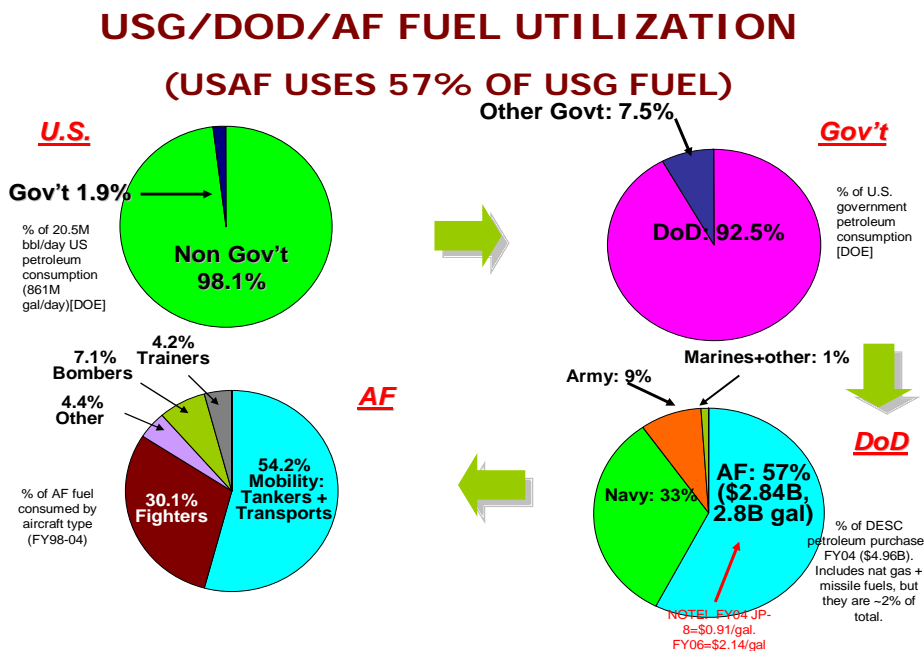

Figure 5.8. Use of Fuel By U.S. Government

USAF goals include accelerating development and use of alternative fuels, increasing the use of synfuels to 100 million gallons in the next two years, certifying the entire fleet on FT fuel by 2011, extending contracting authority to 25 years, and ensuring that 50 percent of its fuel will be synfuels by 2016. The demonstration of FT fuel in manned Air Force aircraft is progressing—it has been accomplished in a B-52 and certification is underway in other aircraft. The USAF plans to partner with industry to facilitate development of a U.S. synfuel industry and, based on

the results of its tests, plans are being developed for increasing the use of synthetic fuels in Air Force planes to 100 million gallons in the next two years.^{xiii} The USAF sees numerous advantages in CTL-derived fuels, including: 1) CTL fuel has benefits as an aviation fuel (see Figure 5. 9) including significantly reduced emissions, superior low-temperature properties, and excellent thermal stability at high temperature; 2) CTL fuel has environmental advantages, including emissions reductions relative to typical diesel fuel and a carbon footprint that can be less than imported oil; and 3) CTL can produce an alternate fuel, as aircraft have highly specialized demands for fuel, CTL offers an alternative aviation fuel that meets current specifications, and CTL can provide “drop-in” replacement for jet fuel. The Air Force also is partnering with airlines in the search for aircraft fuels not derived from petroleum.

FISCHER-TROPSCH FUELS BENEFITS

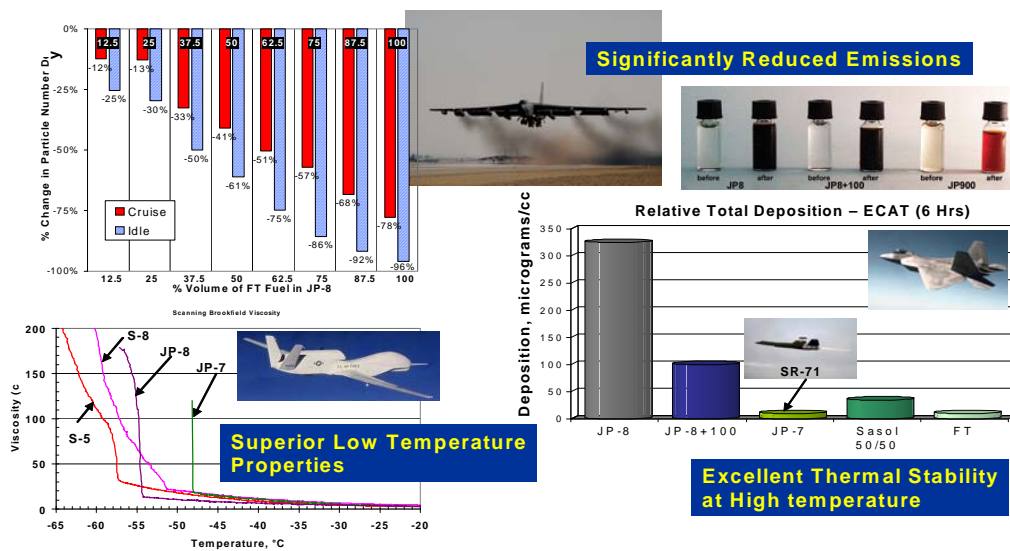

Figure 5.9. Benefits of CTL-Derived Fuels

The Civilian Aviation Perspective

The U.S. civilian aviation industry has many of the same energy concerns as DOD and the USAF; for example, aviation fuel costs have more than tripled in four years; for the first time in history, fuel has overtaken labor as the largest operating expense for most U.S. airlines; fuel now constitutes nearly 30 percent of total airline operating costs—twice the historical average; recent aviation fuel price increases and price volatility have reduced or eliminated profits for many airlines; and unlike other modes of transport, aircraft have no alternative source of energy. Commercial jets use a kerosene-type fuel, refined from oil, which must meet stringent quality specifications. Although the price of jet fuel is generally related to the price of crude oil, in recent years, jet fuel prices have risen even more rapidly than crude oil prices.^{xiv}

U.S. Airlines Costs in 2006

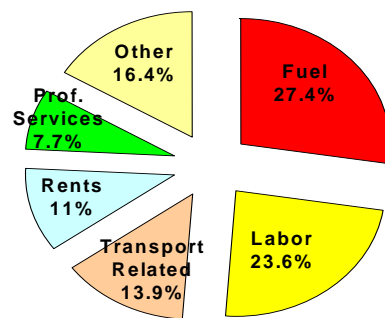

Figure 5.10 Distribution of Commercial Airline Operating Costs

Aircraft have highly specialized demands for fuel that exceed the requirements for gasoline and most other petroleum products. To withstand the high temperatures associated with jet engine combustion and minimize deposit buildup, jet fuel must be thermally stable. To prevent freezing at high altitudes, the freeze point of jet fuel must be much higher than that of other fuels and have a high flash point to avoid accidental combustion. In addition, current aircraft design requires fuel with high energy per unit weight and volume. Synthetic fuel using CTL technology offers much promise as a near-term alternative aviation fuel, as it can meet current specifications and requires little or no aircraft redesign. Thus, CTL provides the potential to furnish a “drop-in” replacement for jet fuel.

Synthetic aviation fuels derived from coal are currently being used in South Africa and are being tested by the U.S. Air Force, but further research is needed to ensure they are safe for long-term use in commercial aircraft. While the price point at which synthetic fuel becomes an economically viable alternative to petroleum-based jet fuel remains to be established, experts have indicated crude oil-price thresholds ranging from \$55 to \$70 per barrel.

To establish profitability, airlines try to manage the volatility of jet fuel supply and expense. As part of this effort, airlines are exploring alternative fuels, including those derived from coal, which could be developed for use in commercial aviation. The Air Transport Association of America (ATA) and individual airlines are monitoring and encouraging efforts by the U.S. government, airframe and engine manufacturers, and various academic institutions to bring CTL technology to the marketplace. The ATA is partnering with government industry, academia, and other interested parties to explore the operational, environmental, and financial implications of the use of alternative aviation fuels. Individual airline companies, such as FedEx and JetBlue, are also pursuing alternative liquid fuels initiatives.

U.S. commercial airlines consume approximately 1.3 million bpd of jet fuel, and total fuel consumption is forecast to increase more rapidly than average U.S. fuel consumption. By 2030, EIA projects that U.S. civilian aviation will be consuming 2.3 million bpd. To place this in perspective, EIA projects that in 2030 total U.S. domestic crude oil production will total about

5.9 million bpd. Thus, absent aggressive alternative fuel initiatives, within 22 years the fuel requirements of U.S. commercial aviation may comprise nearly 40 percent of total U.S. domestic crude oil production (see Figure 5.11).

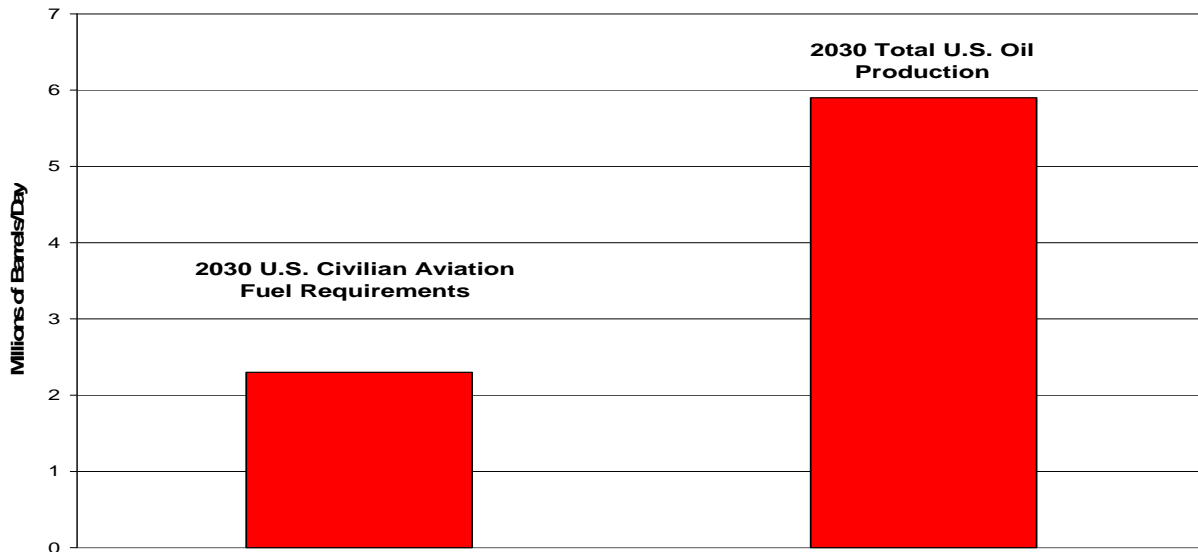

Source: U.S. Energy Information Administration and Management Information Services, Inc., 2008.

Figure 5.11. Comparison of Projected 2030 U.S. Civilian Aviation Fuel Requirements Compared to Total U.S. Oil Production

COAL-TO-LIQUIDS TECHNOLOGIES

Direct and Indirect Liquefaction

There are two basic technologies for producing liquid fuels from coal: Direct and indirect liquefaction. Direct liquefaction reacts coal with H_2 , sometimes in the presence of a liquid solvent, and aggressive reaction conditions are required (temperatures $> 400^\circ C$, pressures > 100 atmospheres, and sometimes an appropriate catalyst), and a synthetic crude is created that must then be refined to produce gasoline and diesel fuel. Indirect liquefaction involves gasification of coal to produce a SNG mixture of CO and H_2 , and the SNG is then converted into clean liquid fuels via Fischer-Tropsch (FT) synthesis.

Direct liquefaction (DCL) produces a synthetic crude that must then be refined to produce gasoline and diesel fuel, whereas indirect liquefaction involves gasification of coal to produce a SNG that is then converted into liquid fuels via Fischer-Tropsch (FT) synthesis or through use of a methanol-to-gasoline (MTG) technology. These are well-developed technologies that have been used to produce liquid fuels

from coal for more than five decades. The liquid fuels produced from direct and indirect liquefactions have different properties, with DCL products being more aromatic and denser and ICL being very paraffinic and of low density. Neither can achieve the current gasoline or diesel specifications without substantial upgrading.

Direct Liquefaction

DCL was originally developed for commercial application with DOE funding in the 1980s and was subsequently improved. Studies by DOE and the Shenhua Group of China have shown that the DCL technology has some advantages over indirect coal liquefaction (ICL) technologies. DCL has a lower investment per barrel of liquid product. DCL produces more liquid per ton of coal and has higher thermal efficiency. DCL has CO₂ emissions that are lower than those produced by ICL, and DCL liquids may be less expensive to produce than ICL products. However, DCL requires significantly more water than ICL and thus may not be viable in areas where water resources are scarce.

Indirect Liquefaction

Gas cleanup technologies are well developed and utilized in refineries worldwide, and both FT and MTG technologies have been well developed and commercially practiced. Importantly, coal liquids from gasification synthesis are of such high quality that they do not need to be refined. When co-producing electricity, coal liquefaction is a developed technology that is believed to be capable of providing clean substitute fuels at \$55 to \$70 per barrel.

There are two commercial processes for converting coal or natural gas to liquid fuels: the more widely known FT and the methanol-to-gasoline (MTG) route through methanol synthesis. While the FT route is generally for the production of diesel fuel or lubricants, the MTG process is primarily for the production of premium gasoline, and both involve three major steps in the process. The FT process includes SNG production, the FT step, and the product upgrading process. In contrast, the MTG process requires SNG production, methanol synthesis, and the MTG step. Since the product from MTG is primarily gasoline that can be directly marketed or blended with conventional gasoline, the MTG route requires minimal product refining. The feed methanol for MTG can be from coal or any other resources such as natural gas, heavy oil residues, petcoke, or biomass. These processes are outline in Figure 5.12.

Routes to Synthetic Transportation Fuels: FT, MTG

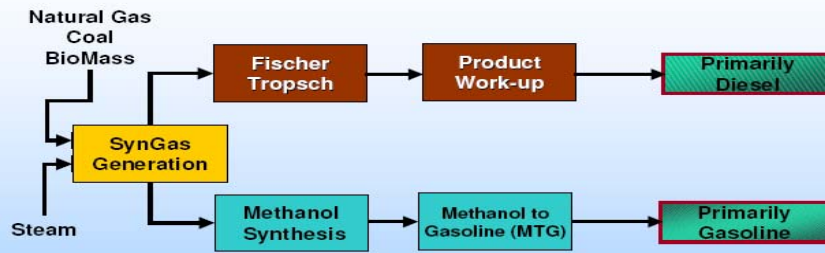

- Both are 3 Step Process
- Thermal Efficiencies are Essentially Governed by Thermal Efficiencies of the Syngas Production Process and Feed

Uhde
ThyssenKrupp

ExxonMobil
Research & Engineering

Indirect coal liquefaction using Fischer-Tropsch technology is a three-step coal-to-liquids process: 1) Coal gasification, 2) FT synthesis, and 3) FT product upgrading. Each process is described below.

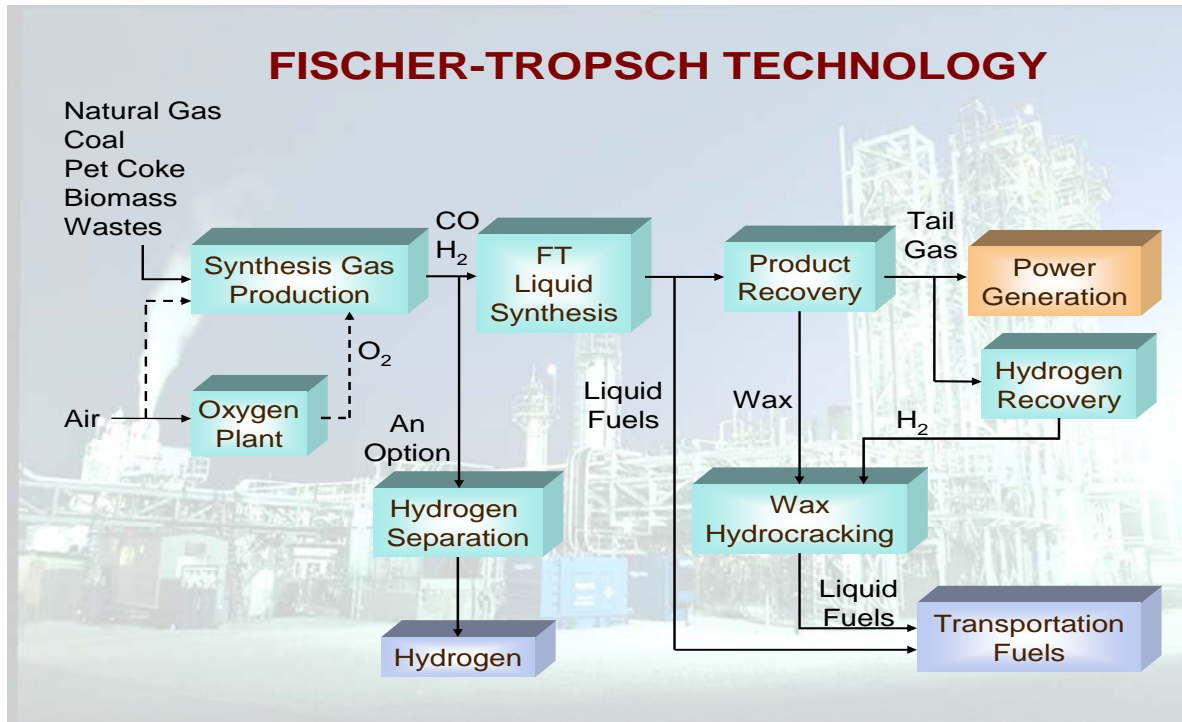

Figure 5.13. Fischer-Tropsch Technology

Gasification

Gasification is a process that, through heat and pressure, can convert coal (or virtually any carbon-containing material) into a gaseous product stream called “SNG.” SNG is made up primarily of hydrogen and carbon monoxide, and can be used in many ways, including the production of Fischer-Tropsch and other fuels, electricity, chemicals, fertilizers, hydrogen, CO₂ for Enhanced Oil Recovery, steam, and as a source of substitute natural gas. In addition to coal, possible feedstocks include petroleum coke and other residue from petroleum processes, biomass, and municipal and industrial waste.

The feedstock enters the gasifier, where it encounters steam and oxygen or air in a condition of high temperature and pressure. These cause the feedstock to be broken down into SNG and a solid ash waste product. The ash is typically removed from the bottom of the gasifier while the SNG enters a purification system. Gas cleaning removes impurities including sulfur, particulates, CO₂, and related products, the majority of which are saleable byproducts. Separation units also recover the hydrogen and carbon monoxide SNG.

Gasification technologies are believed to represent a next generation of solid-feedstock-based energy production systems. Gasification breaks down virtually any carbon-based feedstock into its basic constituents, and this permits the economic separation of pollutants and CO₂. The process also provides flexibility in the production of a wide range of products, as previously noted. The economics of gasification can be improved by fully utilizing and/or selling all outlet streams of the process, including byproducts from waste streams. Byproducts include pressurized CO₂, ash/slag, sulfur and/or sulfuric acid, hydrogen, and ammonia.

Fischer-Tropsch Synthesis

The Fischer-Tropsch process is named after F. Fischer and H. Tropsch, two German scientists who developed it in 1923. The process is a chemical reaction in which carbon monoxide and hydrogen (synthesis gas) are converted into liquid hydrocarbons of various forms at temperature using a catalyst. In an approximate ratio of two hydrogen molecules to one carbon monoxide molecule, the synthesis gas is sent through an FT reactor containing a catalyst where the SNG is converted to a range of hydrocarbon products, particularly naphtha, diesel fuel, jet fuel (kerosene) and wax. The wax can be inexpensively upgraded into additional diesel fuel, jet fuel, naphtha, and other products. FT reactor product yields depend on pressure, temperature, feed gas composition, catalyst type, catalyst composition, and reactor design.

There is both a low-temperature FT process (200-240 °C) and a high-temperature process (300-350 °C). High-temperature FT is capable of making a good grade of gasoline, which the South African company Sasol does on a large-scale basis. Low-temperature FT is generally used to make diesel and jet fuels, with a naphtha fraction also resulting.

Fischer-Tropsch synthesis makes a large amount of heat from the highly exothermic synthesis reactions, and produces the by-products CO₂ and water. It is necessary to keep the FT reaction temperature within a relatively tight band of tolerance, and temperature is the key FT reactor design parameter.

The hydrocarbon gasses coming out of the FT unit are recycled back as FT reactor feed, after removing the CO₂. The liquids are separated into diesel fuel and naphtha using a simple atmospheric distillation process, and the wax material is sent to a hydrocracker where the wax is converted into naphtha and diesel fuel, with some hydrocarbon gases also resulting, which are also recycled.

Fischer-Tropsch fuels are ultra-clean, bio-degradable, essentially zero sulfur, and have low particulate and NO_x emissions profiles. FT diesel and jet fuels have performance characteristics superior to their conventional distillate counterparts, and zero sulfur gasoline also can be

produced. Increased performance from FT fuels translates to lower emissions per mile traveled (including CO₂).

Methanol-to-Gasoline Technology

MTG technology is commercially proven and was originally commercialized by ExxonMobil in New Zealand during the 1980s.^{xv} At a site that uses the MTG technology, a slurry mixture of coal (65 percent solid coal) and water is produced by wet milling or grinding once the coal has been received. The coal slurry is then processed in quench gasifiers using 98 percent pure oxygen from the air separation unit. A quench gasifier is a type of gasifier that uses water to cool the raw SNG produced in the gasification process; it produces raw SNG and a slag/black water by-product. The raw SNG is then cooled, quenched, and scrubbed using water, and the slag/black water by-product is sent to a clean-up unit for further processing. The separated slag by-product is a glassy material that does not generally break down or seep into the soil and constitutes non-hazardous waste under current federal environmental laws.

The raw SNG produced in the coal gasification step is then delivered to a conditioner using a mercury absorber, a carbonyl sulfide hydrolysis reactor, an acid gas removal unit, and sulfur beds to achieve the desired SNG feed specification required for the SNG conversion. Carbon dioxide can also be removed, dried, channeled, and pressurized, and used in the EOR market.

The SNG is compressed, purified, and converted to methanol. After compression, any remaining impurities are removed and the gas is then passed over a methanol synthesis catalyst and converted to methanol. The crude methanol is reduced in pressure to remove unconverted gases which are sent to the power block as fuel gas. The methanol exiting the synthesis unit is dehydrated and it then undergoes a series of reactions in the MTG reactors. The effluent is combined, cooled, and separated, resulting in raw gasoline. The raw gasoline is then treated to meet commercial specifications.

A commercial-scale MTG plant with a capacity of 14,500 bpd based on steam reforming of natural gas and subsequent methanol synthesis was built in Motunui, New Zealand in the mid 1980s as part of the New Zealand government's strategic energy supply plan. This plant, which was 75 percent owned by the New Zealand government and 25 percent by Mobil (now ExxonMobil), went on-stream in 1985 and operated successfully for ten years before it was converted to the production of technical-grade methanol. Throughout the 1990s, the focus turned away from MTG processing due to the prevailing low price for crude oil. However, the dramatic increase in oil prices in recent years has focused attention on the MTG process—mainly as part of a coal-to-gasoline (CTG) or biomass-to-gasoline plants.

Increasing Interest in Alternative CTL Technologies

Coal-to-liquids is a term originally used to describe the activity of making diesel fuel, jet fuel, gasoline, and naphtha either indirectly from gasifier SNG (carbon monoxide and hydrogen) through the FT process, or by direct liquefaction using a hydrogenation process. However, in recent years, the term has generally been expanded to cover a broader spectrum of liquid fuels and chemicals produced from coal by various processes. CTL products and projects can include FT liquid fuels and chemicals, direct liquefaction liquid fuels and chemicals, gasoline via the MTG route, LPG from coal, anhydrous ammonia, methanol, ethanol, and coal/water oil substitutes.^{xvi}

MTG is gaining popularity because associated capital and operating costs are similar to FT synthesis and downstream product upgrading, it is readily available, and the resulting product, gasoline, has a much larger market than diesel fuel, jet fuel, and naphtha from the FT process. However, one drawback to MTG is that it has a somewhat higher lifecycle CO₂ footprint than FT because the fuel efficiency of gasoline is not as high as FT diesel. Other emerging CTL technologies include the Haldore-Topsoe's TIGAS process that converts SNG directly to diesel and some gasoline through a methanol route, and several SNG technologies that produce ethanol. In addition, several companies are pioneering both chemical and biological (anaerobic) processes to convert SNG to ethanol, with low cost results indicated.

Comparison of FT and MTG

FT and MTG are the two major technologies for indirect coal liquefaction for the production of high-quality synthetic fuels. Both are essentially three-step processes; each step has been fully demonstrated on a commercial scale, and both are available from experienced process licensors.

The choice of technology depends primarily on the market application of the product. CTL via FT is being emphasized due to significant growth in the diesel market and the increasing stringency of environmental regulations for fuel products, which has opened up a large market potential for ultra-clean synthetic FT diesel. MTG, on the other hand, is of major interest in gasoline-dominated markets such as China, especially in remote locations, where MTG can supply high-quality gasoline direct to the local market. Another interesting option in MTG is the possibility for flexible production (co-production) of methanol or gasoline, thus allowing optimized adjustment of plant operation to the prevailing market environment. In sum, both the FT and the MTG technologies are viable alternatives in efficiently utilizing coal reserves, especially low-quality or waste coals, for the production of high-quality products.

CTL Plants in the United States and in Other Nations

The status of CTL plant development in the United States is summarized in Table 5.2 and Figure 5.14. The status of CTL plant development internationally is summarized in Table 5.3 and Figure 5.15.

Project Lead	Project Partners	Location	Feedstock	Status	Capacity (bpd)	Cost
American Clean Coal Fuels	None cited	Oakland, IL	Bituminous	Feasibility	25,000	NA
Synfuels, Inc.	GE, Haldor-Topsoe, NACC, ExxonMobil	Ascension Parish, LA	Lignite	Feasibility	NA	\$5 billion
DKRW Advanced Fuels	GE, ExxonMobil	Medicine Bow, WY	Bituminous	Permitting	18,000-20,000	\$2-5 billion
AIDEA	ANRTL, OPC	Cook Inlet, AK	Sub-bituminous	Feasibility	80,000	\$5-8 billion
Mingo County	Rentech	WV	Bituminous	Feasibility	20,000	\$2 billion
WMPI	Sasol, Shell, DOE	Gilberton, PA	Anthracite		5,000	\$612 million
Rentech/Peabody	NA	MT	Sub-bituminous/lignite	Feasibility	10,000-30,000	NA
Rentech/Peabody	NA	Southern IL Southwest IN Western KY	Bituminous	Feasibility	10,000-30,000	NA
Rentech	Kiewit Energy Co., Worley-Parsons	East Dubuque, IL	Bituminous	Construction (2010)	1,800	\$800 million
Rentech	Adams County	Natchez, MS	Coal/Petcoke	Feasibility	10,000	\$650-\$750 million
Rentech	Baard Energy	Wellsville, OH	Sub-bituminous	Feasibility	35,000	\$4 billion
Headwaters	Hopi Tribe	AZ	Bituminous	Feasibility	10,000-50,000	NA
Headwaters	NACC, GRE, Falkirk	ND	Lignite	Feasibility	40,000	\$3.6 billion

Table 5.2. CTL Activities in the U.S.

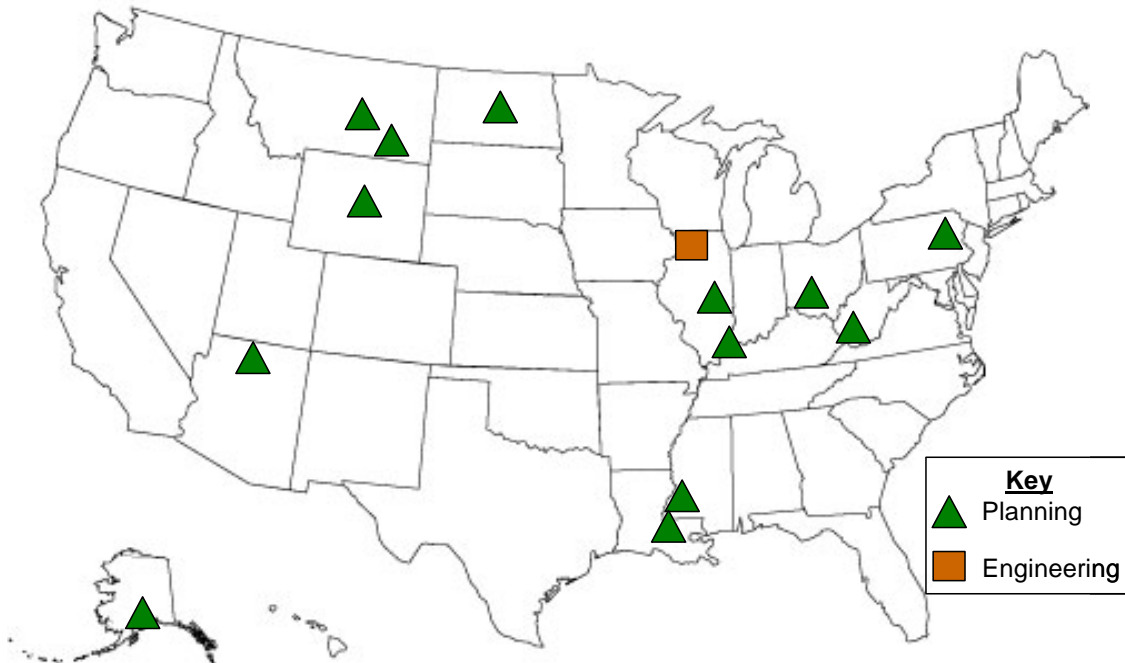

Figure 5.14. Status of CTL Plant development in the U.S.

Country	Owner/Developer	Capacity (bpd)	Status
South Africa	Sasol	150,000	Operational
China	Shenhua	20,000 (initially)	Construction Operational in 2007–2008
China	Lu'an Group	~3,000–4,000	Construction
China	Yankuang	40,000 (initially) 180,000 planned	Construction
China	Sasol JV (2 studies)	80,000 (each plant)	Planning
China	Shell/Shenhua	70,000–80,000	Planning
China	Headwaters/UK Race Investment	Two 700-bpd demo plants	Planning
Indonesia	Pertamina/Accelon	~76,000	Construction
Australia	Anglo American/Shell	60,000	Planning
Australia	Altona Resources plc, Jacobs Consultancy, MineConsult	45,000	Planning
Philippines	Headwaters	50,000	Planning
New Zealand	L&M Group	50,000	Planning

Table 5.3. CTL Activities Internationally

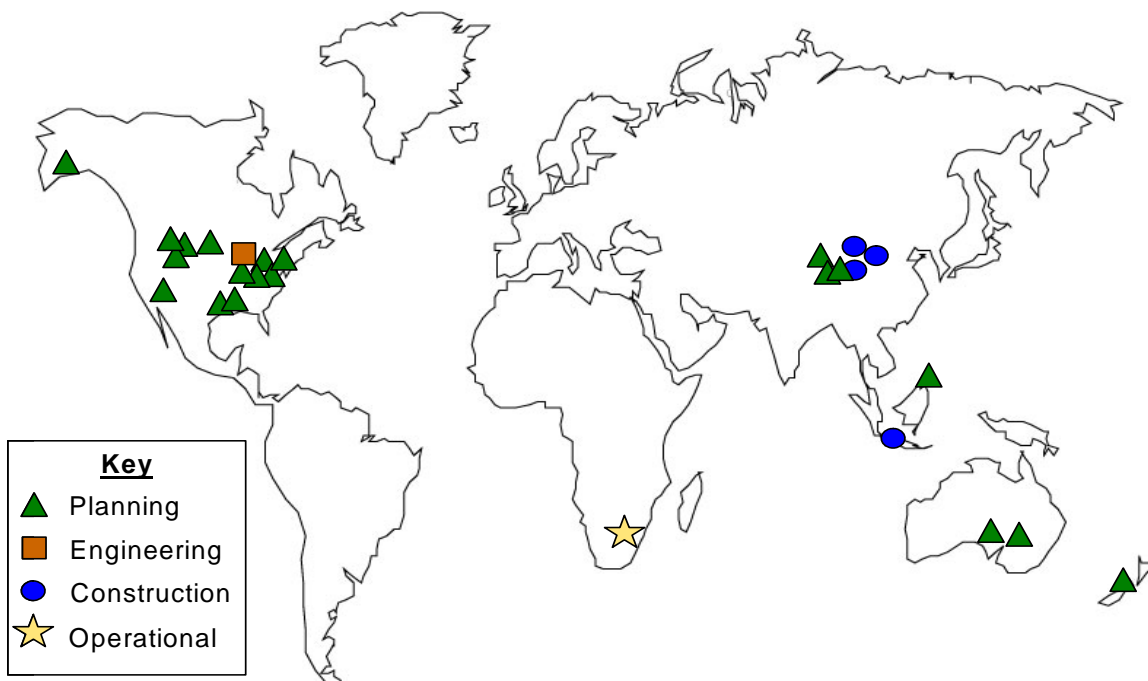

Figure 5.15. Status of CTL Plant Development Internationally

ECONOMIC AND FINANCIAL ANALYSIS OF CTL

Estimating the Cost of a CTL Plant

There are several factors affecting the assessment of CTL plant costs. These include: 1) There are few plants in operation, and therefore insufficient data exist on which to base cost estimates; 2) Costs will change significantly depending on whether it is the “first of a kind” plant or the “Nth plant;” 3) As plants are built, costs will tend to come down; 4) Plant costs will vary with plant size, location, capacity factor, climate, product slate, and coal type; 5) Plant commercial viability will be affected by whether or not there is an established infrastructure of labor force, roads, railway, power supply, etc.; 6) Differing assumptions may be made about the economic factors such as interest rates on any capital borrowed, the debt/equity ratio, how near to full capacity the plant will run, and other assumptions; and 7) Engineering estimates are often made by contractors and development organizations who do not have the perspective of a plant owner or investor.

Every CTL project has site-specific costs, depending on the nature and cost of the coal being used, infrastructure needed, local climate, availability of water, environmental regulations, CCS requirements and capabilities, and the range of products produced. Since any large CTL plant will involve substantial capital and operating costs, its profitability will be heavily dependent on the prices obtainable for the range of products produced. The financial assessment associated with the decision to build must assume a 6- or 7-year period for the necessary planning, permitting, siting, and construction of a plant, and a 20- or 25-year period of operation.

Investors thus need to assess the long-term relative costs and the security of the coal supply. There will also be considerations connected with supply security of the fuels themselves, and some key users (the military for example) may be prepared to pay a premium for a guaranteed supply of transportation fuel products. In addition, the need to add a CCS stage to the plant needs to be considered, along with a long-term supply of water at a stable cost. There may also be other changes in the regulatory background that impact the operation and costs associated with any CTL plant.

IEA has noted that the unit costs of CTL production remain high. According to IEA, at a steam coal price of \$20/t, CTL can be competitive with a crude oil price of \$40/bbl. The average production cost of synfuels would be about \$50/bbl. It should be noted that these estimates are two years old, and, as discussed in Section 3.C.5, costs for all aspects of CTL development (and all energy projects) have been increasing rapidly.

In 2006, IEA estimated that the capital cost of a CTL plant producing 80,000 bpd is about \$5 billion, compared with an equivalent gas-to-liquids plant which would cost less than \$2 billion. More recent

CAPEX estimates for a CTL plant are much higher—but the cost estimates for GTL plants have also increased substantially.

CTL cost assessments should also take into account the energy intensive nature of the technology, cooling water requirements, compliance with CCS mandates, availability of a substantial reserve of low cost coal, adequate supplies of low cost water, the existence of suitable and proximate CO₂ sequestration sites or EOR opportunities, and the availability of federal, state, and local government support.

The Cost of CCS

The economics of a CTL plant will be strongly impacted by future requirements for CCS. In terms of plant location, proximity to suitable CO₂ sequestration and storage sites such as depleting oil wells or exhausted natural gas reservoirs can help minimize costs. The Great Plains gasification plant is located 200 miles from an oil field in which much of the CO₂ produced is used for EOR and ten remains trapped in the strata. Great Plains receives a useful revenue stream from the operation, offset to an extent by the significant pumping costs and the capital cost of the pipeline.

CTL plants being considered today confront many of the same design dilemmas as coal-fired power plants when it comes to CO₂ emissions controls. Developers face major choices that will impact both siting and design decisions. Evaluating the cost of including CCS and comparing this with the costs that may be imposed by GHG emission control policies is a necessary exercise, even though the parameters are difficult to quantify. When compared with conventional power generation plants, the net cost of carbon sequestration from a CTL FT process is relatively low, since the process already involves the separation and capture of CO₂. Thus the marginal cost of sequestration arises only from that of compression, transportation, and appropriate storage. In a study by Olsen and Reed, which is based on one CTL plant design, the additional cost was estimated to be about \$14/t CO₂.

Studies of CTL Costs and Potential

In 2007, MIT assessed the potential costs and economics of CTL plants. The MIT study estimated that the capital cost of a synthetic fuels production facility is around \$53,000 per bpd of liquids output with no CO₂ capture, increasing to \$56,000 per bpd with CO₂ capture. The study assumed a 20-year plant life, a 3-year construction period, a 15.1 percent capital carrying charge factor on the total plant cost, a 50 percent overall thermal efficiency for the FT plant, and a 95 percent plant capacity factor. On the basis of these assumptions, the production cost of CTL FT fuels was estimated to be \$50/bbl without CO₂ capture and \$55/bbl with CO₂ capture. The United States consumes about 13 million bpd of transportation fuels. Thus, to replace just 10 percent of this would require over \$150 billion in capital investment, and about 250 Mt/y of additional coal production. This represents a 25 percent increase in coal production.^{xvii}

The prospective mandating of CCS for new CTL plants is estimated to increase the cost of the liquid fuels by about 10 percent. This relatively low additional cost is due to the fact that in oxygen-fed gasifiers it is relatively easy to separate the CO₂ formed from the SNG, and thus to capture and sequester it. Sequestration costs will be heavily dependent on whether there is a profitable use for the CO₂, as for enhanced oil recovery, or whether it is stored somewhere like a deep saline aquifer, where there is no immediate financial benefit, and where there will be ongoing monitoring costs to ensure that the CO₂ remains where it has been sequestered.

Economics will impact decisions regarding the CTL project site. Comparisons highlighting both the economies and disadvantages of scale were presented at an IEA CTL workshop in Paris. There are potential reductions in capital and operating costs on a bpd basis through economies of scale; however, the development costs prior to making the financial investment decision increase sharply. For example, they can increase from \$40 million for a 10,000 bpd plant to \$140 million for an 80,000 bpd plant.

In the MIT study, capital costs for a CTL plant are cited as ranging from \$42,000 to \$63,000/bbl/day production, depending on plant size and location. The FT section and associated equipment accounted for \$15,000 to \$35,000 of the costs. These figures compare with a typical capital cost of \$15,000/bpd output from a conventional crude oil refinery. Both the capital and operating costs of a CTL facility decline on a unit basis by about 35 percent when comparing a 10,000 bpd plant with one producing 80,000 bpd. This is clearly a significant cost reduction, and has influenced project development approaches. For example, Sasol has concentrated on economies of scale and has only evaluated plants producing about 80,000 bpd. However, more recent CTL plant cost estimates derived from industry data are much higher than the MIT estimates—perhaps by a factor of two. At the same time, as previously discussed, the costs for all types of energy and infrastructure projects have increased dramatically over the past two years.

A larger CTL plant requires a proportionately larger reserve of low-cost coal and water resources near the plant, and project financing becomes more difficult as the weighted average cost of capital increases. In addition, as noted, the development costs before the final investment decision is made are substantially higher for larger plants. These development costs include all the front-end engineering and design (FEED) costs, and take into account the necessary permitting. They provide a significant commercial disincentive, since these costs are not recoverable if the plant is not built.

A 2007 DOE study examined the technical and economic feasibility of a commercial 50,000 bpd FT CTL facility in the Illinois coal basin. The study assessed conceptual design development, process analysis, component descriptions, and capital and operating cost estimates, and conducted a comparative financial analysis. Major findings include: 1) The conceptual design evaluated is technically feasible using equipment that has been demonstrated at commercial scale, although no commercial CTL plants are currently operating in the United States; 2) Commercial-scale CTL plants using Midwestern bituminous coal represent promising economic

opportunities; 3) Plant capacity factors and EPC costs have a strong impact on the financial analysis, but even with major changes to these inputs positive financial returns are possible; 4) Project viability depends heavily on crude oil price scenarios; and 5) Policy actions impact expected ROIs and federal loan guarantees have the largest ROI impact.

These DOE cost estimates are dated and, as noted, more recent CLT plant cost estimates derived from industry data are much higher than the DOE estimates. An informal survey of trends in CTL plant costs indicates that: 1) The most recent cost estimates (where available) are significantly higher than the original estimates; 2) Current CAPEX cost estimates, normalized to a 10K bpd capacity, range between about \$1.2 billion and \$1.5 billion—with the outliers being higher; 3) The projects for which viable recent cost estimates are available have an estimated current average CAPEX cost of \$1.46 billion normalized for a 10K bpd facility; and 4) The projects for which viable original cost estimates are available had an original average CAPEX cost of \$1.0 billion normalized for a 10K bpd facility

These data must be viewed with caution, given the uncertainty of many of the original and the most recent CAPEX cost estimates as well as the fact that none of these plants have yet been built. Further, knowledgeable experts indicate that they feel that even the most recent cost estimates are questionable and likely to increase. Overall, CTL CAPEX cost estimates have increased significantly, perhaps by as much as 50 percent or more over the past several years. However, as noted, the capital costs for all types of energy plant and infrastructure projects have increased significantly in recent years.

Assessing Commercial Viability

To assess the commercial viability of a CTL plant and to conduct an initial business case analysis, the following factors are among those that have to be considered: CAPEX and operating costs, inflation rates, initial plant output, debt equity and interest, depreciation, tax rates, on-stream time, coal requirements and cost the power value of electricity produced, co-products value, the discount rate, the plant life, siting and permitting schedule and costs, and the construction period. Once reasonable values for the above variables are specified, sensitivity analyses need to be conducted to ascertain the significance of the different factors in determining the profitability and commercial viability of the plant. Preliminary estimates indicate that CTL plants are viable if oil is selling in the range of \$60 - \$80 per barrel. However, given the large capital investment required, the length of time needed to bring production on-line, and the many plant-related economic and technical uncertainties, in-depth analysis of each specific plant is required to estimate potential profitability and to facilitate financing.

Barriers and Challenges to CTL Development

The barriers and challenges confronting CTL development can be grouped for discussion into four categories: 1) Economic/financial challenges; 2) Institutional and regulatory challenges; 3) Environmental health and safety challenges; and technical challenges.

Economic and Financial Challenges

The primary financial challenges to CTL development are associated with high and volatile development and capital costs, as well as tangible and intangible risks perceived by potential lenders. Although CTL technology is mature and proven, there has been limited deployment of the technology in the United States. This limited experience, combined with the investment community's unfamiliarity with the technology and the sheer size of the investment required for a full-scale CTL plant, pose economic challenges. In addition, the price of required materials, such as steel and copper, have risen rapidly over the past several years as Asian countries are now importing resources instead of exporting them to the United States and other countries. Even the pre-financing project development phase of a CTL plant presents additional financial risk for developers, and FEED costs can range from \$35 to \$100 million, depending upon the plant's design and product output characteristics.

Many states offer financial incentives, such as loan guarantees, bonding authority, and tax relief, for the development of alternative and clean energy resources, including CTL plants.^{xviii} However, even with such incentives, the cost and associated risks of development of a full-scale plant are significant.

The ability to attract potential equity partners and investors that are willing and able to assume the financial, technological, and intangible risks required to develop CTL projects is impacted by potential lenders' concerns about the technology itself, which has not been demonstrated in the U.S.. Another factor is EPC contractors' reluctance to offer guarantees and associated liquidated damages given the current worldwide development environment, as well as the forward market pricing of fuels (e.g., OPEC's price manipulation potential), and the uncertainty surrounding potential environmental regulations, such as limits on CO₂ emissions. Throughout the course of the development process, potential investors, partners, and others in the corporate community monitor potential project risks—typically financial impacts—that are outside the control of the developer, but have the potential to increase the project's risk profile to unacceptable levels. Examples of such risks include oil and other commodity price fluctuations, as well as uncertainties in government policies and regulations. Specifically, many financiers perceive risk surrounding the general uncertainty of the regulation of CO₂. The long planning timeframes combined with the high financial risk nature of the development process reduces the number of entities willing and able to take such risks to a few companies that recognize the vision and opportunity.

Institutional and Regulatory Challenges

Institutional and regulatory challenges originate primarily from the inexperience in siting and permitting a full-scale CTL facility. Challenges are also created by uncertainty in the regulatory framework and policies yet to be established to regulate CO₂ emissions and site and monitor CO₂ storage locations.

- 1. CTL Plant Siting:** A CTL plant is neither a traditional chemical plant (e.g., a refinery) nor a traditional coal-fired power plant, and thus does not fit criteria for either type of project. It is possible that the coal conversion process may be treated as both a chemical

plant and a power plant, which could significantly complicate the permitting process by requiring the gasifier/power block to obtain one permit and the co-production unit operations to obtain a separate and distinct operating permit. State/federal experience with this type of plant is minimal and thus may slow permitting processes. The fact that CTL plants are new in the United States may also generate increased interest from stakeholders – including environmentalists and community activist groups – regarding plant design and discharges. The existing patch-work of federal, state, and local laws provides fertile grounds for extensive litigation and intergovernmental conflict. Environmentalists and others are likely to vigorously oppose CTL plant development by various litigious means and, even if ultimately unsuccessful, the resulting delay in plant siting and permitting can be a serious impediment.

2. **CTL Infrastructure:** In a mature CTL industry, a robust coal and products transportation infrastructure is necessary to deliver feedstock to the CTL plant and dispatch liquid fuel, CO₂, and other products from the plant to markets or disposal sites. The siting of a CTL plant will have a significant impact on infrastructure requirements. Even a “mine-mouth” plant may require limited-distance coal transportation, and all CTL plants will require a substantial transportation infrastructure for fuels, CO₂, waste products, and construction activity. Further, if a CTL plant is co-fed with biomass, rail transportation will likely be necessary to deliver the quantities of biomass required for co-feed. The delivery of water to the CTL plant, via well, surface, or pipeline must also be considered. Thus, infrastructure planning and development will play an important part in the development of a CTL industry. The most critical of these infrastructure requirements discussed below are coal transport, liquid products transport, electrical transmission, water supply, and byproducts transport, including transport and storage of CO₂.
3. **Coal Transport:** A CTL plant that is sited somewhere other than a coal mine-mouth location will require transport of coal via rail. Even a mine-mouth plant may require limited rail transport to accommodate the coal demand of a commercial-sized CTL plant. For example, a 40,000 bpd CTL plant will require 19,000 tons/day of coal (5.9 million tons/year), equivalent to an average of 1.3 unit coal trains per day.^{xix} The railroads may readily be able to accommodate these additional unit trains within their existing system given that, in Wyoming alone, approximately 80 unit trains per day leave the Powder River Basin coal mines to supply power plants across the United States. A mature CTL industry producing 2 million bpd would require 100 unit trains/day hauling over 300 million tons/year of coal. Such an increase would require a significant investment over time by the railroad industry in both equipment and track.
4. **Liquid Products Transport:** The liquid products from a CTL plant will include diesel and naphtha or gasoline. The most common and cost-effective means of transporting the fuels will be via pipeline from the plant to a refiner/blender or possibly end-user. Diesel, gasoline, and naphtha can be transported via truck, rail, pipeline, or barge.
5. **Electrical Distribution and Transmission:** Electrical distribution and transmission lines are required to provide electricity for plant startup as well as for transporting electricity

generated from the CTL plant. As with any chemical plant or petroleum refinery, a CTL plant will require a 50-75 MW back-feed for a ‘black’ startup of the process equipment, primarily the air separation unit. As for any electricity generation station, the power must be conveyed over adequate capacity transmission lines to deliver the electricity to the grid. Depending on the size and configuration of the CTL plant, and the CTL developer’s ability to enter into an electric off-take agreement with a utility or other electric load, several hundred net MW of electricity could be placed on the electric grid for sale. To accomplish this, a substation may need to be constructed and transmission lines would likely need to be run from the CTL plant to a nearby transmission system capable of accepting the excess load from the CTL plant.

- 6. Plant Byproducts Transport:** A CTL plant will create products, other than liquid transportation fuels, that must be transported from the plant site and disposed of or used to produce other marketable products. This includes slag from the gasifier, spent catalyst, mercury and other trace metal-containing activated carbon, and elemental sulfur -- or sulfuric acid if that is the sulfur-containing product. The mercury containing activated carbon will need to be transported by truck via certified hauler and disposed of in an approved hazardous waste disposal site. The sulfur (or sulfuric acid) and slag could be sold as feedstock to produce secondary products and would be hauled via truck or rail depending upon the quantities produced. The spent catalyst is not considered hazardous waste, but it will need to be trucked offsite and disposed of in a landfill.

Environmental Challenges

CTL raises three principal environmental concerns: 1) CO₂ and climate change mitigation; 2) issues related to the prospective increase in coal production and 3) water resources management—particularly in the western United States where water is typically a constrained resource.

- 1. CO₂ management, regulation, and process considerations:** CO₂ emissions produced by CTL plants will present a challenge to the potential development of the industry. CO₂ injection is currently being used in the United States to help increase oil production via EOR, and there exists a substantial knowledge base regarding how to handle CO₂ and inject it into deep geologic structures for EOR applications. However, much additional research, demonstration, and testing is required to fully understand technology and infrastructure requirements for CO₂ capture, transportation (via pipeline), and deep underground injection—especially in regards to the locations and quantities anticipated from power plants.

The transport of large volumes of CO₂ via pipeline is well established within segments of the oil and gas industry; there are over 1,500 miles of dedicated CO₂ pipelines within North America delivering CO₂ to commercial EOR projects in areas such as the Permian Basin of West Texas and southeastern New Mexico, the Rocky Mountain Region of Utah, Wyoming, and Colorado, Louisiana, and the Weyburn Field in Saskatchewan (see Figure 5.16). However, with the exception of the CO₂ from the Dakota Gasification Plant, all the CO₂ is naturally occurring.

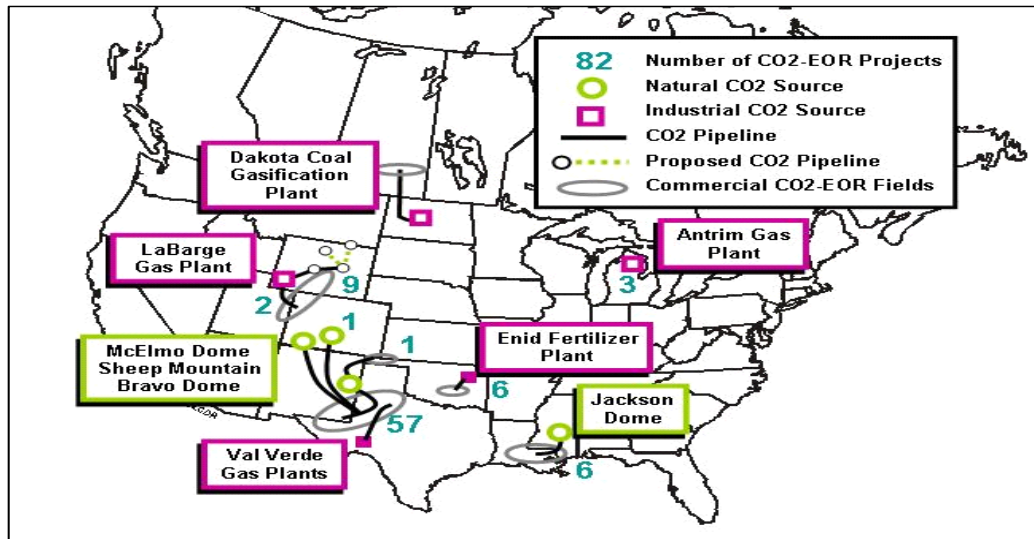

Source: U.S. Department of Energy, Strategic Unconventional Fuels Task Force, 2007

Figure 5. 16. EOR Projects and Carbon Dioxide Sources and Pipelines in the United States

CTL projects are relatively clean with regard to regulated criteria emissions, but uncertainty arises with respect to management of currently unregulated CO₂ emissions. The CO₂ issue will be an important component of CTL development in light of the quantity of CO₂ produced in the gasification/water-gas shift processes.

To assess the global warming implications of coal-to-liquids, the total lifecycle (or “mine-to-wheels”) emissions of these new fuels must be analyzed. Currently available models for calculating lifecycle emissions from CTL plants provide relatively crude estimates of some components of emissions and have yet to be validated.^{xx} Therefore, it is important to improve and validate these models and undertake plant-specific, lifecycle studies for all alternative fuels to more adequately compare impacts relative to petroleum.

When coal is converted to transportation fuels, two streams of CO₂ are produced. One is a result of the production process at the CTL plant and the second is a result of burning that fuel for transportation purposes. When added together, these streams constitute the main greenhouse gas lifecycle emissions of coal-to-liquids. There have been several carbon lifecycle analyses undertaken for CTL. These studies have produced somewhat different estimates, but can be generalized as follows:^{xxi} First, absent the capture and storage of carbon dioxide from the plant, use of liquid fuel derived from coal may roughly double the CO₂ emissions compared to conventional petroleum on a lifecycle basis; second, with capture and storage of most of the carbon dioxide from the plant, GHG emissions will be comparable to emissions from conventional petroleum on a lifecycle basis.

If no provisions are in place to manage carbon dioxide emissions, then the use of CTL fuels to displace petroleum fuels for transportation uses will increase CO₂ emissions. The increase in CO₂ emissions is primarily attributable to the large amount of carbon dioxide emissions that are generated by a CTL plant relative to a conventional oil refinery. However, looking solely at the combustion or end use application of these coal-derived fuels—opposed to their production—some analyses indicate that combustion of these fuels may produce somewhat lower GHG emissions relative to the combustion of a gasoline or diesel motor fuel prepared by refining petroleum.

There are several generic options for managing CO₂ emissions from CTL plants, including carbon capture and sequestration, carbon dioxide capture and use in enhanced oil recovery, enhanced natural gas production, enhanced coal bed methane recovery, and gasification of both coal and biomass followed by FT synthesis of liquid fuels. To assess the economics and feasibility of various CCS options, many factors have to be addressed, including the incremental capital and operating costs involved, sequestration potential, infrastructure requirements, the price at which the CO₂ can be sold, the volumes of CO₂ expected from the CTL plant, monitoring and verification costs, and carbon credits available (if any).

- 2. Issues related to increase in production:** A strategy that can be employed to significantly reduce the lifecycle greenhouse gas emissions associated with CTL plants is to co-fire/co-process biomass with the coal. By capturing and storing the carbon dioxide generated—in part, as a result of the biomass in the production process—net lifecycle greenhouse gas emissions of the liquid fuel are much improved over a liquid transportation fuel derived solely from coal. Non-food crop biomass resources suitable as feedstocks for FT biomass-to-liquid production plants include mixed prairie grasses, switch grass, corn stover and other crop residues, forest residues, and crops that might be grown on dedicated energy plantations. When such biomass resources are used to produce liquids through the FT method, research shows that GHG emissions should be well below those associated with the use of conventional petroleum fuels. Moreover, when a combination of coal and biomass is used, for example, a 50-50 mix, net carbon dioxide emissions will be comparable to or, more likely, lower than wells-to-wheels emissions of conventional petroleum derived motor fuels.

As noted, RAND examined liquid fuel production concepts in which CCS is used in conjunction with the combined gasification of coal and biomass. It estimates that a 50-50 coal-biomass mix combined with CCS should yield zero, and possibly negative, carbon dioxide emissions. In the case of negative emissions, the net result of producing and using the fuel would be the removal of carbon dioxide from the atmosphere.

One perspective on the combined gasification of coal and biomass is that biomass enables FT coal-to-liquids, in that the combined feedstock approach provides an immediate pathway to unconventional liquids with no net increase in GHG emissions, and an ultimate vision, with carbon capture and sequestration, of zero net emissions. Another perspective is that coal enables

FT biomass-to-liquids, in that the combined approach reduces overall production costs by reducing fuel delivery costs, allowing larger plants that take advantage of economies of scale, and smoothing over the inevitable fluctuations in biomass availability associated with annual and multi-year fluctuations in weather patterns, especially rainfall.

- 3. Water consumption and availability:** Water requirements and availability are important environmental issues, especially in large portions of the western United States Surface water supplies are limited and, in recent years, drought in the west and in other regions has made this situation even worse. Economic and population growth throughout the United States will put increasing pressure on scarce hydrological water supplies. Accordingly, the availability of consumable water can be a major consideration in the location, design, efficiency, and overall cost of CTL projects.

The CTL industry believes that it is possible to significantly reduce the demand for water by using designs incorporating a combination of dry-fed gasifier technology, air cooling (also known as dry cooling), and other water enhancement techniques similar to those used in power plant applications. Furthermore, a CTL plant does not require “first use” water. Rather, non-potable water and other, alternative sources of water can be utilized, including gray or secondary use water, such as effluent/process water/ municipal wastewater return flows, and deep or non-potable groundwater supplies.

Studies have been conducted that estimate the volume of water needed to convert coal to liquid transportation fuels. For example, a 1998 Bechtel study found that the ratio of water consumption to product was 5-to-1. Similar results were reported in a 2005 Parsons study that analyzed the water needs for a 50,000 bpd FT facility (4.9 units of water to 1 unit of FT liquid). While neither of these studies considered the use of modern dry-cooling technology currently utilized by power producers in the western United States, a preliminary engineering study conducted by the State of Wyoming, Rentech, and Jacobs Consultancy specifically considered water usage in the context of a water-constrained environment. This study found that through the use of dry-fed gasifier technology, dry cooling, and other water mitigation measures, water use in a proposed Wyoming CTL plant could be decreased to a ratio of less than 1 to 1 (water to product). Further, the study found that employing the technologies to reduce water demand to this level would not be prohibitively expensive.

NETL and RAND have conducted research on water consumption and production in FT plants that use natural gas as a feedstock to produce liquid fuels. Based on this research, it estimated that at least 1.5 barrels of water would be consumed in a CTL plant for each barrel of liquid product produced. To obtain the minimum water usage, researchers found that the plant would have to install dry cooling towers and incorporate extensive measures to minimize water losses in the power generation and oxygen production portions of the plant. The net result of designing such a plant would be an increase in investment costs and a reduction in the operating efficiency of the plant. As a result, such a plant would only be built in areas in which water, including suitable groundwater, was in very limited supply.

In areas in which water is abundant, the studies estimated that as much as 10 barrels of water would be consumed in a CTL plant for each barrel of liquid product produced. Such a plant would likely use less expensive evaporative cooling towers, and the change from dry cooling towers to evaporative cooling accounts for most of the additional water losses. The remaining losses are associated with less recycling of process water. For most CTL plants, the water consumption will fall between 1.5 and 7 barrels of water per barrel of liquid product produced, with the actual amount depending on the cost, availability, and quality of local water supplies. Using MTG to produce transportation fuels along with air cooling generates a significant amount of water which is processed and recirculated. Studies show that a project can consume less than one barrel of water for every barrel of fuel produced.

Technical Challenges

Technical challenges related to the development of a mature U.S. CTL industry are primarily the result of the lack of U.S.-based experience in CTL plant engineering and construction. Key factors include: 1) Limited plant industrial and labor resources; 2) Capital and infrastructure constraints; 3) Labor and personnel constraints.

- 1. Limited plant industrial and labor resources:** CTL projects are large, technically complex facilities that require several years to design and construct. At an average cost of \$100,000 per daily barrel of synthetic fuel, a 20,000 bbl/day plant will exceed \$2 billion in capital investment. This compares with an estimated capital cost of \$15,000 to \$20,000 per daily barrel of oil refined for a state-of-the-art refinery.

The current levels of refinery and chemical plant construction, refinery upgrade projects, power plant construction, and energy development worldwide—including the massive industrial process and energy projects that are taking place in the Middle East, India, and China—are creating significant resource constraints with respect to availability of design and process engineering firms. As a result, the number of qualified engineering and construction firms that can respond to a CTL opportunity is limited.

Engineering and construction contractors are currently charging premium rates, while taking few, if any, risks for project performance. This has moved potential lenders out of their comfort zones, which has further complicated the design and engineering, procurement and construction (EPC) contracting process. In an effort to compete for the limited engineering and construction resources currently available, China and other sponsors of world projects are not requiring liquidated damages and other project performance and financial risk mitigations, which have typically been borne by EPC contractors and are generally required in the United States by project lenders. As a result, the large, world-class contractors qualified to engineer and build CTL projects have their choice of which projects to support.

The worldwide activity in large plant construction projects combined with a historically decreasing skilled labor pool to design, construct, and operate these plants, has placed a severe constraint on the availability of labor (at any cost) to supply the needs of a mature CTL industry. It is estimated that on a national level, 45 percent of the engineering sector's labor will be eligible to retire in the next five years. This results in long lead times for design, engineering, and construction and subsequent increased cost for an already premium-cost plant.

- 2. Capital and Infrastructure Constraints:** In recent years, capital and infrastructure costs for all types of energy projects have increased dramatically, and are expected to continue increasing (see Figure 5.17). By late 2007, costs associated with constructing new oil and gas facilities had increased to a record high. Through November 2007, the HIS/CERA Upstream Capital Costs Index (UCCI), a measure of project cost inflation, rose 11 percent to a new high of 198 points—nearly double the costs observed as recently as 2005. Construction costs began their dramatic rise in 2005 driven by a sudden, sustained increase in the price of steel in 2003 followed by the upward movement in oil prices that began in 2004. As industry activity levels increased in 2005 and 2006, manufacturers and suppliers of oil and gas equipment and services reached maximum capacity and began to increase their prices. The cumulative effect of tight capacity due to high activity levels and high raw material costs was a near doubling in two years (106 points in 2005 to 198 points in 2007) in capital required to build the same volume of facilities.
- 3. Labor and Personnel Constraints:** In April 2006, an analysis of energy industry labor and personnel constraints was conducted for the National Research Council of the National Academy of Sciences. It found that the U.S. oil and gas industry currently employs 1.7 million workers, and generates another 2.3 million jobs indirectly, and that one of the major constraints on increasing O&G production is shortages of workers at all levels. The report concluded, “The key to past performance has not been the expansion of resources in the ground but rather the sustained application of new technologies by skilled professionals. Technology will be even more important to sustaining industry growth in the future. So, too, will be the availability of skilled professionals to apply that technology.” The analysis identified some common themes in the energy industries, including: the average age of employees in the energy industries is very high; degree programs and enrollments are down significantly; a large near term wave of retirements is likely; there is difficulty in recruiting new workers; there is a lack of succession planning; the shortage of workers is restraining industry expansion; there will likely be a very large increase in demand for output and workers in next two decades; many applicants lack the requisite skills and education; and there are not nearly enough workers “in the pipeline.” The study concluded that the U.S. energy workforce infrastructure has seriously degraded over past two decades, and it may take decades to remedy this. However, there may not be decades available to remedy the problem.

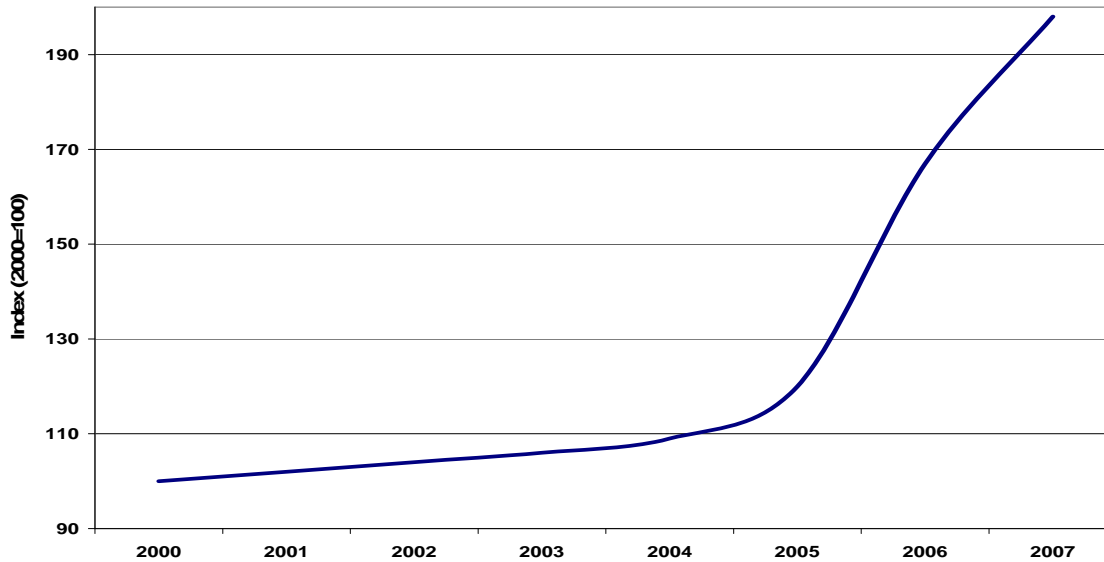

Source: Cambridge Energy Research Associates, 2007.

Figure 5.17. HIS-CERA Upstream Capital Costs Index

These findings are corroborated by other studies. For example, Poten & Partners found that complaints by major engineering, procurement, and construction contractors that their work is being hampered by a shortage of skilled resources are backed up by hard data. A review of company reports indicates that growth within the EPC sector has been largely financial over the last few years. While revenues have risen at annual rates between 12 and 25 percent, employment levels at these firms have remained fairly static. Some of the gains are due to improved productivity, greater technological maturity, and escalating costs. But engineering companies are also squeezing more output from the same resources, and the lack of additional technical expertise is not confined to the larger construction firms. Oil companies have also been actively recruiting experienced technical staff from engineering firms, after years of outsourcing many functions to these same contractors.

Another study found that half of Canada's resource and energy companies report that labor shortages are preventing them from operating at full production, and expect the problem to persist for up to five years. Eighty percent of 55 oil, gas, power, and mining companies surveyed said a lack of skilled workers has reduced their productivity, according to a survey conducted by Deloitte and the Energy Council of Canada. About 55 percent said the shortage had affected customer demand. Almost half the companies said they face "high-level" shortages of hourly workers, which they expect to continue for three to five years. That may cost Alberta's oil sands more than C\$30 billion in development over the next decade, according to the National Energy Board.

Another study reports that the mainstay of the oil and gas industry workforce will retire in the coming ten years. While there is a fair amount of effort underway in the O&G industry, the labor factor is being largely ignored in the energy scenarios of the International Energy Agency and Energy Information Administration.

The retirement of the workforce in the energy industry is normally referred to as “the big crew change.” Employees in this sector normally retire at the age of 55. Since the average age of an employee working at a major oil company or service company is 46 to 49 years old, there will be a huge change in personnel in the coming decade, hence the “big crew change.” This age distribution is a result of the oil crises in 1970s and 1980s. Rising oil prices led to a significant increase in the inflow of petroleum geology students, which waned as prices decreased.

The problem has been aggravated due to the loss of in-house training programs in many large energy companies and the loss of research centers in many major oil companies. This was a response to the lower oil prices which caused overall contraction in the industry after the oil crises. The decline in oil prices in 1998/1999, which bottomed at \$12/bbl, also prompted many companies to reduce or abandon drilling, which led to the early retirement of thousands of workers at the end of the 20th century.

At a time when incrementally more workers are needed to supply an increasing amount of energy to the world economy, there are not enough new students in the pipeline to replace the senior experts. The problem is made more acute because drilling is taking place in far more complex environments than before—the “easy oil is gone” as Shell and Chevron now commonly state in their PR campaigns. Overseeing project development in today’s industry requires around 10 years of training in the various disciplines. However, there are currently only about 1,700 students studying petroleum engineering in 17 U.S. universities, compared to over 11,000 in 34 universities in 1993.

Surveys of a cross section of U.S. energy companies suggest that the consequences of these trends are both severe and imminent. They document that the combined effects of demographics and increasing technical skill requirements are likely to pose major challenges to both recruiting and managing the workforce over the next five years. If all of the anticipated needs over that period could be satisfied, about a third of the key technical positions would turn over in just five years. But the feasibility of this replacement is problematic, as revealed by a broad concern over shortages in all of the key technical skill.

REFERENCES

- Ait-Laoussine, N. "The Role of National Oil Companies in International Energy Markets." The Baker Institute Energy Forum Workshop on the Role of the NOCs, May 5, 2005.
- Aleklett, K. and C.J. Campbell. *"The Peak and Decline of World Oil and Gas Production."* Uppsala University, Sweden, ASPO web site.
- Bajura, Richard A. and Edwar M. Eyring. "Coal and Liquid Fuels." presented at the GCEP Advanced Coal Workshop, Provo, Utah, March 2003.
- Barna, Theodore K., J. Edward Sheridan, and William E Harrison III. "OSD Clean Fuel Initiative." Office of the Secretary of Defense, January 2006.
- Bartis, James. "Policy Issues for Coal-to-Liquid Development." Testimony before the Senate Energy and Natural Resources Committee, May 24, 2007.
- Bartis, James. "Policy Issues for Coal-to-Liquid Development." Testimony before the Senate Energy and Natural Resources Committee, Addendum, June 2007.
- Bezdek, Roger H., Robert M. Wendling, and Robert L. Hirsch. *Economic Impacts of U.S. Liquid Fuel Mitigation Options.* Report prepared for the U.S. Department of Energy, National Energy Technology Laboratory, July 2006.
- Bezdek, Roger H., Robert M. Wendling, and Robert L. Hirsch. "Peaking Oil Production: Sooner Rather Than Later?." *Issues in Science and Technology*, Spring 2005, pp. 25-30.
- "The Big Crew Change: Turnover in The Oil Workforce," *The Oil Drum*, March 15, 2007.
- Boardman, R. D. "Plant Modeling and Emissions Comparative Analysis Approach – Coal/Biomass Gasification with Fischer-Tropsch Diesel Production." Beard Energy, May 18, 2007.
- Bowen, Irwin M. W., B. H. Preckel, P V, Yu, J. Rupp, F.H. Hieb, and M. Mastalerz. *A Feasibility Study for the Construction of a Fischer-Tropsch Liquid Fuels Production Plant With Power Coproduction at NSA Crane*, May 31, 2007.
- Brandt A R, and J.A. Farrel. "Scraping the Bottom of the Barrel: Greenhouse Gas Emission Consequences of a Transition to Low-Quality and Synthetic Petroleum Resources." *Climatic Change*, Vol. 84, October 2007, pp. 241-263.

Cambridge Energy Research Associates. "Oil & Gas Construction Costs Reach New High; IHS/CERA Upstream Capital Costs Index Up 11 percent in 6 Months to 198 Points," November 7, 2007.

"Coal to Liquids and Gas." Working Document of the National Petroleum Council, Global Oil and Gas Study Made Available July 18, 2007.

"Contracting Industry Hit By Skilled Labor Shortage." *Poten Highlights*, Poten & Partners, January 2007.

Couch, G. *Coal to Liquids*. International Energy Agency, Paris, December 2007.

Davis, B. H. "Fischer-Tropsch Synthesis: Overview of Reactor Development and Future Potentialities." *Topics in Catalysis*, March 2005, pp. 143-168.

Dooley, J, et. al. *Carbon Dioxide Capture and Geologic Storage: A Technology Report From the Second Phase of the Global Energy Technology Strategy Program*. Battelle, April 2006.

Energy Business Reports. *Commercialization of Coal to Liquids Technology*. 2007.

Energy Watch Group. *Coal: Resources and Future Production*. EWG Paper 1/07, July 2007.

"Flying on Coal: JetBlue Chief has a Better Way to Cut Fuel Costs." *Long Beach Press-Telegram*, 11-17-06.

Freerks, R. L. H. Wright, and J. Marano. "Life-cycle Assessment of CTL Plants in Comparison to Conventional and Heavy Oil Derived Fuels." In: *Proceedings of the 24th Annual International Pittsburgh Coal Conference*, Johannesburg, South Africa, 2007.

Hirsch, Robert L., Roger H. Bezdek, and Robert M. Wendling. *Peaking of World Oil Production: Impacts, Mitigation, and Risk Management*. Report prepared for the U.S. Department of Energy, National Energy Technology Laboratory. "Peaking of World Oil Production and its Mitigation." *Journal of the American Institute of Chemical Engineers*, Vol. 52, No 1 (January 2006), pp. 2-8.

Höök, Mikael, Werner Zittelb, Jörg Schindlerb, and Kjell Aleklett. "A Resource-Driven Forecast for Future Global Coal Production." Paper submitted to *Energy Policy*, October 2007.

Hornick, M. "Tampa Electric's IGCC Success." *EnergyBiz Magazine*, July/August 2007.

International Energy Agency. *World Energy Outlook, 2007*.

International Energy Agency, Coal Industry Advisory Board. *Workshop on Coal-to-Liquids: An Alternative Oil Supply?* Paris, November 2006.

James, Steve. "Liquid Coal: A Cheaper, Cleaner 21st Century Fuel?" Reuters, 12-17-06.

Koleda, M. and D. Gray. *Building a U.S. Coal-to-Liquids (CTL) Industry: Requirements and Implications*. Noblis, October 2007.

Management Information Services, Inc. "Energy Workforce Needs for the 21st Century." Prepared for the National Research Council of the National Academies of Science, April 2006.

Marano, John J. and Jared P. Ciferno. *Life-Cycle Greenhouse-Gas Emissions Inventory for Fischer-Tropsch Fuels*. Report prepared for the U.S. Department of Energy, National Energy Technology Laboratory, 2001.

Massachusetts Institute of Technology, *The Future of Coal*, Cambridge, Massachusetts, 2007.

Marrow, E. "The Cost of Project Risks: Contracting for Large International Projects in the New Era." Independent Project Analysis, Inc., 2006.

Miller, L. "Coal Conversion – Pathway to Alternate Fuels." 2007 EIA Energy Outlook Modeling and Data Conference, March 28, 2007.

Naqvi, S. *Dimethyl Ether as Alternate Fuel*. Report No 245, SRI Consulting, Menlo Park, California, June 2002.

National Coal Council. *Coal: America's Energy Future*. Washington, D.C., March 2006.

National Energy Technology Laboratory. *Baseline Technical and Economic Assessment of a Commercial Scale Fischer-Tropsch Liquids Facility*, April 2007.

National Energy Technology Laboratory. *Increasing Security and Reducing Emissions of the U.S. Transportation Sector: A Transformational Role for Biomass*, August 24, 2007.

Olsen, Scott, and Michael Reed. "Impacts of Future US GHG Regulatory Policies on Large-Scale Coal to Liquids Plants." In: *Proceedings of the Sixth Annual Conference on Carbon Capture and Sequestration*. DOE/NETL, Pittsburgh, May 2007.

Putrich, Gayle S. "DOD Pushes to Make Synthetic Fuel a Reality." *Air Force News*. July 23,

2007.

Reed, M.E. *Increasing Security and Reducing Carbon Emissions of the U.S. Transportation*

Sector: A Transformational Role for Coal with Biomass. DOE/NETL-2007/1298, August 24, 2007.

Smith, Fred. “Remarks” at the American Energy Security Summit: “Energy Independence Through Domestic Alternative Liquid Fuels.” Alexandria, Virginia, April 2007. Southern States Energy Board, *American Energy Security: Building a Bridge to Energy*

Independence and to a Sustainable Energy Future. Norcross, Georgia, July 2006.

Tam, S., T. Lee, and J. Liu. “Coal-to-Liquid Polygeneration Options.” Paper presented at the

Electric Power Generation Conference Workshop, Chicago, April 30, Headwaters Energy Services, 2007.

Thielemann, Thomas, Sandro Schmidt, and J. Peter Gerling. “Lignite and Hard Coal: Energy

Suppliers for World Needs Until the Year 2100—an Outlook.” *International Journal of Coal Geology.* Volume 72, (2007), pp. 1-14.

“U.S. Airlines Support Development of Alternative Fuels.” Air Transport Association of

America, December 2006.

U.S. Department of Energy. *Beluga Coal Gasification Feasibility Study*, 2006.

U.S. Energy Information Administration. “Recoverable Coal Reserves at Producing Mines,

Estimated Recoverable Reserves, and Demonstrated Reserve Base by Mining Method,” 2004

U.S. Energy Information Administration. *Energy Market and Economic Impacts of a Proposal to*

Reduce Greenhouse Gas Intensity with a Cap and Trade System, January 2007, SR/OIAF/2007-01.

U.S. Energy Information Administration. *Annual Energy Outlook 2008*, December 2007.

“U.S. Military to ‘Jump Start’ Synthetic Jet Fuel Market With Tender.” *Platts*, 11-16-06.

Van Bibber, L. et al. *Baseline Technical and Economic Assessment of a Commercial Scale*

Fischer-Tropsch Liquids Facility. U.S. Department of Energy, 2007.

Western Governors’ Association. *Transportation Fuels for the Future: Coal to Liquids*, January

8, 2008.

Williams, R. H, and E.O. Larson. “A Comparison of Direct and Indirect Liquefaction

Technologies for Making Liquid Fuels From Coal.” *Energy for Sustainable Development*. Vol. VII, December 2003, pp. 103-129.

Work Group on Coal to Liquids. “Report to the Task Force on Strategic Unconventional Fuels.”

U.S. Department of Energy Unconventional Fuels Task Force, August 2006.

Chapter Six

Underground Coal Gasification

NOTE: This work is a summarization of a study analyzing the current state of the art of Underground Coal Gasification (UCG) conducted at the request of the Department of Energy, Office of Fossil Energy and first reported in Burton, E, Friedmann, SJ, Upadhye, R, in press, Best Practices in Underground Coal Gasification, Lawrence Livermore National Laboratory Report # UCRL-TR-225331-DRAFT, 119 pp.

Given the dramatic increase in interest worldwide in underground coal gasification (UCG), particularly in developing countries, and the increased emphasis on carbon management through capture and sequestration, it is worth considering how the United States will consider this technology option. There are multiple possible actions the United States could take, either solely from government action or in collaboration with industry.

FINDINGS

The NCC finds the following:

6. Underground coal gasification (UCG) converts coal in-situ into a gaseous product, commonly known as substitute gas or SNG through the same chemical reactions that occur in surface gasifiers.
7. Gasification converts hydrocarbons into a SNG at elevated pressures and temperatures, and can be used to create many products including electric power, chemical feedstock, liquid fuels, hydrogen and substitute natural gas.
8. Gasification provides numerous opportunities for pollution control, especially with respect to emissions of sulfur, nitrous oxides, and mercury.
9. UCG could significantly increase the coal resource available for utilization by gasifying otherwise unmineable deep or thin coals under many different geological settings. A 300-400 percent increase in recoverable coal reserves in the United States is possible.
10. For developing countries undergoing rapid economic expansion, including India and China, UCG also may be a particularly compelling technology.

RECOMMENDATIONS

The NCC recommends the following:

8. Renewed research program – The US disbanded its research program in 1989. Since then, no government agency has sponsored scientific research into UCG processes or products. A number of outstanding technical issues, including costs and economics, process engineering, subsurface process monitoring and control, risks and hazards, and synergies with carbon management remain unexplored. Improved simulations are also needed for gasification, formation of the cavity, the flow and transport of contaminants and subsidence in order to better define the boundary conditions for practice and to decrease the learning curve. A substantial research program is recommended that includes participation of research institutions, universities, and companies.
9. Given the relatively minimal experience in the United States with UCG, a serious, detailed engineering analysis of each step in the entire process should be undertaken along with a thorough economic analysis that includes but is not limited to estimates of the cost at various stages of development and operation and a comparison of UCG with other technologies used to generate electricity.
10. Since UCG has the ability to use what has historically been considered to be unmineable coal, thereby increasing the overall potential coal supply in the United States, further study should be undertaken to quantify the amount of unmineable coal and its ability to contribute to the energy needs of this country. A partnership between the USDOE and US Department of the Interior through the assistance of the US Geological Survey would be useful.
11. Engage with field demos – The two existing and rapidly emerging field programs in the US, China, and North America provide near-term opportunities for investigating key technical and non technical concerns. These are platforms to test subsurface monitoring equipment, validate simulators and models, and understand potential environmental concerns. Some projects might be pursued through the Asian Pacific Partnership given the needs in developing countries around pollution abatement and clean coal technology development. Others could be pursued through public-private partnerships. The DOE should assess these pilots and investigate their current status and goals in considering which ones provide the best opportunities to meet key goals. Additional funds beyond a core R&D program should be brought forward for field testing, monitoring, and validation.
12. Develop standards – At present, there are no broadly accepted standards for siting and operation of UCG projects and facilities. To help commercialization in North America, we recommend a 3-5 year research program aimed at providing key industries, regulators,

and decision makers with the technical basis needed to screen out problem sites and encourage sound investment.

13. Understanding UCG and CCS – In-situ gasification has the potential to dramatically reduce the costs of SNG production and thereby CCS. However, these two enterprises are fundamentally distinct and have their own technical, commercial, and environmental needs. We recommend a formal program to investigate how UCG might enable or hinder CCS development and deployment and to identify potential synergies that will enhance economics and site performance.
14. Develop materials for outreach and education on UCG – Few decision makers in the US are familiar with UCG as an energy technology option. The DOE should engage its own expertise and knowledge to develop briefing materials and public outreach documents that could be used to engage stakeholders.

This list is not meant to be exclusive, but rather to focus on areas where short-term needs have been identified. Given the apparent promise of UCG, we recommend a proactive stance in considering how to rapidly support this emerging industry in the US.

INTRODUCTION

UCG converts coal in-situ into a gaseous product, commonly known as substitute gas or SNG through the same chemical reactions that occur in surface gasifiers. Gasification converts hydrocarbons into a SNG at elevated pressures and temperatures and can be used to create many products (electric power, chemical feedstock, liquid fuels, hydrogen, synthetic gas). Gasification provides numerous opportunities for pollution control, especially with respect to emissions of sulfur, nitrous oxides, and mercury. UCG could increase the coal resource available for utilization enormously by gasifying otherwise unmineable deep or thin coals under many different geological settings. A 300-400 percent increase in recoverable coal reserves in the United States is possible. For developing countries undergoing rapid economic expansion, including India and China, UCG also may be a particularly compelling technology.

UCG has been tested in many different experimental tests in many countries. The United States carried out over 30 pilots between 1975 and 1996, testing bituminous, sub-bituminous, and lignite coals. Before that, the Former Soviet Union executed over 50 years of research on UCG, field tests and several commercial projects, including an electric power plant in Angren, Uzbekistan that is still in operation today after 47 years. Since 1991, China has executed at

least 16 tests, and has several commercial UCG projects for chemical and fertilizer feedstocks. In 2000, Australia began a large pilot (Chinchilla), which produced SNG for three years before a controlled shut-down and controlled restart. At present, multiple commercial projects are in various stages of development in the U.S., Canada, South Africa, India, Australia, New Zealand, and China to produce power, liquid fuels, and SNG.

Several processes exist to initiate and control UCG reactions, including the Controlled Retraction Injection Point (CRIP) process and Ergo Exergy's proprietary UCG process. These ignition processes create a SNG stream which is compositionally similar to surface-produced SNG. It can have higher CO₂ and hydrogen products due to a number of factors, including a higher than optimal rate of water flux into the UCG reactor and ash catalysis of water-gas shift. Because of the nature of in-situ conversion, UCG SNG is lower in sulfur, tar, particulates and mercury than conventional SNG and has very low ash content. Other components are similar and can be managed through conventional gas processing and clean up.

The economics of UCG appear extremely promising. The capital expenses of UCG plants appear to be substantially less than the equivalent plant fed by surface gasifiers because purchase of a gasifier is not required. Similarly, operating expenses are likely to be much lower because of the lack of coal mining, coal transportation, and significantly reduced ash management facilities. Even for configurations requiring a substantial environmental monitoring program and additional swing facilities, UCG plants retain many economic advantages. This is reflected in the commencement of activities on over 17 commercial projects worldwide, including active pilots in South Africa and China that are undergoing commercialization and scale-up.

UCG has the potential to create two environmental hazards if operations are not optimally managed: ground-water contamination and surface subsidence. Both of these hazards appear avoidable through careful site selection and adoption of best management practices for operations. At Hoe Creek, WY, U.S., the site of several UCG pilot tests, improper site selection and over-pressurization of the reactor drove a plume containing benzene, volatile organic carbons, and other contaminants into local fresh-water aquifers. In contrast, the recent pilot at Chinchilla, Australia, demonstrates that it is possible to operate UCG without creating either hazard. An explicit risk management framework (e.g., risk-based decision making) can be used to identify and proactively address the component risks involved in UCG siting and operations. Environmental risk assessment for UCG has unique aspects, requiring consideration of a complex array of changing conditions, including high cavity temperatures, steep thermal

gradients, and stress fields obtained during and after the burn process. In the context of the site stratigraphy, structure and hydrogeology, risk models must evaluate the permeability changes from cavity development and collapse as well as the effects of changes in buoyancy, thermal and mechanical forces on the transport of organic and inorganic contaminants. Operational variables (e.g., temperature, feed gas composition) also impact the amount and nature of contaminants produced and groundwater flow directions. Furthermore, subsequent use of the cavity for CO₂ sequestration will impact the mobility of byproducts and will alter risk.

The challenge of managing CO₂ emissions creates a strong drive towards pairing UCG with carbon capture and sequestration (CCS). The composition and outlet pressures of UCG streams at the surface are comparable to those from surface gasifiers; as such, the costs and methodologies for pre-combustion separation are directly comparable (e.g., Selexol at \$25/ton CO₂). Conventional post-combustion and oxy-firing options may also be applied to UCG-driven surface applications. In addition, the close spatial coincidence of conventional geological carbon storage (GCS) options with UCG opportunities suggests that operators could co-locate UCG and GCS projects with a high likelihood of effective CO₂ storage. There is also the possibility of storing some fraction of concentrated CO₂ streams in the subsurface reactor. While this appears to have many attractive features, there remains substantial scientific uncertainty in the environmental risks and fate of CO₂ stored this way.

While UCG appears to be commercially ready in many contexts, there remain several key scientific and technical gaps. These gaps could be addressed in a short period of time with an accelerated research program. This program could lever substantially off of existing knowledge, planned commercial tests, and advances in engineering and earth science simulations. The United States should undertake a plan to evaluate advanced simulation opportunities, critical laboratory components, and current and potential sites for field work, especially in monitoring and process control. This research would help to support a framework proposed herein for best practices, and validate aspects of the current understanding that have not been thoroughly studied and rendered.

OVERVIEW

The energy economic and environmental demands of the 21st century appear to support a renewed and expended role for commercial UCG development. Definition of the future United States role in R&D for UCG must be based on an integration of the worldwide knowledge base and the international collective experience in UCG. The goals of this chapter is to create a foundation for that role by summarizing current knowledge of UCG,

identifying where the current knowledge base is sufficient to formulate best practices and where additional R&D efforts are needed to make UCG a successful commercial technology.

Underground Coal Gasification Process Description

Gasification is a chemical process for converting a solid or liquid fuel into a combustible gas that subsequently can be used to produce heat, generate power or as a feedstock for chemical products such as hydrogen, methanol or SNG. Hundreds of surface gasification plants have been constructed. More than 160 coal gasification plants worldwide are in operation, producing the equivalent of 50,000 MW (thermal) of SNG (Simbeck, 2002).

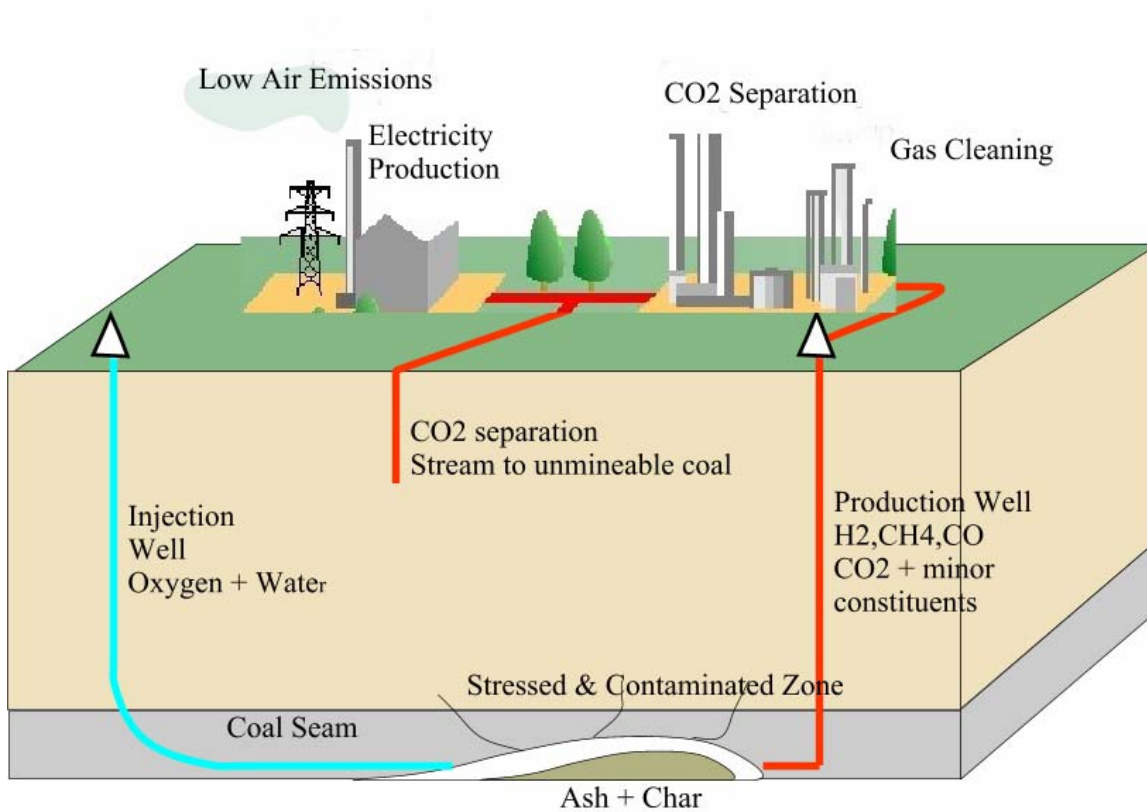

Figure 6.1 : Schematic of components of the UCG process collocated with Electricity generation (UCG Engineering, Ltd., 2006)

Underground coal gasification (UCG), wherein coal is converted to gas in-situ, moves the process of coal gasification underground. Gas is produced and extracted through wells

drilled down into the coal seam, to inject air or oxygen to combust the coal in-situ, and to produce the coal gas to surface for further processing, transport, or utilization (e.g., Figure 6.1. The process relies on the natural permeability of the coal seam to transmit gases to and from the combustion zone, or on enhanced permeability created through reversed combustion, an in-seam channel, or hydro-fracturing (Gregg, and Edgard, 1978; Stephens et al., 1985a; Walker et al., 2001; Creedy & Garner, 2004).

Why Consider Underground Coal Gasification?

The United States is increasingly looking to its coal reserves as a solution to its dependence on imports to fuel its economy. At present rates of consumption of about 1.1 billion tons annually, coal reserves can provide a secure domestic energy supply for nearly the next 300 years. Most coal in the United States is consumed for electricity production. While petroleum imports may be vulnerable to geopolitical uncertainties, domestic coal extraction and usage are limited primarily by environmental concerns. Utilizing coal in place of oil, therefore, poses numerous challenges, including reducing the impact of coal mining and combustion on the environment and human health, and the need to improve technologies to cleanly convert coal to liquid fuels or gas.

UCG has numerous advantages:

- Conventional coal mining is eliminated with UCG, reducing operating costs, surface damage and eliminating mine safety issues such as mine collapse and asphyxiation;
- Coals that are unmineable (too deep, low grade, thin seams) are exploitable by UCG, thereby greatly increasing domestic resource availability;
- No surface gasification systems are needed, hence, capital costs are substantially reduced;
- No coal is transported at the surface, reducing cost, emissions, and local footprint associated with coal shipping and stockpiling;
- Most of the ash in the coal stays underground, thereby avoiding the need for excessive gas clean-up, and the environmental issues associated with fly ash waste stored at the surface;
- There is no production of some criteria pollutants (e.g., SO_x, NO_x) and many other pollutants (mercury, particulates, sulfur species) are greatly reduced in volume and easier to handle;
- UCG eliminates much of the energy waste associated with moving waste as well as usable product from the ground to the surface;
- UCG, compared to conventional mining combined with surface combustion, produces less greenhouse gas and has advantages for geologic carbon storage. The well infrastructure for UCG can be used subsequently for geologic CO₂ sequestration operations. It may be possible to store CO₂ in the reactor zone underground as well in adjacent strata.

Domestic coal also is the obvious source for hydrogen production, especially in light of escalating natural gas prices. The proposition of a hydrogen economy relies on affordable

hydrogen with significantly reduced or near-zero emissions. Although nuclear or renewable energy sources have been proposed to supply the required hydrogen, renewables are still too intermittent and costly and nuclear has yet to satisfactorily solve its waste disposal and proliferation issues. Until these issues are solved, the near to mid-term source for hydrogen is likely to be fossil fuels. Coal gasification, including UCG, provides an attractive pathway to low-cost hydrogen production from coal.

Timeliness of Underground Coal Gasification R&D Investment

A recent resurgence of interest in UCG has been driven in large part by the economic pressures of fuel prices. The current price of light sweet crude oil commodities exceeded \$100/bbl. In this market, many alternative fuels look attractive. As such, the possibility that UCG can deliver SNG at competitive costs has increased interest.

Concerns over the security of fuel supplies also have increased in recent years. The growing instability of the international energy situation is driving stakeholders in countries with major coal deposits and current or future energy deficits, to renew focus on all technologies with potential to increase use of domestic coal resources. These countries include the U.S., some countries of the former Soviet Union, China and India. For example, utilizing UCG to access deep unmineable coal increases estimates of usable United States coal resources by three or more times their current levels (Stephens, et al., 1984).

Gasification technologies for coal resources are receiving great attention because of growing concerns over the global impact of emissions of greenhouse gases and other air emissions in rapidly growing economies such as those of China and India. Given that UCG offers the potential to gasify coal economically and to produce raw materials for economic expansion, government agencies in these and other developing countries with coal deposits, the coal-mining and power industries, as well as integrated energy companies, are increasingly demonstrating interest in UCG.

Potential Limitations and Concerns for UCG

The road to widespread commercialization still holds a number of challenges that will require research and development investment to overcome. Even though UCG has a number of advantages, the technology is not perfect, and has several limitations:

- UCG can have significant environmental consequences: aquifer contamination, and ground subsidence. While a framework can be constructed from current knowledge that can eliminate or reduce these environmental risks, as is discussed at length later in this report, it is important to proactively address this constraint on siting and operation of any future UCG projects;
- While UCG may be technically feasible for many coal resources, the number of deposits that are suitable may be much more limited because some may have geologic and hydrologic features that increase environmental risks to unacceptable levels;
- UCG operations cannot be controlled to the same extent as surface gasifiers. Many important process variables, such as the rate of water influx, the distribution of reactants in the gasification zone, and the growth rate of the cavity, can only be estimated from measurements of temperatures and product gas quality and quantity;
- The economics of UCG has major uncertainties that are likely to persist until such times as a reasonable number of UCG-based power plants are built and operated;
- UCG is inherently an unsteady-state process, and both the flow rate and the heating value of the product gas will vary over time. Any operating plant must take this factor into consideration.

While the DOE was an early pioneer of UCG, interest in further pursuing the technology was curtailed by environmental problems and poor process control of some early U.S. UCG pilot studies. In addition, the perceived need at that time was for pipeline-quality gas (>1000 BTU/cft), whereas the SNG from UCG yielded only 150 BTU/cft. These issues, taken together, were deemed significant enough at the time to discontinue U.S. efforts in UCG research and development. However, overseas, the development of UCG continued during the U.S. hiatus. The fact that the numerous past UCG projects, and the recent Australian pilot, operated without resulting in environmental problems also is receiving renewed recognition.

Potential Use in Developing Countries

As noted above, some developing nations have enormous coal resources that could potentially benefit from UCG commercialization. In particular, India and China have large reserves paired with rapid economic growth that has created unparalleled demands for energy including electricity, liquid fuels, and chemical feedstocks. Simultaneously, these countries are coming to terms with rapid growth in pollution and global concerns with their emissions. UCG provides unique opportunities to serve these rapidly evolving needs for both countries.

INDIA

The Indian economy is growing steadily, limited only by the availability of energy and current infrastructure. More than half of the power consumed in India is from coal. India has huge reserves of coal (bituminous and sub-bituminous). However, most of this coal is low grade, with as much as 35-50 percent ash content. The high ash content of the Indian coals places a limit on the economic transportation distance for these coals. If coal cleaning technologies are made available to India, the efficiency of their coal utilization will improve significantly.

Most of the coal in India is mined by surface mining. Very few coal mines in India are underground. This places a restriction of the de facto availability of the coal, despite the large coal reserves on paper. In addition, India has large deposits of lignite, which is difficult to mine economically, because of its low energy content. In both these cases, underground coal gasification (UCG) presents an attractive alternative.

UCG is well suited to India's current and emerging energy demands. The SNG produced by UCG can be used to generate electricity through combined cycle. It can also be shifted chemically to produce SNG (e.g., Great Plains Gasification Plant in North Dakota). It may also serve as feedstock for methanol, gasoline, or diesel fuel production and even as hydrogen supply. Currently, this technology could be deployed in both eastern and western India in highly populated areas, thus reducing overall energy demand. Most importantly, the reduced capital cost and lack of facilities provide a platform for rapid acceleration of coal based electric power and other high-value products.

To expedite commercial development, the Indian government has amended existing statutes to separate surface and subsurface estates, explicitly approving UCG for coals >300m depth. In response, four companies (Reliance Industries Ltd., Gas India Authority Ltd., Oil and Natural Gas Company, and Tata) have announced projects, placed bids on blocks, and are currently drilling wells and collecting field data for commercial project development

CHINA

The Chinese economy supports the most rapid growth rates of any large country, with average growth rates greater than 8 percent for each year since 1978. They too are limited only by the availability of energy and current infrastructure. More than 65 percent of the power consumed in China is from coal and 70 percent of their electric power. Coal is used as a feedstock for chemical, fuel, and fertilizer plants, and China has over 50 large coal gasification facilities nationwide. It uses over 1.9 billion tons of coal each year, and emits over 3.5 billion tons of CO₂, 75 percent from stationary point sources, mostly coal (World Energy Council, 2004).

China has huge reserves of coal of every rank, estimated at 114 trillion tons (World Energy Council, 2004). This coal varies in grade, including high-low sulfur and high-low ash coal. Coal basins are spread over all of China, but are mostly mined from basins in the east close to population centers. China has the highest incidence of mining accidents. China reports 80 percent of the world's coal mining fatalities associated with only 35 percent of coal utilization. There are many reasons for this, including the large number of small mining operations active throughout the country. In a recent attempt to improve mine safety, many of these mines have been officially closed, leaving thousands of abandoned small underground mines throughout China.

A number of environmental problems stem from China's coal use. The high sulfur content of many coals has resulted in substantial emissions of sulfur aerosols. Similarly, particulate and ozone levels have climbed steeply. Mercury emissions have substantially increased. Although the government has announced clear policies to reduce pollution for the 2008 Summer Olympic Games, it is unclear what effect these policies will have.

Against this backdrop, it is perhaps not surprising that China has emerged as a UCG technology development leader. China has executed at least 16 pilots since 1991, and has invested in extensive research programs at China University of Mining Technology in Beijing. Currently, UCG provides SNG as feedstock to commercial fertilizer and chemical plants. Interestingly, China has explored a technology where abandoned mines are used as gasifiers, utilizing the small closed mines throughout the country. Chinese companies and government entities are accelerating the deployment of commercial UCG. In particular, the XinAo Group (one of China's largest private companies and largest natural gas distributor) initiated a pilot project in Oct. 2007. The results have been sufficiently positive to immediately commercialize a 20,000 ton/y methanol plant by summer 2008, and has prompted an expansion project for a 300,000 ton/y methanol plant by end of 2009.

AUSTRALIA

CSIRO is undertaking feasibility studies of UCG, and is currently evaluating cavity models in association with the University of Sydney, CSIRO have also been examining the process and power implications of UCG.

The Chinchilla Project

The Chinchilla project (Blinderman and Jones, 2002), in Chinchilla (350 km west of Brisbane), Queensland, Australia, was run from 1997 through 2003, and is the largest UCG project to date in the West. Ergo Exergy Technologies Inc., Canada (Ergo Exergy), provided UCG technology for the project under an agreement with the developing company Linc Energy, Ltd., Australia. Ergo Exergy also designed and operated the UCG plant at Chinchilla.

The long-term goals of the Chinchilla project were power production and liquid fuels production using gas-to-liquid technology, such as Fischer-Tropsch synthesis.

The process plant is used to condition the gas to satisfy strict requirements of the gas turbine. Raw gas produced at the wellhead is cooled down to separate the liquids that are further processed and prepared either for sale or disposal. The gas then is cleaned up in sintered metal candle filters. Since candle filters require dry gas for normal functioning, the gas is reheated to

the temperatures above dew point before entering the filters. A pilot cleanup plant simulating conditions of the full-scale process was tested on site.

A gas compressor is required to bring the pressure of the gas to the level acceptable for the gas turbine. Water separated from the gas flow is used for cooling the raw gas in a heat exchanger and air in the air compressor intercoolers. It will also comprise a part of makeup water needed to operate the steam cycle once a steam turbine is installed.

As pointed out by Blinderman (2003b), the need for the gas compressor is dictated only by the specific conditions of Chinchilla site, namely the thickness and permeability of the overburden. A deeper coal seam or less permeable rock in the overburden may allow gasification under much higher pressure, so that the gas can be supplied directly into the gas turbine avoiding the need in additional compression. Figure 3-6 depicts an example of a 70 MW IGCC plant. The Chinchilla project targeted this size of plant in an attempt to minimize the capital investment required and to provide sufficient output to produce attractive commercial returns. The ultimate goal of IGCC development at Chinchilla is the scaling up of the initial plant to the size optimal for commercial performance, possibly 400 MW.

The site selection for the project began in November 1997. By December 1999, the construction was completed, and gas production began on December 26, 1999. The tests and controlled shutdown were completed in April 2003.

The current status of the project is that it is being maintained in preparation for a gas-turbine and gas-cleanup plant, but Linc Energy, Ltd. recently announced plans for a large coal-to-liquids plant at the site, which is in development today.

JAPAN

Japan, which has substantial coal interests outside its borders, as well as continental shelf resources, has included UCG in its future research plans for coal exploitation, and has been

maintaining a low level program for many years. Economic and technical studies have been produced, and there are reports that a Japanese-sponsored trial, possibly overseas, will be undertaken in the near term.

The University of Tokyo has undertaken technical and economic studies of UCG, and maintains a watching brief on behalf of NEDO. Japanese coal companies are interested in the technology as possible export opportunity.

FORMER SOVIET UNION (FSU)

The Former Soviet Union (FSU) was the first nation to initiate a national program of UCG research and development. By 1928, a national research program had been organized, and underground experiments had begun by 1933 at Krutova, Tula, Shakhty, Lenisk-Kuznets, Gorlovka and Lisichansk. In parallel with the experimental program, a theoretical program and laboratory studies were undertaken.

Commercial-scale production of gas was achieved at numerous locations and for long periods of time, most notably at Angren, Shatskaya, Kamen, Yuzhno-Abinsk, and Podmoskovia. UCG activity peaked in the 1960s. The Angren mine still has UCG technology in place to produce 18 billion cubic feet of gas for the Angren power station (U.S. Energy Information Administration, 1977). By 1996, UCG plants in the Soviet Union had extracted over 17 million metric tones of coal (Blindermann, 2005).

UCG production appears to have peaked in the FSU in the mid 1960s. This includes the site in Angren (outside of Tashkent, Uzbekistan). UCG at Angren began in 1959, and has continued more or less without interruption since. Despite the ambitious early plans for development in Angren, it appears that disappointing early results and lower than expected volumes and flows limited deployment there and elsewhere in the FSU (Stephens, 1980).

It is not clear why UCG declined after the 1970s. It has been suggested that the discovery of extensive natural gas deposits in the country siphoned off support for the UCG effort to build gas pipelines and other infrastructure. It is also possible that UCG ceased to be economically competitive with this new gas resource. It also may be that something did not work sufficiently well in Soviet UCG technology, and there is some evidence that the Soviets ignored recommendations of their own technical experts and made minimal use of diagnostics and modeling. Russia maintains technical expertise in UCG at the Russian Academy of Sciences in Moscow, and it is understood that one of the original schemes, developed in the Soviet era, is still in production.

North America

Between 1974 and 1989, North America was the site of major research and deployment efforts in UCG. This was largely driven by the OPEC oil embargo and increasing oil prices, and ended effectively with the 1986 drop in oil prices. During this time, the US conducted 33 pilots in Wyoming, Texas, Alabama, West Virginia, and Washington. These pilots were laboratories for major technology developments, including CRIP, reverse combustion, and validation of cavity growth models and gasification models. The Department of Energy sponsored much of this research, and Lawrence Livermore National Lab was a major participant, running 50 percent of the pilots. Much of this information can be found in Burton et al. (2006, in press).

In the US, recent activity has focused on Wyoming. In 2006, GasTech announced its plans to build and begin a UCG pilot in the Powder River Basin (PRB). In 2007, BP and GasTech announced a joint venture in which BP would assess the project for potential sponsorship of the field pilot. GasTech holds substantial acreage in the PRB overlying 16 billion tons of unmineable coal. According to their estimate (Wyoming Business Council, 2007; Morzenti 2007), over 307 billion tons of unmineable coal could be recovered with UCG. They also make economic calculations and a sensitivity analysis, and find the operating and capital costs for a UCG combined cycle plant to be much lower than surface IGCC equivalents.

The recent run-up in heavy oil production and upgrading in Alberta have brought renewed interest in UCG. Two companies, Laurus and Synergia Polygen, plan commercial UCG pilots. Both have bought acreage and are beginning to drill appraisal wells and submit permits for development.

It is noteworthy that all proposed North American projects have planned carbon capture and sequestration (CCS) into their base case. GasTech, BP, Laurus, and Synergia Polygen have announced plans for CCS, in some cases in combination with enhanced oil recovery.

OTHER COUNTRIES

In January, 2007, the South African power utility Eskom initiated a UCG pilot. ErgoExergy of Canada initiated the pilot which has been burning continuously since then. Since last summer, a 100 kw reciprocating engine has generated power from UCG SNG. The results have been extremely positive, and Eskom, the Ministry of Coal, and Ministry of Energy have announced plans to build a 2100 MW combined cycle plant to run entirely on UCG SNG. Following successful commercialization, additional plants are planned.

Feasibility studies have been undertaken recently by New Zealand, and a small trial burn was initiated at Huntley in 1994 with U.S. technical advice.

Pakistan and some Eastern European countries, like Ukraine and Romania maintain an interest in UCG, and developments may already be underway.

ENVIRONMENTAL MANAGEMENT

Future demonstrations will need to operate without creating any significant environmental impacts. Since previous UCG projects in the United States in the 1970s and 1980s, we have learned a great deal more about the behavior and types of contaminant compounds produced by UCG and have improved modeling capabilities to predict the complex geochemical-geomechanical-geohydrological framework within which UCG operates. The worldwide UCG experience demonstrates that avoidance of environmental contamination in future operations

can be achieved but should involve integration of criteria for site selection with choices of operating parameters.

Some of the steps that can be taken to avoid the situations that caused past groundwater pollution problems include:

- balancing operating conditions to minimize outward transport of contamination from greatly over-pressurized burn zones;
- ensuring UCG sites are situated where geologic seals sufficiently isolate the burn zone from surrounding strata;
- selecting sites with favorable hydrogeology to minimize widespread movement of the contaminated groundwater plume;
- isolating UCG locations from the current or future groundwater resources;
- if possible, removing liquid accumulations of undissolved pyrolysis products.

CARBON MANAGEMENT

Carbon capture and storage (CCS) has emerged as a key technology component to reduce greenhouse gas emissions, chiefly CO₂ through geological sequestration. Carbon dioxide can be stored in geological targets, usually as a supercritical phase. The chief geological targets for carbon storage include deep saline aquifers, depleted gas fields, active oil fields, (EOR), depleted oil or gas fields, and unmineable coal seams. All of these targets are frequently found near coal seams chosen for UCG. It has been noted repeatedly that opportunities for storage are often plentiful in coal basins (e.g., Schroeder, et al., 2001; Stevens, et al., 1998), therefore, it seems likely that storage options will co-exist with most, if not all, future UCG sites. Carbon capture economics and coincidence of storage targets make UCG-CCS an attractive carbon management package.

Effective sequestration of CO₂ from UCG operations can be provided immediately for conventional sequestration targeted, such as saline formation or depleted oil and gas fields. UCG SNG does not prevent any unusual chemical or physical property that would present an obstacle or conventional separation technologies or sequestration practice. Numerous documents describe the current knowledge regarding science practices, and operational

guidelines for carbon capture sequestration that would apply to CO₂ captured from UCG operations.

NOTE: All material summarized from Burton, E, Friedmann, SJ, Upadhye, R, in press, Best Practices in Underground Coal Gasification, Lawrence Livermore National Laboratory Report # UCRL-TR-225331-DRAFT, 119 pp.

Chapter Seven

Turning Coal into Pipeline Quality Natural Gas

The United States' growing demand for natural gas is forecast to continue to exceed our capacity to produce natural gas domestically. This presents an energy security problem, as the broadly proposed alternative is imports of Liquefied Natural Gas (LNG) from countries that may be politically unstable. The production of natural gas from abundant, domestically produced coal, however, provides a clean, competitive, and secure alternative. In fact, studies show that natural gas produced from coal with carbon capture and storage has a smaller carbon footprint than LNG production. The March 2006 report from the National Coal Council (NCC) reported that technologies exist to convert coal into 4 trillion cubic feet (TCF) of natural gas annually by 2025

FINDINGS

The NCC finds the following:

4. The United States' growing demand for natural gas is forecast to continue to exceed our capacity to produce natural gas domestically. This presents an energy security problem, as the broadly proposed alternative is imports of LNG from countries that may be politically unstable.
5. The production of natural gas from abundant, domestically produced coal provides a clean, competitive and secure alternative.
6. Technologies exist to convert coal into 4 TCF of natural gas annually by 2025.

RECOMMENDATIONS

The NCC recommends the following:

4. The United States must take steps now to remove the key barriers to implementation of projects to produce natural gas from coal, namely: environmental permit approval, financing risk, and carbon sequestration solutions.
5. Some incentives should be made available to the first group of projects to overcome the increasing capital costs. These incentives should include investment tax credits and Federal loan guarantees.

6. Additional funding should be utilized to accelerate demonstration of carbon sequestration.

INTRODUCTION TO TECHNOLOGY OPTIONS FOR CONVERTING COAL TO SUBSTITUTE NATURAL GAS

As Figure 7.1 illustrates, experts forecast that there is an increasing short supply of natural gas relative to growing demand. With coal as an abundant U.S. energy source, options to convert coal to natural gas can play a strategic role in future energy security.

Gasification Process and Reactor Designs

Conversion of coal into substitute natural gas (SNG) begins with a gasification process to break down the solid coal feedstock into gaseous components. Specifically, gasification is the partial oxidation of the coal feedstock into SNG, which is made up of predominantly hydrogen (H₂) and carbon monoxide (CO).^{xxii} Gasification systems can convert any carbon-based feedstock (coal, petroleum coke, heavy oils, wastes, or biomass) into SNG by creating a high-temperature and high-pressure environment and controlling how much fuel and oxygen are fed into the process. After SNG is produced through gasification processes, the SNG can be converted into SNG by removing impurities and methanating the SNG. Impurities are removed in acid gas removal technologies such as chemical and physical absorption. Methanation essentially involves reacting the SNG over a nickel oxide catalyst.

Domestic Natural Gas Production Falling Short of Demand

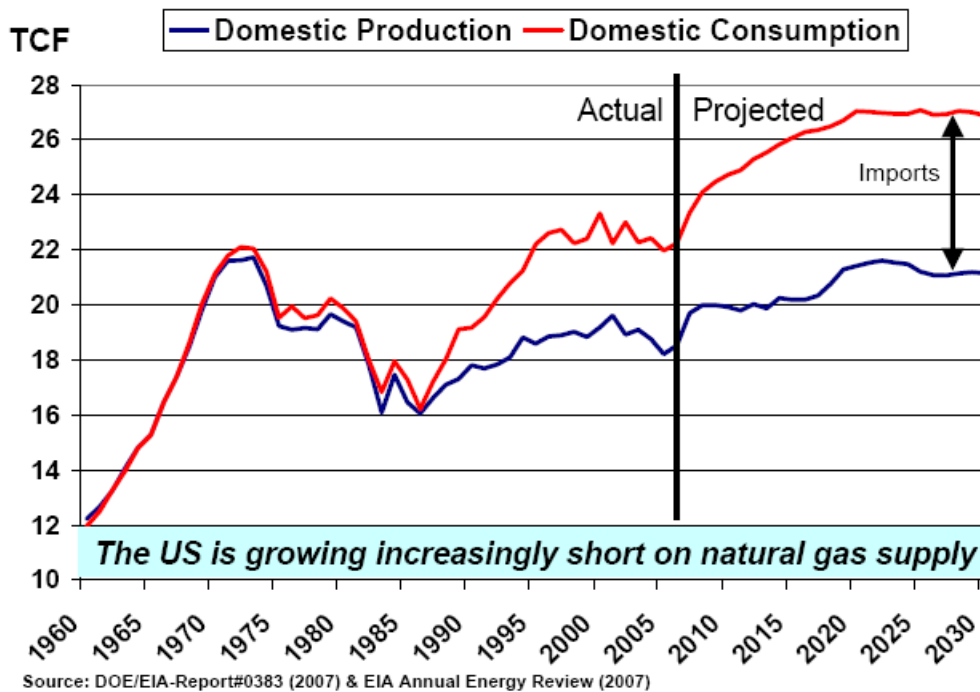

Figure 7.1. Rate of Supply and Demand of U.S. Natural Gas

There are three basic gasification designs:

1. Moving-bed reactors: Also called fixed-bed reactors, this process involves large particles of coal move slowly down through the gasifier while reacting with gases moving up through it. Several different “reaction zones” are created that accomplish the gasification process.
2. Fluidized-Bed Reactors: Fluidized-bed reactors efficiently mix feed coal particles with coal particles already undergoing gasification in the reactor vessel. Coal is supplied through the side of the reactor, and oxidant and steam are supplied near the bottom.
3. Entrained-flow Reactors: Entrained-flow systems react fine coal particles with steam and oxygen and operate at high temperatures. Different systems may use different coal feed systems (dry or water slurry) and heat recovery systems. Entrained-flow reactor designs are the most common designs available currently in the marketplace.

Commercially Available Gasification Technologies

There are a number of different gasification technologies that could be used for the production of SNG. Prominent technologies available in the marketplace are those from ConocoPhillips, GE Energy, SASOL-Lurgi, Shell, and Siemens. There are also technologies under development by GreatPoint Energy and Kellogg Brown & Root. Each of these technologies is discussed briefly below.

ConocoPhillips

Originally developed by Dow Chemical, the E-Gas process used by ConocoPhillips, involves a slurry-fed, entrained-flow, oxygen-blown, slagging gasifier with a unique two-stage operation. In the E-Gas two-stage design, the coal slurry is fed with high-purity (>95 percent) oxygen into the first stage of the gasifier, which operates at high temperature and pressure. The hot raw gas from the first stage enters the second stage, where additional coal slurry is injected. The second stage operates at lower temperature and produces SNG that can then be sent to clean-up and methanation systems.

The ConocoPhillips process was originally demonstrated at the Louisiana Gasification Technology, Inc. (LGTI) plant in Plaquemine, Louisiana. That plant was an integrated gasification combined cycle (IGCC) facility that operated on sub-bituminous coal. Subsequently, the E-Gas technology was used at the Wabash River coal gasification repowering project, which was selected for funding in 1991 by DOE under the Clean Coal Technology Demonstration program. The design at the Wabash facility was based on the LGTI gasifier, using an E-Gas system as part of a 265MW IGCC configuration. The Wabash IGCC facility has operated since 1995.

ConocoPhillips currently offers E-Gas gasification systems in the marketplace for use in IGCC, SNG or other gasification applications. An advantage of the system is its proven operation on both bituminous coal (at Wabash) and sub-bituminous coal (at LGTI). The two-stage operation of the system also leads to improved efficiency and reduced oxygen requirements relative to single stage systems.

GE Energy

In 2004, GE Energy (formerly Texaco and ChevronTexaco) acquired the gasification process technology developed by Texaco. The GE technology uses a single-stage, entrained flow, oxygen-blown gasifier in which coal slurry and high-purity (> 95 percent) oxygen are fed to a hot pressurized gasifier. The technology has three different configurations related to how the system cools the raw SNG leaving the gasifier vessel:

1. **Quench:** In this configuration, the hot SNG exiting the gasifier is quenched by a spray and pool of water to reduce its temperature before entering the SNG cleanup processes. The quench design is the simplest and lowest capital cost design, but is less efficient than the other designs because less heat is recovered in the SNG cooling process. Quench gasifier designs are well suited for SNG production where capture of excess steam for power generation is less important and where water needs to be added for the subsequent water gas shift reaction anyway.
2. **Radiant Only:** In this configuration, the hot SNG exiting the gasifier passes first through a radiant SNG cooler and then through a water quench prior to entering the SNG cleanup processes. Relative to the quench configuration, the radiant design offers improved overall process efficiency, but higher capital cost. This configuration was selected by GE and Bechtel for the design of their reference IGCC plant.
3. **Radiant-Convective:** In this configuration, the hot SNG exiting the gasifier passes through a radiant SNG cooler then over a pool of water to remove particulate, but the SNG is not quenched). Then it goes through a convective cooler where the SNG is further cooled prior to entering additional heat exchangers or cleanup systems. This configuration has the highest capital cost, but also the highest overall efficiency. This is the configuration used originally at Tampa Electric's Polk Power Station.

Initial development of the GE technology was conducted in the 1940s at Texaco's Montebello, California laboratories. The first commercial facility using the technology was built for Eastman at Kingsport, Tennessee, and started operation in 1983. In 1984, the first IGCC plant using GE technology was operated at the Cool Water facility. The gasifier from Cool Water was subsequently relocated to Coffeyville, Kansas where it operates today as part of an ammonia fertilizer facility.

The Tampa Electric IGCC Clean Coal Technology Demonstration Project built in Polk County, Florida uses a GE radiant-convective design. This facility was developed to build on the Cool Water experience and commercially demonstrate the use of the GE (then Texaco) coal gasification process in a commercial-scale IGCC plant. The Polk plant is a 250 MW facility that began operating in 1996 and continues operating today.

An advantage of the GE technology is the extensive operating experience at full commercial scale. In addition, the quench technology offers a relatively low capital cost alternative with significant commercial operating experience that may offer advantages for SNG production. On the down side, the GE process is less suited to economically handle low-rank coals relative to other gasifier designs, including entrained-flow gasifiers with dry feed. GE has been developing technologies to improve performance on low rank coals that may eliminate this disadvantage in the future.

Lurgi originally developed gasification technology in the 1930s as a means of producing town gas. The Lurgi dry ash gasifier is a pressurized, dry ash, moving-bed gasifier. This gasification system operates on lump coal rather than pulverized fuel and operates at sufficiently low temperature that the ash does not melt to create slag, but rather is removed as a dry product. This technology is well suited for use with low rank lignite and sub-bituminous coals, but creates tar residues that complicate clean-up processes. Significant installations of this technology include the Great Plains SNG plant in North Dakota and the SASOL synfuels plant in South Africa.

Shell Global Solutions

Shell Internationale Petroleum Maatschappij B.V. began work on coal gasification in 1972 and the company tested pressurized, entrained-flow, slagging coal gasifiers in the 1970s and early 1980s. Based on the experience it gained with these testing initiatives, Shell built a demonstration unit at its oil refinery and chemical complex in Deer Park, Texas, near Houston. This new unit, commonly called SCGP-1 (for Shell Coal Gasification Plant-1), was designed to gasify bituminous coal and high-moisture, high-ash lignite.

In spring 1989, Shell announced that its technology had been selected for the large commercial-scale Demkolec B.V. IGCC plant at Buggenum, in The Netherlands. This plant generates 250 MW of IGCC electricity with a single Shell gasifier.

The Shell system uses a dry-feed system, rather than slurry-fed system and it utilizes a water wall inside the gasifier to protect it, rather than a brick refractory as is used by GE and ConocoPhillips technologies. One of the primary advantages of Shell technology is its ability to handle a wide variety of coals, including low rank sub-bituminous and lignites, and the water wall helps reduce O&M expenditures. However, use of the Shell technology is generally estimated to require higher initial capital expenditures than other gasification processes.

Siemens

In 2006, Siemens acquired gasification technology owned by Future Energy. The technology, originally developed by Deutsches Brennstoffinstitut Freiburg, is a dry feed, entrained-flow, slagging process. The

dry fed system is able to handle a wide variety of coals. The Siemens technology also uses a water-cooled system that enables the gasifier to be operated with or without a refractory liner. The gasifier can be designed with partial- or full-quench capability. The technology was successfully used beginning in 1984 at the SVZ Schwarz Pumpe facility in Germany and demonstrated operation for over six years on lignite feedstock.

GreatPoint Energy

GreatPoint Energy is working to demonstrate its technology at commercial scale. The technology is different than other gasification systems in that it produces SNG in a single step called catalytic coal methanation, rather than first producing SNG and then producing SNG. The system works by adding a catalyst to the coal gasification system, which reduces the operating temperature in the gasifier and directly promotes reactions that produce SNG. The catalyst is made up of a proprietary mix of low-cost metal materials designed to promote gasification at low temperatures and is continuously recycled and reused within the process. Commercial-scale versions of the technology are not yet available, but GreatPoint Energy is currently developing a demonstration-scale facility in Fall River, Massachusetts.

KBR

The KBR Transport Gasifier is an advanced circulating fluidized bed reactor designed to operate at higher circulation rates, velocities, and riser densities than a conventional circulating fluidized bed and it is targeted at lower rank coal feedstocks. The Transport Gasifier is based on KBR's fluid bed catalytic cracking experience. The system has been operated at a test facility in Wilsonville, Alabama since 1996. This system was selected for use in a 300 MW IGCC DOE demonstration project to be built by Orlando Utilities and Southern Company, but that project has since been abandoned.

Methanation

Methanation is the production of methane from carbon monoxide and hydrogen. Traditionally, there have been numerous efforts to commercialize this process, but there are two predominant technology licensors today. Haldor Topsoe produces a catalyst selective for producing methane. The CO and CO₂ in the substitute gas is converted effectively by the methanation reaction. During the last decade, the typical operating temperature for the methanation catalyst has gradually drifted downwards. This is due to more efficient shift catalysts and more efficient CO₂ removal systems. However, at lower operating

temperatures many plants have experienced high CO and CO₂ leakage from the methanator when using traditional catalysts.

Topsoe's PK-7R methanation catalyst is developed to operate at low temperatures ensuring that CO and CO₂ are fully converted at inlet temperatures down to 190°C/375°F. The superior activity and capability of PK-7R to operate at low temperatures are a result of optimized catalyst production technology.

The only coal to SNG plant in North America (Dakota Gasification Company) uses Lurgi fixed-bed coal gasifiers and Lurgi's Rectisol® process, along with a number of other Lurgi technologies, including Lurgi's methanation technology.

QUALITY CONSIDERATIONS AND THE STATE OF IMPLEMENTATION

Natural gas produced by gasification is generally added to interstate pipelines that have approved standards for the quality of the natural gas. In particular, the natural gas must meet minimum heating value levels. Natural gas from gasification is predominantly methane has a lower heating value than typical pipeline natural gas which contains small concentrations (1-3 percent) of ethane and propane. As a result, the process must be designed to optimize the heating value of the product. Specifically, inerts with no heating value that carry through the SNG clean-up section also pass through the methanation plant and end up in the natural gas product, so efforts must be taken to minimize the inerts in the SNG feed. Moisture limitations may also require supplemental drying to the substitute natural gas product. Some pipeline specifications have a hydrogen limit that will require control of unreacted hydrogen. And finally, sulfur limits in pipeline specifications are low. However, sulfur deactivates the catalyst used in methanation, so gas clean-up prior to the catalyst beds of the methanation plant generally reduces sulfur content below pipeline specification levels.

In terms of implementation of this technology, gasification has been in commercial use for more than fifty years as a process technology for the refining, chemical, and power industries. In 1999, the first World Gasification Survey was conducted by the firm of SFA Pacific with support from the U.S. Department of Energy and in cooperation with the member companies of the Gasification Technologies Council. The survey identified and gathered information on 160 commercial gasification plants in operation, under construction, or in planning and design stages in twenty-eight countries in North and South America, Europe, Asia, Africa and Australia.

The total daily capacity of these facilities when in operation will be just less than 430 million normal

cubic meters of substitute gas (SNG). This is the energy equivalent of more than 770,000 barrels of oil per day, as one million normal cubic meters of SNG is the equivalent of 37.3 million standard cubic feet, or 10.4 billion Btus.

The results of the survey reveal a worldwide industry undergoing significant growth and change.

STATE OF THE INDUSTRY

Regional Distribution of Gasification Capacity

The largest concentrated source of gasification capacity in the world is provided by the three Sasol plants in South Africa, which accounted for just over 31 percent of total world capacity at the end of 1999. The plants produce transportation fuels and chemicals from coal. Over the 2000-2005 time period, the construction of new capacity in Europe/Former Soviet Union, Asia/Australia and North America will provide greater regional, feedstock and product diversification (see Figure 7.2).

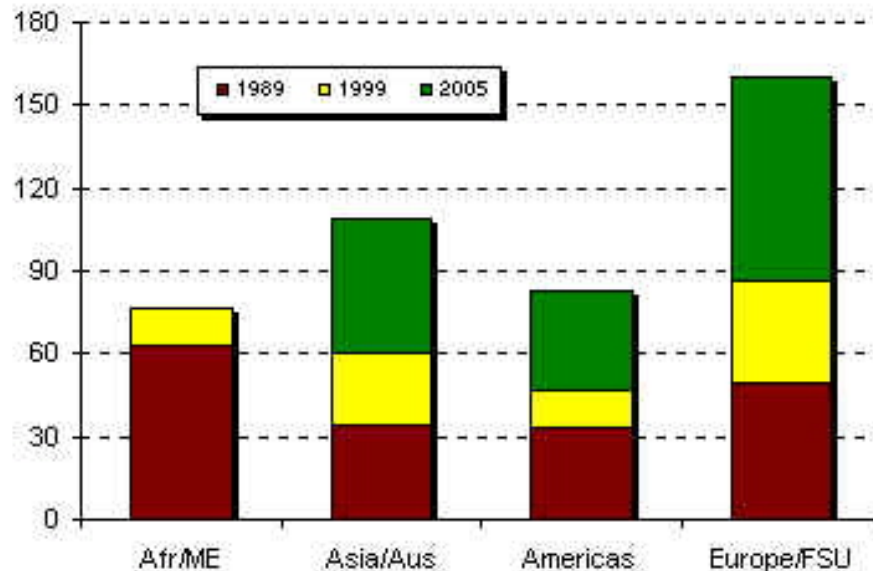

Source: www.gasification.org

Figure 7.2. Regional Distribution of Gasification Capacity

Ten nations accounted for 99 percent of the gasification-based SNG capacity added worldwide during the decade of the 1990s (see Figure 7.3).

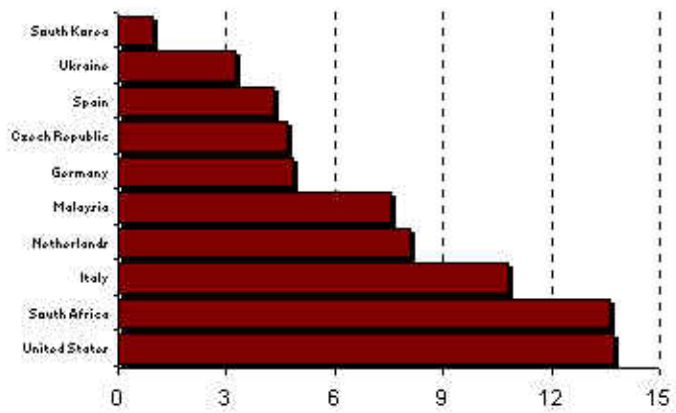

Source: www.gasification.org

Figure 7.3. National Production of Gasification-Based SNG in 1990s

Products of Gasification

Historically, SNG from gasification has been used primarily as a feedstock for the production of chemicals. In 1989, chemical production accounted for almost one-half of SNG use worldwide. This is changing as more power generation projects are being constructed and planned. The overwhelming majority of the post-1990 new capacity in the industry has been devoted to the production of chemicals and power: 66 in the 1990s and 94 for post-2000 plants. However, the mix between chemicals and power production changes noticeably from the 1990s to the post-2000 period.

For new capacity added between 1990 and 1999 the power-to-chemicals SNG volume ratio was approximately 1.4:1. The post-2000 ratio is projected to be almost 3:1 in favor of power generation, reflecting increasing electricity demand and deregulation of electricity markets around the world. However, the recent slowdown in the coal-based power generation market due to climate change concerns may alter the near-term forecast in favor of industrial applications of gasification once again (see Figure 7.4).

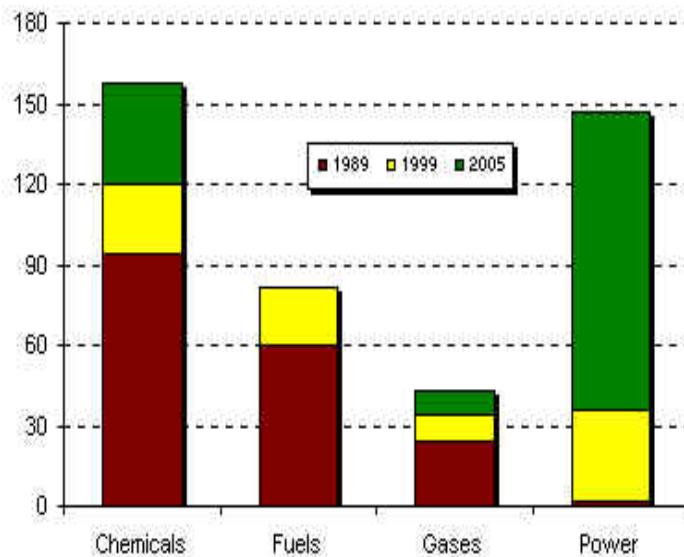

Source: www.gasification.org

Figure 7.4. World Gasification Capacity by Primary Product

(Million Normal Cubic Meters of SNG Per Day)

Trends in Raw Materials

Coal and petroleum-based materials provide the vast majority of feedstocks for world gasification capacity. Eighty percent of the capacity added between 1990 and 1999 was based on these two feedstocks. That number will rise to 94 percent for post-2000 capacity additions. Petroleum-based materials (including residual oil, petcoke, tars, etc.) continue to grow in importance, driven by refining industry economics, more stringent environmental regulations, and electricity deregulation that allows refinery-based power to compete in decontrolled markets.

Petroleum-based capacity added in the 1990s was approximately 60 of coal capacity; however, post-2000 petroleum-based capacity growth will be more than 180 percent of that based on coal (see Figure 7.5).

Growth in the Industry, 1900-2005

Over the ten year period between 1990 and 1999, world gasification capacity grew by 50 percent, with forty-three new plants coming on line and the Sasol plants in South Africa increasing their capacity by almost one-quarter. Over the period between 2000 and 2005, growth is forecast to accelerate, with another forty-one plants expected to start up, expanding capacity by an additional 58 percent, an annual growth rate of just under 10 percent.

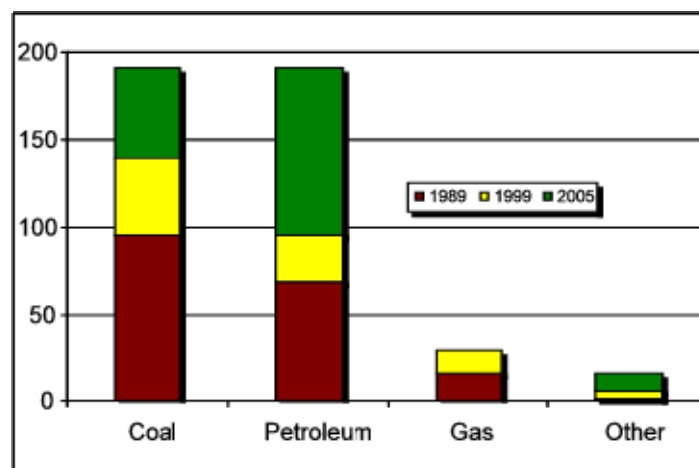

Source: www.gasification.org

Figure 7.5. World Gasification Capacity by Primary Feedstock
(Million Normal Cubic Meters of SNG Per Day)

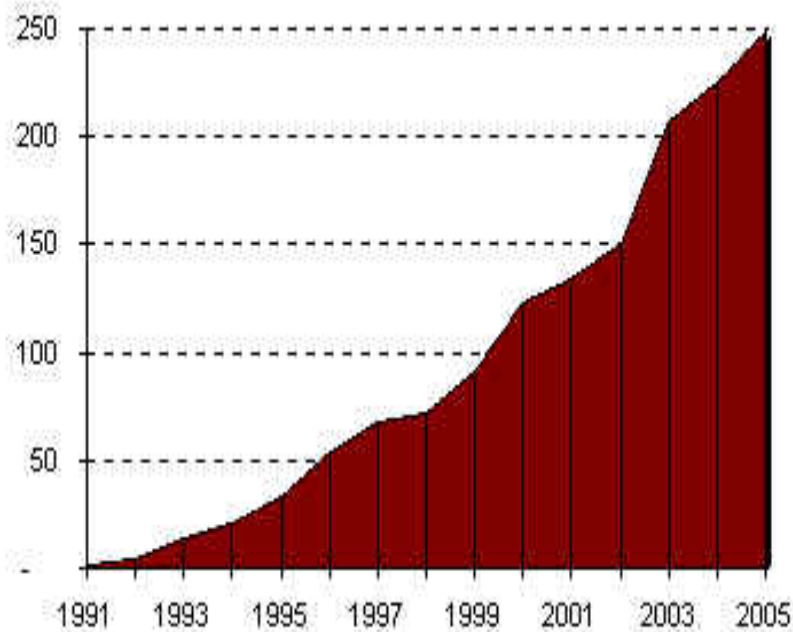

Source: SFA Pacific for U.S. DOE, GTC Analysis

Figure 7.6. Growth of Industry, 1990-2005

CURRENT PROJECTS FOR PRODUCTION OF NATURAL GAS

There are currently fifteen “coal-to-substitute-natural-gas” projects in various stages of planning through to operation in the United States. There is a project in the startup and optimization phase in both China and the Czech Republic. The most notable project in current operation is operated by the Dakota Gasification Company, sponsored initially by the Department of Energy. The Great Plains Synfuels Plant of Dakota Gasification Company began operation in 1984, and currently produces more than 54 billion standard cubic feet of substitute natural gas annually. The gas is delivered via pipeline to the Northern Border Pipeline, which transports the gas to thousands of homes and businesses in the

eastern United States. Natural gas produced at the Great Plains Synfuels Plant averages about 975 Btu per cubic foot. The DOE provided loan guarantees for the original construction.

Other projects in permitting through construction stages include:

Indiana Gasification, LLC

Indiana Gasification is developing a facility in Southwest Indiana that would convert about 3.2 million tons of Illinois Basin coal into SNG. The project has a site along the Ohio River and would produce about 40 Bcf of SNG that will be sold under contract to gas and electric utility companies. Carbon dioxide will be captured at the facility and either sold for enhanced oil recovery or used to demonstrate carbon sequestration in nearby geologic formations, assuming appropriate incentives and regulatory frameworks are in place.

Midwest SNG

Peabody Energy, the largest coal producer in the United States, and ConocoPhillips are evaluating a commercial scale coal to natural gas plant in Kentucky that would use the ConocoPhillips' E-Gas gasification technology. The project would be located at a mine-mouth coal production facility and would be designed to produce 50 -70 billion cubic feet of natural gas per year from more than 3.5 million tons per year of Midwest coal. The project would provide for carbon capture and storage, presuming a supportive regulatory framework is in place.

Power Holdings, LLC

This planned facility would produce natural gas from approximately 3.5 million tons per year of Illinois Basin coal. The gasification process will use GE Energy technology. The site selected for the facility is in Mt. Vernon, Illinois. Carbon dioxide will be captured and used for Enhanced Oil Recovery.

Steelhead Energy

This facility, also known as Southern Illinois Clean Energy Center will use the ConocoPhillips E-Gas technology to produce natural gas.

Secure Energy, LLC

This facility to be located in Decatur, Illinois will be the first U.S. commercial application involving Siemens gasification technology.

Lake Charles Cogeneration, LLC

This facility to be located in Lake Charles, Louisiana will use GE gasification technology and will co-produce SNG and hydrogen. The project was recently issued \$1 billion in tax-free GoZone bonds to help support the \$1.6 billion project.

REFERENCES

U.S. DOE/NETL. "Major Environmental Aspects of Gasification-Based Power Generation Technologies," December 2002, p. 1-7

Gasification Technologies Council, www.gasification.org

-
- ⁱ As part of its 9/28/07 labor agreement with the UAW, GM committed to begin manufacturing the “Volt” in 2010.
- ⁱⁱ The convention is to designate the electricity-only range of a PHEV as a numerical suffix. Thus a PHEV with an electricity-only range of 40 miles would be designated as a PHEV40.
- ⁱⁱⁱ Instead of operating on electricity alone until its charge drops, a PHEV may be designed to operate in a “blended” mode in which both the battery motor and internal-combustion engine are operated intermittently.
- ^{iv} A commercial BEV is being sold in the U. S. that accelerates from 0 to 60 mph in under 4 seconds:
http://www.teslamotors.com/performance/perf_specs.php
- ^v The term “utility factor” refers to the percentage of miles a PHEV would be driven using battery power alone.
- ^{vi} The sales in 2006 were influenced by a tax credit in the Energy Policy Act of 2005 for vehicles purchased after 1/1/2006. The credit was phased out for a given manufacturer after a certain number of its vehicles were sold. As a result, the credit for Toyota hybrids (which made the most popular models) was phased out beginning on 10/1/2007.
- ^{vii} To date, six manufacturers have received qualification (GM, Ford, Toyota, Honda, Nissan, Mazda).
- ^{viii} A reduced tax credit is available to purchasers of qualifying vehicles for 18 months after the manufacturer reaches the 60,000 threshold.
- ^{ix} Samaras used a logistic (sigmoidal) model, with specific assumptions about initial sales and growth rate to match the EPRI-modeled fleet levels in 2030 and 2050.
- ^x For example, EIA’s analysis of the McCain-Lieberman bill^x projects allowance prices of \$18-78/tonne CO₂ in nominal dollars over the 2010-2030 time frame. In their analysis of the Bingaman/Specter bill, EIA reports that “[t]est simulations with the NEMS transportation model were conducted to find an allowance price, beginning in 2012, that would induce consumers and manufacturers to change their behavior such that they achieve an average fuel economy for new light-duty vehicles of 35 miles per gallon by 2020. An allowance price of \$325 a ton ... was found to be the minimum that would achieve this objective.”
- ^{xi} EIA projects that world unconventional production (including oil sands, bitumen, biofuels, coal-to-liquids, and gas-to-liquids) will increase by 9.7 million barrels between 2003 and 2030, representing 25 percent of the total world liquid fuel supply increase. See EIA.
- ^{xii} The estimates in Figure 5.6 differ based on the degree of aggressiveness assumed in the studies concerning CTL development efforts. For example, the SSEB study examined options for eliminating U.S. oil imports by 2030, and the NETL study assumed a crash effort beginning in 2006 to address peak oil concerns.
- ^{xiii} The Air force tests were conducted with JP8, the standard military jet fuel. However, Pennsylvania State University’s Energy Institute has developed a coal-based “JP900” fuel for use in high-performance military aircraft, which could also be used in commercial jetliners. Combustion tests have shown that JP900 meets or exceeds almost all specifications for military JP8 and commercial Jet A jet fuels. Depending on the results of the ongoing tests, synthetic fuels could ultimately replace all conventional oil-based fuels for the entire military. See Putrich.
- ^{xiv} For example, American Airlines, which uses more oil annually than the country of Ireland and where 28 percent of the factor input costs are for energy, experiences a \$33 million increase in cost for every penny a gallon increase in the price of jet fuel, and in 2006 paid \$2.4 billion more (34 percent) for fuel than in 2004.
- ^{xv} The MTG process by shape selective zeolite catalysis was discovered in the early 1970s by Mobil Research and Development Corp. (MRDC, now ExxonMobil Research and Engineering Company, EMRE) which had a predominant position in zeolite catalysts at that time. The process was further developed to the pilot plant stage (capacity of about 4 bpd). In the early 1980s a 100 bpd demonstration plant was developed and built at Union Rheinische Braunkohlen Kraftstoff AG Wesseling, Germany (URBK).
- ^{xvi} Developers realize that there are only a few commercially proven and therefore financeable FT technologies in the world, and some of the most recognized of these are not being made readily available. As a result, a number of U.S. CTL project developers, including DKRW and Headwaters, have switched from FT in favor of methanol synthesis and a downstream ExxonMobil system to convert methanol to high quality gasoline.
- ^{xvii} In a DOE/NETL study on the economic impacts of developing alternative liquid fuels to those derived from oil, various options were considered. The CTL option was considered on the basis of a major crash program to provide an alternative fuel source. Liquid fuels production begins at 300,000 bpd in year 5 as the first three plants come on line and liquid fuels production increases linearly as three new CTL plants come on line annually. After year 11, liquid fuels production from CTL totals 2 million bpd and after year 21 it totals 5 million bpd. This should be

compared with the U.S. current consumption of 21 million bpd. The cumulative costs over a 20-year period would be approximately \$700 billion, and the construction of new plants would be ongoing if oil-based fuels were to be replaced. While this was only an assessment exercise, it illustrates the scale of the investment required to replace a significant proportion of liquid fuels. See Bezdek, Wendling, and Hirsch.

^{xviii} These states include Alaska, Arizona, Idaho, Illinois, Indiana, Kentucky, Minnesota, Ohio, Pennsylvania, Texas, Wyoming, and West Virginia.

^{xix} The current size of a unit coal train is approximately 125 cars, each hauling 120 tons of coal and stretching about one mile. A unit train hauls about 15,000 tons of coal. One ton of coal can produce about two barrels of CTL.

^{xx} A comprehensive lifecycle analysis would also include greenhouse gas emissions from mining the coal and transporting the liquid product.

^{xxi} An EPA analysis concluded that the mine-to-wheels GHG emissions of CTL, if there was no CCS at the plant, was 119 percent more than the equivalent well-to-wheels GHG emissions of conventional petroleum, declining to four percent more than conventional petroleum with carbon controls at the plant

^{xxii} SNG also contains some carbon dioxide (CO₂), moisture (H₂O), hydrogen sulfide (H₂S) and carbonyl sulfide (COS) as well as small amounts of methane (CH₄), ammonia (NH₃), hydrogen chloride (HCl) and various trace components from the feedstock.